

# LYSON

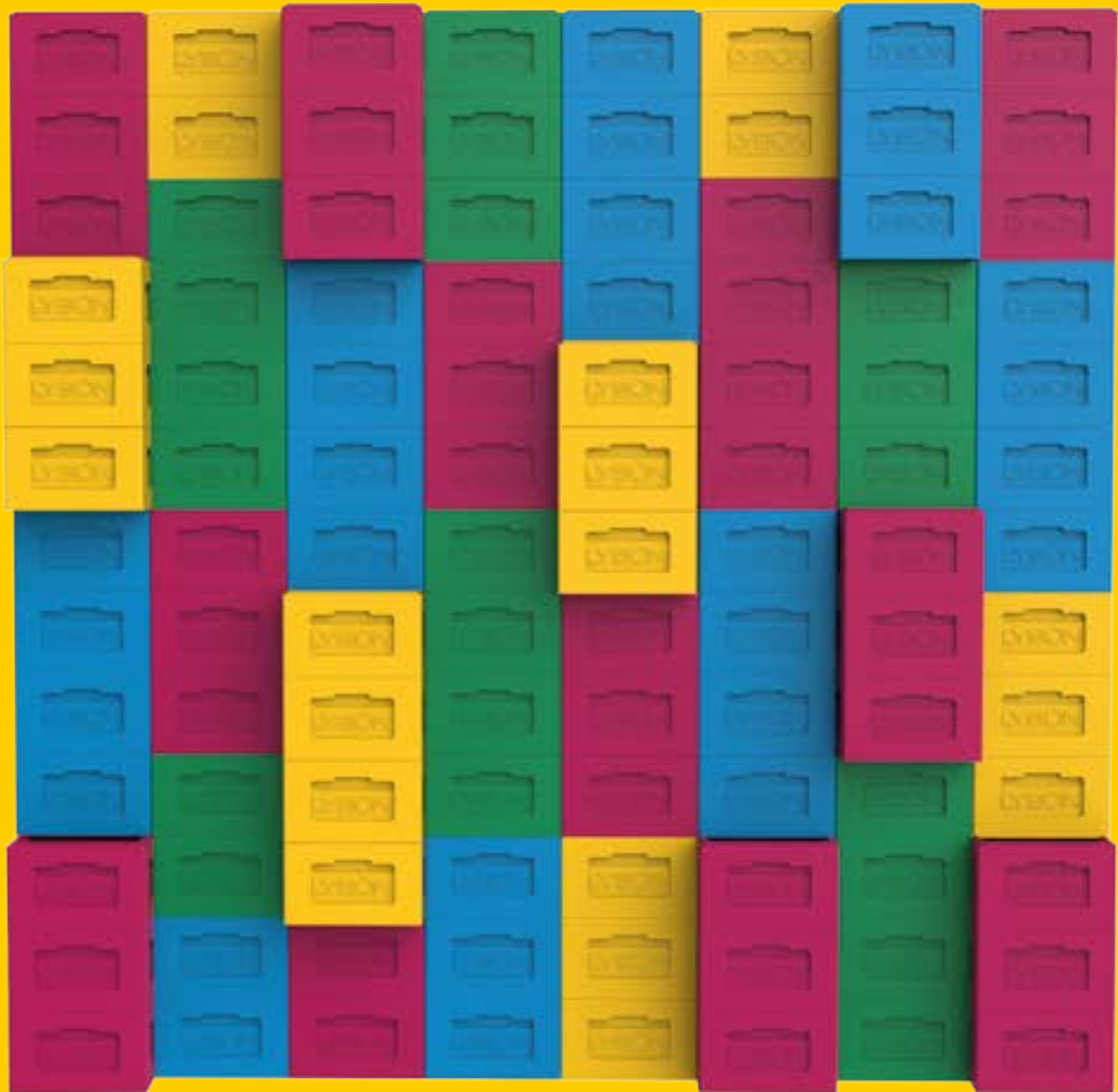

Product Catalogue

# 2025/2026

30 LYSON



Made in  
Poland

<b>HONEY EXTRACTORS</b> .....	<b>29</b>
TANGENTIAL HONEY EXTRACTORS .....	30
RADIAL HONEY EXTRACTORS.....	45
CASSETTE HONEY EXTRACTORS.....	59
OTHER HONEY EXTRACTORS.....	84
CONTROLLERS AND ADDITIONAL OPTIONS FOR EXTRACTORS .....	89
<b>HONEY PROCESSING</b> .....	<b>95</b>
AUTOMATIC HONEY EXTRACTION LINES .....	96
HONEY UNCAPPING.....	99
HONEY DRYERS .....	110
HONEY FILTRATION .....	113
HONEY CREAMING.....	115
HONEY PUMPING.....	120
HONEY SETTLING TANKS .....	122
HONEY DOSING.....	129
HONEY DECRYSTALLIZATION .....	134
<b>WAX MELTING</b> .....	<b>137</b>
<b>POLLEN PROCESSING</b> .....	<b>148</b>
<b>BEEHIVES &amp; BEEHIVE ELEMENTS</b> .....	<b>153</b>
<b>QUEEN'S BREEDING</b> .....	<b>179</b>
<b>BEEKEEPING TOOLS</b> .....	<b>186</b>
<b>CLOTHING FOR BEEKEEPERS</b> .....	<b>186</b>
CLOTHING FOR BEEKEEPERS COLOR & PREMIUM LINE .....	206
CLOTHING FOR BEEKEEPERS CLASSIC LINE .....	212
CLOTHING FOR BEEKEEPERS OPTIMA LINE .....	217
KIDS CLOTHING .....	218
<b>APIKAND BEE CANDY &amp; SYRUP</b> .....	<b>224</b>
<b>SILICONE MOLDS AND CANDLE</b>	
<b>MAKING ACCESSORIES</b> .....	<b>226</b>
<b>BEE &amp; LOVE</b> .....	<b>235</b>
<b>BEE &amp; SOAP</b> .....	<b>236</b>
<b>PASIEKA OFFER</b> .....	<b>240</b>
LABELS .....	241
JARS .....	243
<b>BEE-THEMED EDUCATIONAL MATERIALS</b> .....	<b>246</b>

# LYSON

## A BIT OF HISTORY

LYSON is a brand built on a passion for beekeeping, brought from the family home. 30 years of experience in the beekeeping industry allows us to create modern solutions that respond to the changing needs of beekeepers around the world. From the very beginning, we have been focusing on the quality and functionality of our products. When developing the assortment, we do not forget about the comfort of use in all conditions – from small hobby apiaries to professional apiary farms. Today, LYSON is synonymous with innovative hives and apiary equipment appreciated globally. Thanks to our close relationships with customers and the ability to listen to their needs, we are constantly introducing new technologies that set the direction for the development of the beekeeping industry in the 21st century. Our mission is to support the beekeeping of the future – modern, conscious and sustainable.

### Success

The basis of our success is the commitment of the entire team, which constantly strives to provide the highest quality of products and services. We proudly participate in numerous competitions and polls, winning prestigious awards such as Best Managed Companies by Deloitte. Our innovations have been awarded at the Apimondia world congresses (Ukraine, Korea, Canada, Turkey, Chile), where we have already won a total of 42 medals in various categories by 2023. In 2021, we became a partner of the European Beekeeping Conference BEECOME, and Tomasz Łysoń received the special EY Entrepreneur of the Year award. A year later, we received the title of Friendly Workplace, and in 2023 the Forbes Diamonds. In 2024, our honey extractors were honoured with the Teraz Polska emblem. Each award is a motivation for us to further development.



### Additional activities

LYSON is much more than a manufacturer of beekeeping equipment. In 2018, we opened the Apilandia Interactive Beekeeping Center in Klecza Dolna, Poland – a unique educational place that has already been visited by over 120,000 people. We believe that education is the first step to protecting bees. In 2019, we established the Apikultura Foundation, which supports beekeepers in difficult situations – among other things after the flood of 2024 by providing aid and equipment. We are socially involved – the "Thank the Bee" campaign is our way of reminding how important bees are for the ecosystem and everyday life. Through training, cooperation with scientists and specialists, we promote knowledge, responsibility and care for the environment. We are a social movement, a community of enthusiasts and a partner of everyone who wants to act for the protection of pollinators. Our activities show that LYSON is a brand with a mission – to create, educate and inspire for the good of bees and people.





## Honey extractors

Honey extractors with manual or electric drive. Depending on the selected model - plastic or stainless steel valves.

Available in various versions, SAF NATURA honey extractors features a drum diameter **from 420 mm to 900 mm**, allowing you to precisely match the equipment to the size and needs of your apiary.



## Honey sieves



A wide range of honey sieves with diameters **from 320 mm to 620 mm**, made of high-quality stainless steel.

## Uncapping tables



They are perfect for apiaries where many frames are uncapped during honey harvesting.

## Wax melters



Crafted from high-quality stainless steel, SAF Natura wax melters ensure reliable performance and easy maintenance for every beekeeper.

## Settling tanks

SAF Natura settling tanks with a capacity of **30 kg to 400 kg**, designed for storing and clarifying honey.



## Stands for settling tanks

Designed for honey settling tanks, they are made of high-quality stainless steel.



Scan the QR code  
and see what we offer!



# OUR WINNING PRODUCTS

AT APIMONDIA



**ACTIVE CARBON SOAP**

APIMONDIA 2023



**BEESWAX CANDLE**

APIMONDIA 2023



**BODY BUTTER**

APIMONDIA 2022



**BEESWAX CANDLE**

APIMONDIA 2022



**PEELING SOAP**

APIMONDIA 2022



**BEE BUTTER**

APIMONDIA 2019



**ROSE SOAP**

APIMONDIA 2022



**HAND CREAM**

APIMONDIA 2015

# THE SWEETEST THING



- PRALINES
- TRUFFLES
- GRANOLA
- CHOCOLATES
- HONEY FUDGE
- GRANOLA BARS
- HONEY TRUFFLES
- NUT CREAMS & JAMS
- GINGERBREAD SELECTION
- FRUITS & NUTS COVERED IN CHOCOLATE



# I LOVE GRANOLA BAR



THE MIODOWY KŁOS BAR  
SERIES IS THE WINNER OF  
THE PRESTIGIOUS  
TERAZ POLSKA  
COMPETITION

AWARD WINNING HONEY SNACKS



TERAZ POLSKA

# HONEY THERAPY



- SOAPS
- BODY SCRUB
- HAND CREAM
- FOOT CREAM
- BODY LOTION
- BODY BUTTER
- BATH COSMETICS
- GOLDEN SPA SERIES
- 100% NATURAL SERIES
- FACE CARE COSMETICS



# NEW ARRIVALS

## 2025

# MULTI-FRAME

## NEW LINE OF BEEHIVES!

Innovation in the self-assembly  
beehive category!  
Slats integrated with the hive body walls.



Hive for easy  
self-assembly  
thanks to  
„dovetail” system.



- **VERSATILITY**
- **LONGEVITY**
- **CONVENIENCE**
- **VARIOUS CONFIGURATIONS**

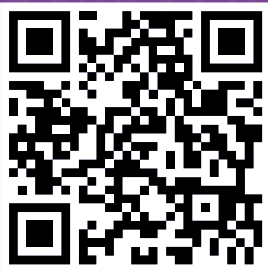

**SCAN  
THE CODE  
and watch  
the video!**

**NEW**

PAGE  
**166**

# Hives from the Multi-frame line DADANT



Available with a high or low roof

Two versions of the feeder: 7.5 L or 2 x 4.5 L

Configuration of the number of hive bodies

## CONVENIENT SHIPPING, EASY TRANSPORT AND COMPACT STORAGE

### CHOOSE YOUR COLOR:



**ORANGE**

**GREEN**

**WHITE**



Other colors from the offer available with order over 20 pcs.

# MULTI-FRAME 10 FRAME NEW LINE OF BEEHIVES

Thanks to its compatibility with various frames and standardized elements such as bottoms, feeders and roofs, the hive allows easy changes to the apiary layout.

The dovetail connection system ensures the stability and durability of the structure, while allowing for easy and quick installation without the need for special tools.

Integrated mounting rails in the hive bodies allow for quick assembly also fast assembly of the hive – even outdoor! Time savings and convenience of work are invaluable during the intense beekeeping season.

The connection of mounting rails to the hive body through a specially developed technological process ensures:

- 1. Longevity** – The solid integration of elements eliminates the risk of deformation or damage caused by intensive use.
- 2. Weather resistance** – Tight and durable connections protect the hive from moisture, UV radiation, and extreme temperatures.
- 3. Enhanced functionality** – The integrated design facilitates the handling of hive components and their maintenance.

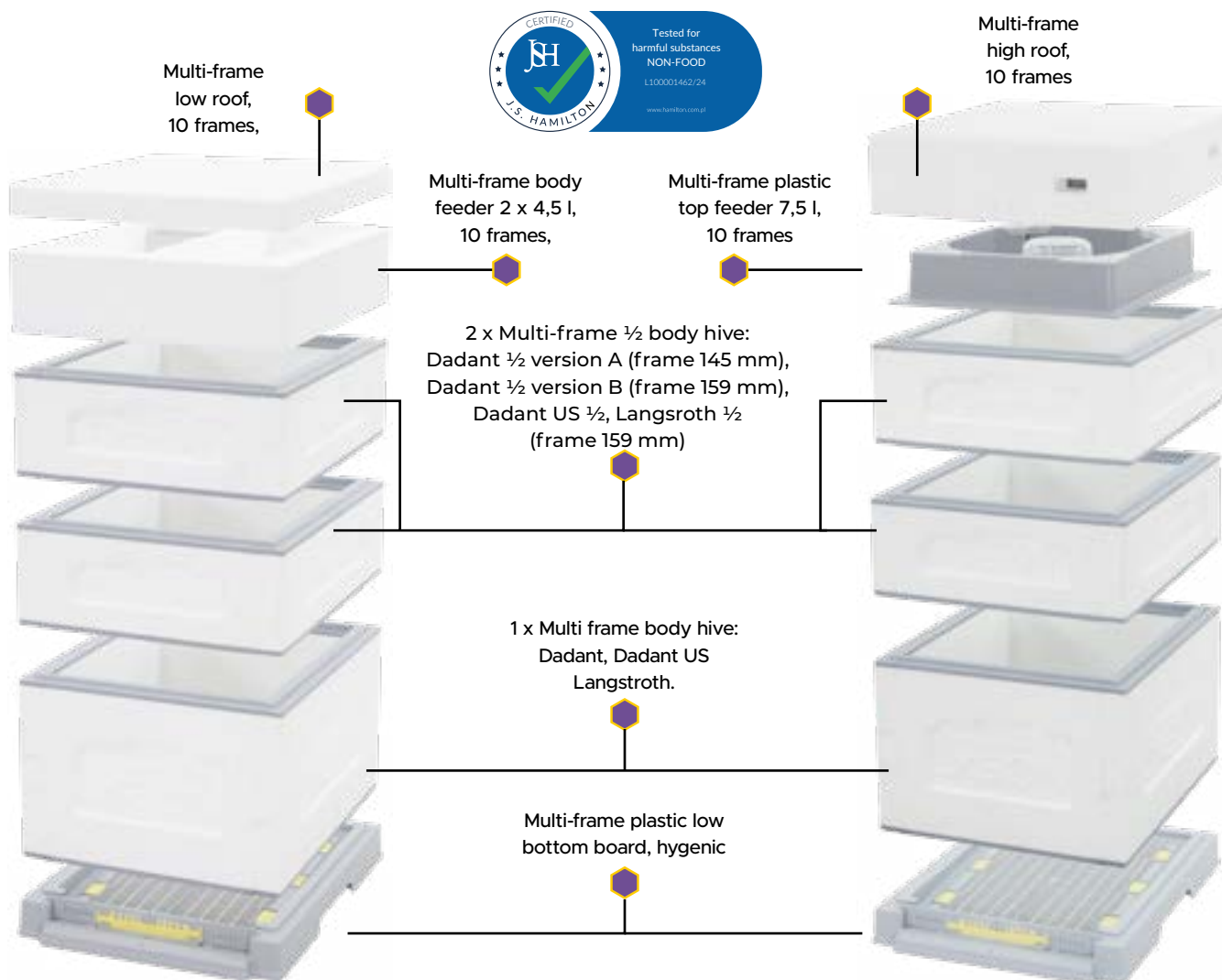

DADANT VERSION A, DADANT VERSION B, DADANT US BEEHIVE

AMERICAN LANGSTROTH BEEHIVE

# MULTI-FRAME 6 FRAME NEW LINE OF BEEHIVES

The Multi-frame American Langstroth 6-frame beehive is a high-quality, versatile solution for beekeepers who value flexibility and comfort of use.

The unpainted model, complete with a low roof, hive brood body and plastic hygienic, low bottom board, ensures optimal conditions for the development of the bee family and ease of running an apiary. The bottom board is compatible with Multi-frame American Langstroth and Multi-frame Dadant systems offering versatility and convenience.

Production based on laboratory-tested raw materials, which guarantees safety and durability.

The international certificate confirms high standards and top quality. Our offer includes the following color variants: not painted (white), orange, and green.



Multi-frame low roof, 6 frames



Multi-frame body feeder, 6 frames



Multi-frame, Dadant, Dadant US or American Langstroth hive body, 6 frames



Multi-frame plastic low bottom board, 6 frames, hygienic



## OPTIONAL ELEMENTS TO MULTI-FRAME BEEHIVES, 10 FRAMES



The dovetail connection system - assembly quick and tool-free



Integrated mounting rails in the hive bodies during steam production



Our offer includes the following color variants: not painted (white), orange and green.



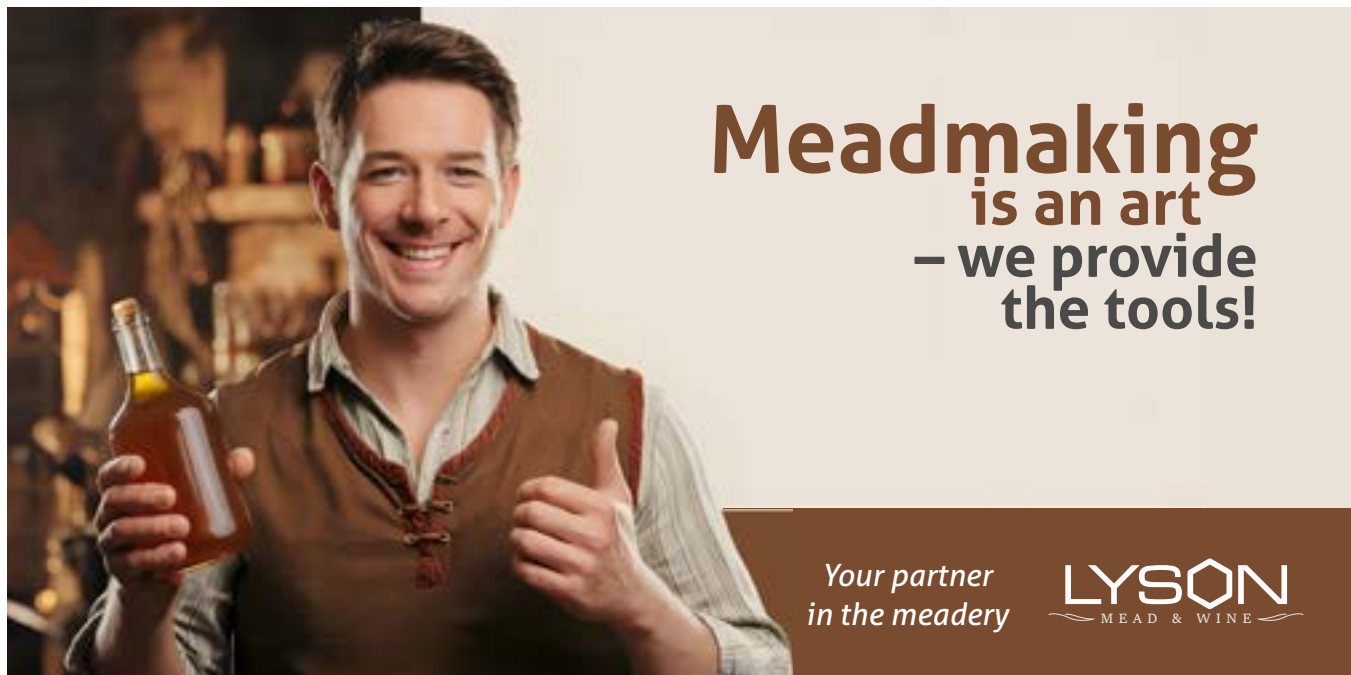

## LYSON MEAD & WINE TRADITION, INNOVATION, QUALITY

For over 30 years, LYSON has been providing high-quality stainless steel equipment for beekeepers worldwide. With our extensive experience and commitment to technological advancement, expanding into the mead and winemaking industry is a natural step forward. For many beekeepers, producing mead is a logical extension of their craft, and we are here to support them by delivering reliable and professional solutions.

Stainless steel fermentation equipment to meet your needs!

Are you looking for a robust and versatile solution? Count on our quality and experience!



ID	NAME
WM100_330	Fermentation tank 330 l, flat bottom
WM101_330N	Fermentation tank 330 l, conical bottom
WM102_660	Fermentation tank 660 l, flat bottom
WM103_660N	Fermentation tank 660 l, conical bottom
WM104	Pasteuriser
WM105_KW300	Brewing kettle
WM107_MCIP_AUTO	CIP washer - automatic

# NEW

# BASIC line

## HONEY EXTRACTORS 720-900mm RADIAL & CASSETTE

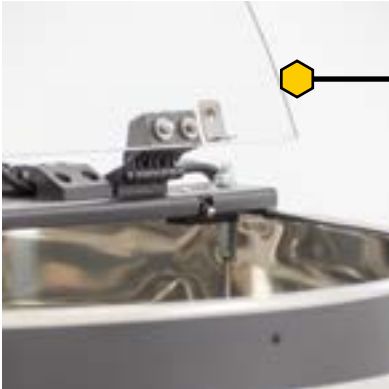

Safety lock - when the lid is opened, the basket is stopped



The controller has two manual programs and nine predefined automatic cycles. The controller also has one automatic program with the possibility of leading your own settings



The drum is made of stainless steel and the conical bottom facilitates honey drainage

Stainless steel valve mounted at the bottom



Bottom-mounted motor on a crossbar

Easy to assemble legs

# NEW IN OUR OFFER!

## CLASSIC SETTLING TANK

The latest CLASSIC settling tanks are tailored to meet the diverse needs of beekeepers, ensuring efficient and safe storage of honey at every stage of its production.

Available in capacities ranging from 30 to 300 litres, CLASSIC settling tanks are available with or without clamps and seals, allowing you to choose a range that meets your individual beekeeper's needs.

Made from high-quality stainless steel, they offer exceptional durability and resistance to damage and corrosion, making them ideal for long-term honey storage. The silicone gasket is a guarantee that the honey is protected against moisture absorption, as well as contamination from outside.



## SCAN QR CODE

and see all models online!

PAGE

124

**AUTOMATIC HONEY EXTRACTION  
LINES 40 AND 100 FRAME**



PAGE  
**96**

**LARGE ROTARY  
WAX MELTER**



PAGE  
**145**

W4807

**ROTARY STAND FOR BEE  
FRAMES, UNIVERSAL,  
Ø900 MM**



PAGE  
**104**

W20670

**WATER WAX MELTER, DUAL CHAMBER, WITH FRAME CLEANING FUNCTION**

PAGE  
**143**



W7054

**ROTARY WAX MELTER, INSULATED**

PAGE  
**146**



W4805\_O

**FREESTANDING CABINET FOR APIARY WORKSHOP, WITH DOUBLE DOOR, SOFT CLOSE, PREMIUM, 1200 MM**

PAGE  
**109**



W934\_P

**WAX MELTER - SOLAR, FOR 10-FRAMES**

PAGE  
**146**



W3250

**SET OF HANGERS (3 PCS.) FOR THE PRODUCTION OF DIPPED CANDLES WITH A WAX MELTING TANK**

PAGE  
**144**



W4510

**PROPOLIS EXTRACTION MACHINE**

PAGE  
**152**



W380

**STAINLESS STEEL SETTLING TANKS 500 KG - 1250 KG**

W857

PAGE  
**122**



**STAINLESS STEEL SYRUP MIXERS WITH HEATING JACKETS, 500 KG, 1000 KG**

PAGE  
**127**

W858MP



**SET OF CHESS SILICONE MOLDS**

PAGE  
**232**



**NEW EASTER SILICONE MOLDS**

PAGE  
**228**



**NEW SILICONE MOLDS**



# PLASTIC DADANT BEE FOUNDATION

Made of high-quality polyethylene approved for contact with food. Durable and safe alternative to traditional wax foundation. Thanks to its exceptional durability, it significantly improves work in the apiary, while positively affecting the health of bee colonies.



## ECONOMY IN THE APIARY - COST REDUCTION UP TO 30%



Thanks to its durability, the plastic bee foundation allows for:

- ✓ **faster spinning** without the risk of tearing the frames (possibility of spinning at approx. 30% higher speed).
- ✓ possibility of using frames at **high temperatures** or with **very high loads** – no risk of the comb collapsing
- ✓ **reducing the presence of pesticides**
- ✓ the possibility of closing the wax cycle in the apiary.



Dadant: 413x280 mm



Product is made of polyethylene (PE) approved for contact with food.



Tested as part of the EU project: "Healthy and innovative apiary" <https://krolewskie-miody.pl/grupa-operacyjna-zdrowa-i-innowacyjna-pasieka>



Cost optimization up to 30%. No annual frame assembling and wiring



Bee colony health improvement – bees raised in plastic frames show greater resistance to viruses.



Closing the wax cycle in the apiary, which eliminates the risk of contamination.



Allows frame use in extreme heat or during intense honey flow - without the risk of comb collapse



Possibility of washing, disinfecting, freezing. Resistant to wax moths.

ID	NAME
30622	Wooden frame for plastic foundation, Dadant (10 pcs.)
2003	Plastic foundation, Dadant (10 pcs.)
2004	Plastic foundation, Dadant (20 pcs.)
2005	Plastic foundation, Dadant (50 pcs.)

## HOT WATER WAX MELTER

W7053

PAGE  
**142**



## HONEY BOTTLER WITH BUILT-IN SCALE

W204006

PAGE  
**131**



## STAINLESS STEEL SETTLING TANK WITH HANDLES, ADDITIONAL DRAIN VALVE AND CONICAL SIEVE

PAGE  
**126**



## POLLEN CLEANER 230V - CLASSIC

W3213

PAGE  
**151**



## POLLEN CLEANER MINIMA

W3219



## VIBRATING POLLEN CLEANER 45 L

W3217

PAGE  
**152**



**BEEHIVE WITH PRINT, DADANT OPTIMA, PAINTED**

PAGE  
**156**



**NEW DADANT ROOF - CLASSIC**

PAGE  
**154**

W1015C



**EDUCATIONAL DADANT BEEHIVE + 12 FRAMES WITH TEACHING BOARDS**

PAGE  
**159**



**DADANT ROOF AND BOTTOM BOARD - PREMIUM**

PAGE  
**164**

W1015T



W102200T

**TROLLEYS FOR SETTLING TANKS/CREAMING MACHINES**

PAGE  
**119**



W6606\_L

# MINI CLASSIC HIVE DADANT

The mini CLASSIC hive is the ideal solution for beekeepers looking for a versatile and functional hive for rearing queens or wintering small colonies. Thanks to its innovative modular frames, it allows them to be combined and transferred to a full-size hive as half frames. Its robust construction and thoughtful solutions make it a hive of exceptional durability and practicality.



**NEW**

## ADVANTAGES:

- ◆ Four-sided roof
- ◆ Two-family feeder
- ◆ Functional body and bottom
- ◆ Modular frames



W13\_UC\_N

W13\_UC\_X

W14\_UC\_N

W14\_UC\_X



PAGE  
**182**

# BESTSELLERS



PAGE  
**42**

W2013



PAGE  
**56**

W2006000G



PAGE  
**121**

W2021GNF



PAGE  
**101**

W2096000Z

PAGE  
**117**

W20087\_Z



# BESTSELLERS

PAGE  
**160**



LU1008H\_B

PAGE  
**181**



W1044

PAGE  
**225**



F007

PAGE  
**132**



W204001Z

PAGE  
**143**



W4090

PAGE  
**206**



M6057S1

M6010

PAGE  
**219**

PAGE  
**209**

M6056

# 1. HONEY EXTRACTORS



Appliances bearing the CE mark (CE Marking) meet the requirements of EU directives concerning health and safety issues, and environmental protection. Manufacturer declares that products marked with CE complies with the essential requirements and other relevant provisions of EU directives.

# TANGENTIAL HONEY EXTRACTORS

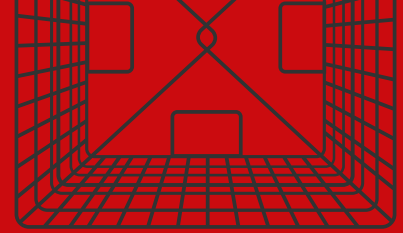
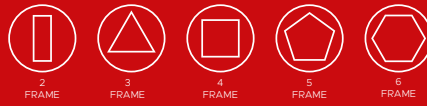

## CLASSIC line

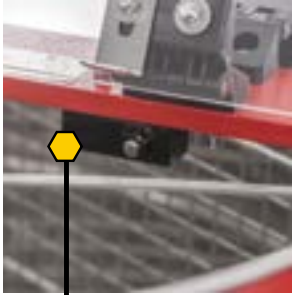

Safety lock - after opening the cover the basket is stopped

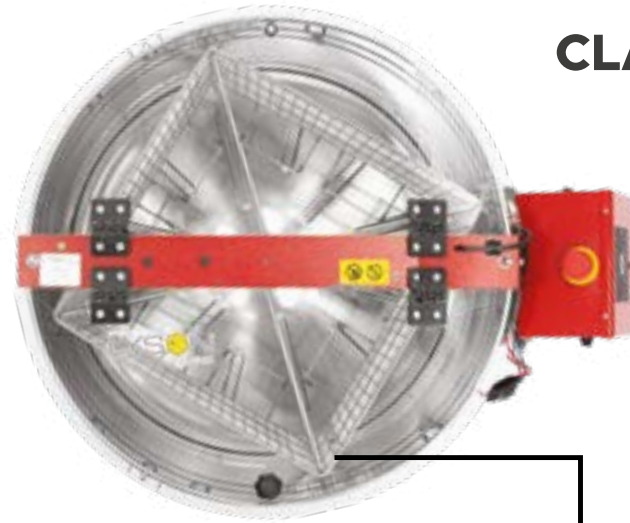

Drum and basket made of stainless steel



Baskets with smooth, polished welds - no risk of injury when inserting frames into the honey extractors



Controller - digital display and dual power supply 230V + 12V (110V and 12V option)



Sturdy construction - facilitating safe extraction (construction reinforced with a lower crossbar and upper band)



Conical shaped bottom - for easy draining of the honey



STAINLESS STEEL AISI316



STAINLESS ACID-RESISTANT STEEL AISI304



THE DEVICE COMPLIES WITH THE LEGAL REQUIREMENTS APPLICABLE IN THE EU



IMPORTANT INFORMATION

**BASIC**  
line

**MINIMA**  
line

**OPTIMA**  
line

<b>ID</b>	ZESTAW_BASIC or ZESTAW_MINIMA
<b>Drum diameter</b>	from Ø400 mm to Ø650 mm
<b>Drive system</b>	electric
<b>Power supply</b>	230V
<b>Motor</b>	18V/80W
<b>Controller mount</b>	top bar
<b>Circuit board</b>	MDD-1
<b>Controller</b>	potentiometer

<b>ID</b>	41240064
<b>Drum diameter</b>	from Ø500 mm to Ø650 mm
<b>Drive system</b>	electric, manual-electric
<b>Power supply</b>	12V/230V
<b>Motor</b>	24V/250W
<b>Controller mount</b>	top bar
<b>Circuit board</b>	SDD-2DP
<b>Controller</b>	digital

**CLASSIC**  
line

**PREMIUM**  
line

<b>ID</b>	41240079
<b>Drum diameter</b>	from Ø500 mm to Ø900 mm
<b>Drive system</b>	electric, manual-electric
<b>Power supply</b>	12V/230V
<b>Motor</b>	24V/250W
<b>Controller mount</b>	leg
<b>Circuit board</b>	SDD-2DP
<b>Controller</b>	digital

<b>ID</b>	41240051
<b>Drum diameter</b>	from Ø500 mm to Ø600 mm
<b>Drive system</b>	electric, manual-electric
<b>Power supply</b>	12V/230V
<b>Motor</b>	24V/350W
<b>Controller mount</b>	leg
<b>Circuit board</b>	SDD-3
<b>Controller</b>	digital

110V controllers available

# 2-FRAME



**BASIC**  
line

**W233BBN\_NP**



**BASIC**  
line

**W233BB**



**BASIC**  
line

**W233BBN**

ID	<b>W233BBN_NP</b>	<b>W233BB</b>	<b>W233BBN</b>
<b>Name</b>	Honey extractor 2-frame, manual drive	Honey extractor, 2-frame, manual drive	Honey extractor, 2-frame, manual drive, with legs

## TECHNICAL PARAMETERS

<b>Drum diameter</b>	Ø400 mm	Ø400 mm	Ø400 mm
<b>Frame type</b>	Universal	Universal	Universal
<b>Drive system</b>	Manual plastic drive	Manual	Manual
<b>Power supply</b>	-	-	-
<b>Controller</b>	-	-	-
<b>Motor</b>	-	-	-

## DRUM AND BASKET CONSTRUCTION

<b>Thickness</b>	0,6 mm	0,6 mm	0,6 mm
<b>Honey gate</b>	Plastic 6/4"	Plastic 6/4"	Plastic 6/4"
<b>Top bar</b>	Powder coated plate	Powder coated plate	Powder coated plate
<b>Cover</b>	4 mm acrylic glass	4 mm acrylic glass	4 mm acrylic glass
<b>Legs</b>	Short, powder coated	None	Short, powder coated
<b>Hinges</b>	None	None	None
<b>Mesh size</b>	20×40 mm	20×40 mm	20×40 mm
<b>Basket mount</b>	Polyamide sleeve	Polyamide sleeve	Polyamide sleeve
<b>Drum rim</b>	None	None	None
<b>Drum height</b>	610 mm	610 mm	610 mm

## ADDITIONAL INFORMATION

<b>Other</b>	For self-assembly (shipped in carton)	For self-assembly (shipped in carton)	For self-assembly (shipped in carton)
--------------	---------------------------------------	---------------------------------------	---------------------------------------



WARRANTY DETAILS,  
PAGE 254-255.

# 2-FRAME



**OPTIMA**  
line

**OPTIMA**  
line

**OPTIMA**  
line

ID	W2019M	W2019N	W2019_OM
Name	Honey extractor, 2-frame, manual drive	Honey extractor, 2-frame, manual drive, with legs	Honey extractor, 2-frame, manual drive, with sieve and settling tank (50 l)

## TECHNICAL PARAMETERS

Drum diameter	Ø400 mm	Ø400 mm	Ø400 mm
Frame type	Universal	Universal	Universal
Drive system	Manual	Manual	Manual
Power supply	-	-	-
Controller	-	-	-
Motor	-	-	-

## DRUM AND BASKET CONSTRUCTION

Thickness	0,6 mm	0,6 mm	0,6 mm
Honey gate	Stainless 6/4"	Stainless 6/4"	Stainless 6/4"
Top bar	Powder coated plate	Powder coated plate	Powder coated plate
Cover	4 mm acrylic glass	4 mm acrylic glass	4 mm acrylic glass
Legs	None	Short, powder coated	None
Hinges	None	None	None
Mesh size	20×40 mm	20×40 mm	20×40 mm
Basket mount	Polyamide sleeve	Polyamide sleeve	Polyamide sleeve
Drum rim	None	None	None
Drum height	610 mm	610 mm	Settling tank: 430 mm Total: 990 mm

## ADDITIONAL INFORMATION

Other	For self-assembly (shipped in carton)	For self-assembly (shipped in carton)	For self-assembly (shipped in carton)
-------	---------------------------------------	---------------------------------------	---------------------------------------



WARRANTY DETAILS,  
PAGE 254-255.

## 3-FRAME



**BASIC**  
line

**W234BBN\_NP**



**BASIC**  
line

**W234BBN**



**BASIC**  
line

**W2029BB**



**MINIMA**  
line

**W2029BV**

ID	<b>W234BBN_NP</b>	<b>W234BBN</b>	<b>W2029BB</b>	<b>W2029BV</b>
<b>Name</b>	Honey extractor, 3-frame, manual drive	Honey extractor, 3-frame, manual drive	Honey extractor, 3-frame, manual drive	Honey extractor, 3-frame, manual drive

#### TECHNICAL PARAMETERS

<b>Drum diameter</b>	Ø400 mm	Ø400 mm	Ø500 mm	Ø500 mm
<b>Frame type</b>	Langstroth, Zander, Deutsch Normal	Langstroth, Zander, Deutsch Normal	Universal	Universal
<b>Drive system</b>	Manual plastic drive	Manual	Manual	Manual
<b>Power supply</b>	-	-	-	-
<b>Controller</b>	-	-	-	-
<b>Motor</b>	-	-	-	-

#### DRUM AND BASKET CONSTRUCTION

<b>Thickness</b>	0,6 mm	0,6 mm	drum 0,6 mm bottom 0,8 mm	drum 0,6 mm bottom 0,8 mm
<b>Honey gate</b>	Plastic 6/4"	Plastic 6/4"	Plastic 6/4"	Stainless 6/4"
<b>Top bar</b>	Powder coated plate	Powder coated plate	Flat bar 10 mm powder coated	Flat bar 10 mm powder coated
<b>Cover</b>	4 mm acrylic glass	4 mm acrylic glass	4 mm acrylic glass	4 mm acrylic glass
<b>Legs</b>	Short, powder coated	Short, powder coated	Short, powder coated	Short, powder coated
<b>Hinges</b>	None	None	Plastic 4 pcs.	Plastic 4 pcs.
<b>Mesh size</b>	20×20 mm	20×20 mm	20×20 mm	20×20 mm
<b>Basket mount</b>	Polyamide sleeve	Polyamide sleeve	Polyamide sleeve	Polyamide sleeve
<b>Drum rim</b>	None	None	None	None
<b>Drum height</b>	610 mm	610 mm	610 mm	610 mm

#### ADDITIONAL INFORMATION

<b>Other</b>	For self-assembly (shipped in carton)	For self-assembly (shipped in carton)	For self-assembly (shipped in carton)	For self-assembly (shipped in carton)
--------------	--	--	--	--



WARRANTY DETAILS,  
PAGE 254-255.

# 3-FRAME



**OPTIMA**  
line

**W2029M**



**OPTIMA**  
line

**W2029\_OM**



**CLASSIC**  
line

**W2002**



**PREMIUM**  
line

**W2002P**

ID	<b>W2029M</b>	<b>W2029_OM</b>	<b>W2002</b>	<b>W2002P</b>
<b>Name</b>	Honey extractor, 3-frame, manual drive	Honey extractor, 3-frame, manual drive, with sieve and settling tank 80 l	Honey extractor, 3-frame, manual drive	Honey extractor, 3-frame, manual drive

## TECHNICAL PARAMETERS

<b>Drum diameter</b>	Ø500 mm	Ø500 mm	Ø500 mm	Ø500 mm
<b>Frame type</b>	Universal	Universal	Universal	Universal
<b>Drive system</b>	Manual	Manual	Manual	Manual
<b>Power supply</b>	-	-	-	-
<b>Controller</b>	-	-	-	-
<b>Motor</b>	-	-	-	-

## DRUM AND BASKET CONSTRUCTION

<b>Thickness</b>	drum 0,6 mm bottom 0,8 mm	drum 0,6 mm bottom 0,8 mm	drum 0,6 mm bottom 0,8 mm	0,8 mm
<b>Honey gate</b>	Stainless 6/4"	Stainless 6/4"	Stainless 6/4"	Stainless 6/4"
<b>Top bar</b>	Flat bar 10 mm powder coated	Flat bar 10 mm powder coated	Flat bar 10 mm powder coated	Flat bar 10 mm stainless
<b>Cover</b>	4 mm acrylic glass	4 mm acrylic glass	4 mm acrylic glass	5 mm acrylic glass
<b>Legs</b>	Short, powder coated	None	Long, powder coated	Long stainless
<b>Hinges</b>	Plastic 4 pcs.	Plastic 4 pcs.	Plastic 4 pcs.	Stainless 4 pcs.
<b>Mesh size</b>	20×20 mm	20×20 mm	20×20 mm	10×10 mm
<b>Basket mount</b>	Polyamide sleeve	Polyamide sleeve	Polyamide sleeve	Polyamide sleeve
<b>Drum rim</b>	None	None	Powder coated	Stainless
<b>Drum height</b>	610 mm	Settling tank: 430 mm Total: 990 mm	610 mm	610 mm

## ADDITIONAL INFORMATION

<b>Other</b>	For self-assembly (shipped in carton)	For self-assembly (shipped in carton)	Shipped on pallet (packed in carton)	Shipped on pallet (packed in carton)
--------------	---------------------------------------	---------------------------------------	--------------------------------------	--------------------------------------



WARRANTY DETAILS,  
PAGE 254-255.

## 3-FRAME

**BASIC**  
line

**W2030BB**

**MINIMA**  
line

**W2030BV**

**OPTIMA**  
line

**W2030**

**CLASSIC**  
line

**W2012**

**PREMIUM**  
line

**W2012P**

ID	<b>W2030BB</b>	<b>W2030BV</b>	<b>W2030</b>	<b>W2012</b>	<b>W2012P</b>
<b>Name</b>	Honey extractor, 3-frame, electric drive	Honey extractor, 3-frame, electric drive	Honey extractor, 3-frame, electric drive	Honey extractor, 3-frame, electric drive	Honey extractor, 3-frame, electric drive

**TECHNICAL PARAMETERS**

<b>Drum diameter</b>	Ø500 mm	Ø500 mm	Ø500 mm	Ø500 mm	Ø500 mm
<b>Frame type</b>	Universal	Universal	Universal	Universal	Universal
<b>Drive system</b>	Electric	Electric	Electric	Electric	Electric
<b>Power supply</b>	230V	230V	12V/230V	12V/230V	12V/230V
<b>Controller</b>	MDD-01*	MDD-01*	CDD*	SDD-2DP*	SDD-3
<b>Motor</b>	18V/80W	18V/80W	24V/250W	24V/250W	24V/350W

**DRUM AND BASKET CONSTRUCTION**

<b>Thickness</b>	drum 0,6 mm bottom 0,8 mm	drum 0,6 mm bottom 0,8 mm	drum 0,6 mm bottom 0,8 mm	drum 0,6 mm bottom 0,8 mm	0,8 mm
<b>Honey gate</b>	Plastic 6/4"	Stainless 6/4"	Stainless 6/4"	Stainless 6/4"	Stainless 6/4"
<b>Top bar</b>	Flat bar 10 mm powder coated	Flat bar 10 mm powder coated	Flat bar 10 mm powder coated	Flat bar 10 mm powder coated	Flat bar 10 mm stainless
<b>Cover</b>	4 mm acrylic glass	4 mm acrylic glass	4 mm acrylic glass	4 mm acrylic glass	5 mm acrylic glass
<b>Legs</b>	Short, powder coated	Short, powder coated	Short, powder coated	Long, powder coated	Long, stainless
<b>Hinges</b>	Plastic 4 pcs.	Plastic 4 pcs.	Plastic 4 pcs.	Plastic 4 pcs.	Stainless 4 pcs.
<b>Mesh size</b>	20×20 mm	20×20 mm	20×20 mm	20×20 mm	10×10 mm
<b>Basket mount</b>	Polyamide sleeve	Polyamide sleeve	Drum mounted Bearing	Frame mounted Bearing	Frame mounted Bearing
<b>Drum rim</b>	None	None	None	Powder coated	Stainless
<b>Drum height</b>	610 mm	610 mm	610 mm	610 mm	610 mm

**ADDITIONAL INFORMATION**

<b>Other</b>	For self-assembly (shipped in carton)	For self-assembly (Shipped in carton)	For self-assembly (Shipped in carton)	Shipped on pallet (Packed in carton)	Shipped on pallet (Packed in carton)
--------------	--	--	--	---	---

\* Possibility to install the left/right directional controller in electric extractors - additional fees apply



WARRANTY DETAILS,  
PAGE 254-255.

# 3-FRAME



**OPTIMA**  
line

**W2032**



**CLASSIC**  
line

**W20120**



**PREMIUM**  
line

**W20120P**

ID	<b>W2032</b>	<b>W20120</b>	<b>W20120P</b>
<b>Name</b>	Honey extractor, 3-frame, manual+electric	Honey extractor, 3-frame, manual+electric	Honey extractor, 3-frame, manual+electric

## TECHNICAL PARAMETERS

<b>Drum diameter</b>	Ø500 mm	Ø500 mm	Ø500 mm
<b>Frame type</b>	Universal	Universal	Universal
<b>Drive system</b>	Manual + electric	Manual + electric	Manual + electric
<b>Power supply</b>	12V/230V	12V/230V	12V/230V
<b>Controller</b>	CDD	SDD-2DP	SDD-3
<b>Motor</b>	24V/250W	24V/250W	24V/350W

## DRUM AND BASKET CONSTRUCTION

<b>Thickness</b>	drum 0,6 mm bottom 0,8 mm	drum 0,6 mm bottom 0,8 mm	0,8 mm
<b>Honey gate</b>	Stainless 6/4"	Stainless 6/4"	Stainless 6/4"
<b>Top bar</b>	Flat bar 10 mm powder coated	Flat bar 10 mm powder coated	Flat bar 10 mm stainless
<b>Cover</b>	4 mm acrylic glass	4 mm acrylic glass	5 mm acrylic glass
<b>Legs</b>	Short, powder coated	Long, powder coated	Long, stainless
<b>Hinges</b>	Plastic 4 pcs.	Plastic 4 pcs.	Stainless 4 pcs.
<b>Mesh size</b>	20×20 mm	20×20 mm	10×10 mm
<b>Basket mount</b>	Drum mounted bearing	Frame mounted bearing	Frame mounted bearing
<b>Drum rim</b>	None	Powder coated	Stainless
<b>Drum height</b>	610 mm	610 mm	610 mm

## ADDITIONAL INFORMATION

<b>Other</b>	For self-assembly (shipped in carton)	Shipped on pallet (Packed in carton)	Shipped on pallet (Packed in carton)
--------------	--	---	---



WARRANTY DETAILS,  
PAGE 254-255.

## 4-FRAME



	<b>BASIC</b> line	<b>BASIC</b> line	<b>MINIMA</b> line	<b>MINIMA</b> line	<b>MINIMA</b> line
<b>ID</b>	<b>W2026BB</b>	<b>W2027BB</b>	<b>W2026BV</b>	<b>W2027BV</b>	<b>W2027BV_NEW</b>
<b>Name</b>	Honey extractor Ø500mm, 4-frame, manual drive	Honey extractor Ø600mm, 4-frame, manual drive	Honey extractor Ø500mm, 4-frame, manual drive	Honey extractor Ø600mm, 4-frame, manual drive	Honey extractor Ø600mm, 4-frame, manual drive, without axle
<b>TECHNICAL PARAMETERS</b>					
<b>Drum diameter</b>	Ø500 mm	Ø600 mm	Ø500 mm	Ø600 mm	Ø600 mm
<b>Frame type</b>	Langstroth, Zander, Deutsch Normal	Universal	Langstroth, Zander, Deutsch Normal	Universal	Universal
<b>Drive system</b>	Manual	Manual	Manual	Manual	Manual
<b>Power supply</b>	-	-	-	-	-
<b>Controller</b>	-	-	-	-	-
<b>Motor</b>	-	-	-	-	-
<b>DRUM AND BASKET CONSTRUCTION</b>					
<b>Thickness</b>	drum 0,6 mm bottom 0,8 mm	drum 0,6 mm bottom 0,8 mm	drum 0,6 mm bottom 0,8 mm	drum 0,6 mm bottom 0,8 mm	drum 0,6 mm bottom 0,8 mm
<b>Honey gate</b>	Plastic 6/4"	Plastic 6/4"	Stainless 6/4"	Stainless 6/4"	Stainless 6/4"
<b>Top bar</b>	Flat bar 10 mm powder coated	Flat bar 10 mm powder coated	Flat bar 10 mm powder coated	Flat bar 10 mm powder coated	Flat bar 10 mm powder coated
<b>Cover</b>	4 mm acrylic glass	4 mm acrylic glass	4 mm acrylic glass	4 mm acrylic glass	4 mm acrylic glass
<b>Legs</b>	Short, powder coated	Short, powder coated	Short, powder coated	Short, powder coated	Short, powder coated
<b>Hinges</b>	Plastic 4 pcs.	Plastic 4 pcs.	Plastic 4 pcs.	Plastic 4 pcs.	Plastic 4 pcs.
<b>Mesh size</b>	20×20 mm	20×20 mm	20×20 mm	20×20 mm	20×20 mm
<b>Basket mount</b>	Polyamide sleeve	Polyamide sleeve	Polyamide sleeve	Polyamide sleeve	Polyamide sleeve
<b>Drum rim</b>	None	None	None	None	None
<b>Drum height</b>	610 mm	610 mm	610 mm	610 mm	735 mm
<b>ADDITIONAL INFORMATION</b>					
<b>Other</b>	For self-assembly (shipped in carton)	For self-assembly (shipped in carton)	For self-assembly (Shipped in carton)	For self-assembly (Shipped in carton)	For self-assembly (Shipped in carton)



WARRANTY DETAILS,  
PAGE 254-255.

## 4-FRAME



	<b>OPTIMA</b> line	<b>OPTIMA</b> line	<b>CLASSIC</b> line	<b>CLASSIC</b> line	<b>PREMIUM</b> line
<b>ID</b>	<b>W2026</b>	<b>W2027M</b>	<b>W2003</b>	<b>W2013A</b>	<b>W2003P</b>
<b>Name</b>	Honey extractor Ø500mm, 4-frame, manual drive	Honey extractor Ø600mm, 4-frame, manual drive	Honey extractor Ø600mm, 4-frame, manual drive	Honey extractor Ø500mm, 4-frame, manual drive	Honey extractor Ø600mm, 4-frame, manual drive
<b>TECHNICAL PARAMETERS</b>					
<b>Drum diameter</b>	Ø500 mm	Ø600 mm	Ø600 mm	Ø500 mm	Ø600 mm
<b>Frame type</b>	Langstroth, Zander, Deutsch Normal	Universal	Universal	Langstroth, Zander, Deutsch Normal	Universal
<b>Drive system</b>	Manual	Manual	Manual	Manual	Manual
<b>Power supply</b>	-	-	-	-	-
<b>Controller</b>	-	-	-	-	-
<b>Motor</b>	-	-	-	-	-
<b>DRUM AND BASKET CONSTRUCTION</b>					
<b>Thickness</b>	drum 0,6 mm bottom 0,8 mm	drum 0,6 mm bottom 0,8 mm	drum 0,6 mm bottom 0,8 mm	drum 0,6 mm bottom 0,8 mm	0,8 mm
<b>Honey gate</b>	Stainless 6/4"	Stainless 6/4"	Stainless 6/4"	Stainless 6/4"	Stainless 6/4"
<b>Top bar</b>	Flat bar 10 mm powder coated	Flat bar 10 mm powder coated	Flat bar 10 mm powder coated	Flat bar 10 mm powder coated	Flat bar 10 mm stainless
<b>Cover</b>	4 mm acrylic glass	4 mm acrylic glass	4 mm acrylic glass	4 mm acrylic glass	5 mm acrylic glass
<b>Legs</b>	Short, powder coated	Short, powder coated	Long, powder coated	Long, powder coated	Long, stainless
<b>Hinges</b>	Plastic 4 pcs.	Plastic 4 pcs.	Plastic 4 pcs.	Plastic 4 pcs.	Stainless 4 pcs.
<b>Mesh size</b>	20x20 mm	20x20 mm	20x20 mm	20x20 mm	10x10 mm
<b>Basket mount</b>	Polyamide sleeve	Polyamide sleeve	Polyamide sleeve	Polyamide sleeve	Polyamide sleeve
<b>Drum rim</b>	None	None	Powder coated	Powder coated	Stainless
<b>Drum height</b>	610 mm	610 mm	610 mm	610 mm	610 mm
<b>ADDITIONAL INFORMATION</b>					
<b>Other</b>	For self-assembly (Shipped in carton)	For self-assembly (Shipped in carton)	Shipped on pallet (packed in carton)	Shipped on pallet (packed in carton)	Shipped on pallet (packed in carton)



WARRANTY DETAILS,  
PAGE 254-255.

## 4-FRAME



	<b>BASIC</b> line	<b>BASIC</b> line	<b>MINIMA</b> line	<b>MINIMA</b> line	<b>MINIMA</b> line
<b>ID</b>	<b>W2033BB</b>	<b>W224BB</b>	<b>W2033BV</b>	<b>W224BV</b>	<b>W224BV_NEW</b>
<b>Name</b>	Honey extractor Ø500mm, 4-frame, electric drive	Honey extractor Ø600mm, 4-frame, electric drive	Honey extractor Ø500mm, 4-frame, electric drive	Honey extractor Ø600mm, 4-frame, electric drive	Honey extractor Ø600mm, 4-frame, electric drive, without axle
TECHNICAL PARAMETERS					
<b>Drum diameter</b>	Ø500 mm	Ø600 mm	Ø500 mm	Ø600 mm	Ø600 mm
<b>Frame type</b>	Langstroth, Zander, Deutsch Normal	Universal	Langstroth, Zander, Deutsch Normal	Universal	Universal
<b>Drive system</b>	Electric	Electric	Electric	Electric	Electric
<b>Power supply</b>	230V	230V	230V	230V	230V
<b>Controller</b>	MDD-01*	MDD-01*	MDD-01*	MDD-01*	MDD-01*
<b>Motor</b>	18V/80W	18V/80W	18V/80W	18V/80W	18V/80W
DRUM AND BASKET CONSTRUCTION					
<b>Thickness</b>	drum 0,6 mm bottom 0,8 mm	drum 0,6 mm bottom 0,8 mm	drum 0,6 mm bottom 0,8 mm	drum 0,6 mm bottom 0,8 mm	drum 0,6 mm bottom 0,8 mm
<b>Honey gate</b>	Plastic 6/4"	Plastic 6/4"	Stainless 6/4"	Stainless 6/4"	Stainless 6/4"
<b>Top bar</b>	Flat bar 10 mm po- wder coated	Flat bar 10 mm po- wder coated	Flat bar 10 mm powder coated	Flat bar 10 mm powder coated	Flat bar 10 mm powder coated
<b>Cover</b>	4 mm acrylic glass	4 mm acrylic glass	4 mm acrylic glass	4 mm acrylic glass	4 mm acrylic glass
<b>Legs</b>	Short, powder coated	Short, powder coated	Short, powder coated	Short, powder coated	Short, powder coated
<b>Hinges</b>	Plastic 4 pcs.	Plastic 4 pcs.	Plastic 4 pcs.	Plastic 4 pcs.	Plastic 4 pcs.
<b>Mesh size</b>	20×20 mm	20×20 mm	20×20 mm	20×20 mm	20×20 mm
<b>Basket mount</b>	Polyamide sleeve	Polyamide sleeve	Polyamide sleeve	Polyamide sleeve	Polyamide sleeve
<b>Drum rim</b>	None	None	None	None	None
<b>Drum height</b>	610 mm	610 mm	610 mm	610 mm	735 mm
ADDITIONAL INFORMATION					
<b>Other</b>	For self-assembly (shipped in carton)	For self-assembly (shipped in carton)	For self-assembly (Shipped in carton)	For self-assembly (Shipped in carton)	For self-assembly (Shipped in carton)

\* Possibility to install the left/right directional controller in electric extractors - additional fees apply



WARRANTY DETAILS,  
PAGE 254-255.

## 4-FRAME



	<b>OPTIMA</b> line	<b>OPTIMA</b> line	<b>CLASSIC</b> line	<b>CLASSIC</b> line	<b>PREMIUM</b> line
<b>ID</b>	<b>W2039</b>	<b>W225MS</b>	<b>W20130</b>	<b>W2013B</b>	<b>W20130P</b>
<b>Name</b>	Honey extractor Ø500mm, 4-frame, manual+electric drive	Honey extractor Ø600mm, 4-frame, manual+electric drive	Honey extractor Ø600mm, 4-frame, manual+electric drive	Honey extractor Ø500mm, 4-frame, manual+electric drive	Honey extractor Ø600mm, 4-frame, manual+electric drive
<b>TECHNICAL PARAMETERS</b>					
<b>Drum diameter</b>	Ø500 mm	Ø600 mm	Ø600 mm	Ø500 mm	Ø600 mm
<b>Frame type</b>	Langstroth, Zander, Deutsch Normal	Universal	Universal	Langstroth, Zander, Deutsch Normal	Universal
<b>Drive system</b>	Manual + electric	Manual + electric	Manual + electric	Manual + electric	Manual + electric
<b>Power supply</b>	12V/230V	12V/230V	12V/230V	12V/230V	12V/230V
<b>Controller</b>	CDD	CDD	SDD-2DP	SDD-2DP	SDD-3
<b>Motor</b>	24V/250W	24V/250W	24V/250W	24V/250W	24V/350W
<b>DRUM AND BASKET CONSTRUCTION</b>					
<b>Thickness</b>	drum 0,6 mm bottom 0,8 mm	drum 0,6 mm bottom 0,8 mm	drum 0,6 mm bottom 0,8 mm	drum 0,6 mm bottom 0,8 mm	0,8 mm
<b>Honey gate</b>	Stainless 6/4"	Stainless 6/4"	Stainless 6/4"	Stainless 6/4"	Stainless 6/4"
<b>Top bar</b>	Flat bar 10 mm powder coated	Flat bar 10 mm powder coated	Flat bar 10 mm powder coated	Flat bar 10 mm powder coated	Flat bar 10 mm stainless
<b>Cover</b>	4 mm acrylic glass	4 mm acrylic glass	4 mm acrylic glass	4 mm acrylic glass	5 mm acrylic glass
<b>Legs</b>	Short, powder coated	Short, powder coated	Long, powder coated	Long, powder coated	Long stainless
<b>Hinges</b>	Plastic 4 pcs.	Plastic 4 pcs.	Plastic 4 pcs.	Plastic 4 pcs.	Stainless 4 pcs.
<b>Mesh size</b>	20×20 mm	20×20 mm	20×20 mm	20×20 mm	10×10 mm
<b>Basket mount</b>	Drum mounted bearing	Drum mounted bearing	Frame mounted bearing	Frame mounted bearing	Frame mounted bearing
<b>Drum rim</b>	None	None	Powder coated	Powder coated	Stainless
<b>Drum height</b>	610 mm	610 mm	610 mm	610 mm	610 mm
<b>ADDITIONAL INFORMATION</b>					
<b>Other</b>	For self-assembly (shipped in carton)	For self-assembly (shipped in carton)	Shipped on pallet (packed in carton)	Shipped on pallet (packed in carton)	Shipped on pallet (packed in carton)



WARRANTY DETAILS,  
PAGE 254-255.

## 4-FRAME



	<b>OPTIMA</b> line	<b>CLASSIC</b> line	<b>CLASSIC</b> line	<b>PREMIUM</b> line
<b>ID</b>	<b>W224MS</b>	<b>W2013</b>	<b>W2013C</b>	<b>W2013P</b>
<b>Name</b>	Honey extractor Ø600mm, 4-frame, electric drive	Honey extractor Ø600mm, 4-frame, electric drive	Honey extractor Ø500mm, 4-frame, electric drive	Honey extractor Ø600mm, 4-frame, electric drive
TECHNICAL PARAMETERS				
<b>Drum diameter</b>	Ø600 mm	Ø600 mm	Ø500 mm	Ø600 mm
<b>Frame type</b>	Universal	Universal	Langstroth, Zander, Deutsch Normal	Universal
<b>Drive system</b>	Electric	Electric	Electric	Electric
<b>Power supply</b>	12V/230V	12V/230V	12V/230V	12V/230V
<b>Controller</b>	CDD*	SDD-2DP*	SDD-2DP*	SDD-3
<b>Motor</b>	24V/250W	24V/250W	24V/250W	24V/350W
DRUM AND BASKET CONSTRUCTION				
<b>Thickness</b>	drum 0,6 mm bottom 0,8 mm	drum 0,6 mm bottom 0,8 mm	drum 0,6 mm bottom 0,8 mm	0,8 mm
<b>Honey gate</b>	Stainless 6/4"	Stainless 6/4"	Stainless 6/4"	Stainless 6/4"
<b>Top bar</b>	Flat bar 10 mm Powder coated	Flat bar 10 mm Powder coated	Flat bar 10 mm Powder coated	Flat bar 10 mm Stainless
<b>Cover</b>	4 mm acrylic glass	4 mm acrylic glass	4 mm acrylic glass	5 mm acrylic glass
<b>Legs</b>	Short, powder coated	Long, powder coated	Long, powder coated	Long, stainless
<b>Hinges</b>	Plastic 4 pcs.	Plastic 4 pcs.	Plastic 4 pcs.	Stainless 4 pcs.
<b>Mesh size</b>	20×20 mm	20×20 mm	20×20 mm	10×10 mm
<b>Basket mount</b>	Drum mounted bearing	Frame mounted bearing	Frame mounted bearing	Frame mounted bearing
<b>Drum rim</b>	None	Powder coated	Powder coated	Stainless
<b>Drum height</b>	610 mm	610 mm	610 mm	610 mm
ADDITIONAL INFORMATION				
<b>Other</b>	For self-assembly (Shipped in carton)	Shipped on pallet (packed in carton)	Shipped on pallet (packed in carton)	Shipped on pallet (packed in carton)

\* Possibility to install the left/right directional controller - additional fees apply



WARRANTY DETAILS,  
PAGE 254-255.

# 5-FRAME

**CLASSIC**  
line

W2004

**CLASSIC**  
line

W2014

**CLASSIC**  
line

W20140

ID	W2004	W2014	W20140
Name	Honey extractor Ø600mm, 5-frame, manual drive	Honey extractor Ø600mm, 5-frame, electric drive	Honey extractor Ø600mm,5-frame, manual+electric drive

**TECHNICAL PARAMETERS**

Drum diameter	Ø600 mm	Ø600 mm	Ø600 mm
Frame type	Langstroth, Zander, Deutsch Normal	Langstroth, Zander, Deutsch Normal	Langstroth, Zander, Deutsch Normal
Drive system	Manual	Electric	Manual + electric
Power supply	—	12V/230V	12V/230V
Controller	—	SDD-2DP*	SDD-2DP
Motor	—	24V/250W	24V/250W

**DRUM AND BASKET CONSTRUCTION**

Thickness	drum 0,6 mm bottom 0,8 mm	drum 0,6 mm bottom 0,8 mm	drum 0,6 mm bottom 0,8 mm
Honey gate	Stainless 6/4"	Stainless 6/4"	Stainless 6/4"
Top bar	Flat bar 10 mm powder coated	Flat bar 10 mm powder coated	Flat bar 10 mm powder coated
Cover	4 mm acrylic glass	4 mm acrylic glass	4 mm acrylic glass
Legs	Long, powder coated	Long, powder coated	Long, powder coated
Hinges	Plastic 4 pcs.	Plastic 4 pcs.	Plastic 4 pcs.
Mesh size	20×20 mm	20×20 mm	20×20 mm
Basket mount	Polyamide sleeve	Polyamide sleeve	Polyamide sleeve
Drum rim	Powder coated	Powder coated	Powder coated
Drum height	610 mm	610 mm	610 mm

**ADDITIONAL INFORMATION**

Other	Shipped on pallet (Packed in carton)	Shipped on pallet (Packed in carton)	Shipped on pallet (Packed in carton)
-------	---	---	---

\* Possibility to install the left/right directional controller in electric extractors - additional fees apply



WARRANTY DETAILS,  
PAGE 254-255.

# 6-FRAME



**OPTIMA**  
line

**W229MS**



**OPTIMA**  
line

**W226MS**



**OPTIMA**  
line

**W227MS**

ID	<b>W229MS</b>	<b>W226MS</b>	<b>W227MS</b>
<b>Name</b>	Honey extractor Ø650mm, 6-frame, manual drive	Honey extractor Ø650mm, 6-frame, electric drive	Honey extractor Ø650mm, 6-frame, manual+electric drive

## TECHNICAL PARAMETERS

<b>Drum diameter</b>	Ø650 mm	Ø650 mm	Ø650 mm
<b>Frame type</b>	Langstroth, Zander, Deutsch Normal	Langstroth, Zander, Deutsch Normal	Langstroth, Zander, Deutsch Normal
<b>Drive system</b>	Manual	Electric	Manual + electric
<b>Power supply</b>	—	12V/230V	12V/230V
<b>Controller</b>	—	CDD*	CDD
<b>Motor</b>	—	24V/250W	24V/250W

## DRUM AND BASKET CONSTRUCTION

<b>Thickness</b>	drum 0,6 mm bottom 0,8 mm	drum 0,6 mm bottom 0,8 mm	drum 0,6 mm bottom 0,8 mm
<b>Honey gate</b>	Stainless 6/4"	Stainless 6/4"	Stainless 6/4"
<b>Top bar</b>	Flat bar 10 mm powder coated	Flat bar 10 mm powder coated	Flat bar 10 mm powder coated
<b>Cover</b>	4 mm acrylic glass	4 mm acrylic glass	4 mm acrylic glass
<b>Legs</b>	Short, powder coated	Short, powder coated	Short, powder coated
<b>Hinges</b>	Plastic 4 pcs.	Plastic 4 pcs.	Plastic 4 pcs.
<b>Mesh size</b>	20×20 mm	20×20 mm	20×20 mm
<b>Basket mount</b>	Polyamide sleeve	Drum mounted bearing	Drum mounted bearing
<b>Drum rim</b>	None	None	None
<b>Drum height</b>	610 mm	610 mm	610 mm

## ADDITIONAL INFORMATION

<b>Other</b>	For self-assembly (shipped in carton)	For self-assembly (shipped in carton)	For self-assembly (shipped in carton)
--------------	--	--	--

\* Possibility to install the left/right directional controller in electric extractors - additional fees apply



WARRANTY DETAILS,  
PAGE 254-255.

# RADIAL HONEY EXTRACTORS



## PREMIUM line

Beam, rim, legs, crossbar, hinges are made of stainless steel.

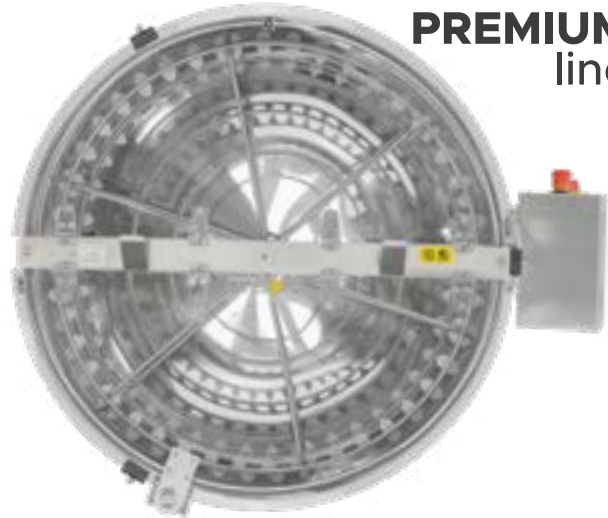

Drum height from 730 mm for honey extractors 720 mm to 1200 mm, made of acid-resistant stainless steel with a thickness of 0.8 mm, with a conical bottom.

Electromagnetic interlock - prevents opening of the extractor during operation



Modern controller with 7 fully programmable automatic cycles, one preset and two manual. Large display, controller works with Mitsubishi vector inverter.



It is entirely made of acid-resistant stainless steel bars. The rims of the basket are equipped with laser-cut mounts that prevent the frames from falling out during spinning. The basket is additionally bearing-mounted in two castings - upper and lower.



Stainless steel valve mounted at the bottom

The drive consists of a high-performance gearbox and motor from the THF eco-line series



STAINLESS STEEL AISI316



STAINLESS ACID-RESISTANT STEEL AISI304



THE DEVICE COMPLIES WITH THE LEGAL REQUIREMENTS APPLICABLE IN THE EU



IMPORTANT INFORMATION



	<b>BASIC</b> line	<b>BASIC MINIMA</b> line	<b>MINIMA</b> line	<b>OPTIMA</b> line
<b>ID</b>	41240186	ZESTAW_BASIC OR ZESTAW_MINIMA	41240152	<b>ID</b> 41240064
<b>Drum diameter</b>	from Ø720 mm to Ø900 mm	from Ø500 mm to Ø650 mm	from Ø720 mm to Ø900 mm	<b>Drum diameter</b> from Ø500 mm to Ø650 mm
<b>Drive system</b>	electric	electric	electric	<b>Drive system</b> electric, manual-electric
<b>Power supply</b>	230V	230V	12V	<b>Power supply</b> 12V/230V
<b>Motor</b>	12V/150W	18V/80W	from 24V/250W to 24V/350W	<b>Motor</b> 24V/250W
<b>Controller mount</b>	top bar	top bar	top bar	<b>Controller mount</b> top bar
<b>Circuit board</b>	HE-01V	MDD-1	SDD-2	<b>Circuit board</b> SDD-2DP
<b>Controller</b>	digital	potentiometer	digital	<b>Controller</b> digital



**CLASSIC**  
line

<b>ID</b>	41240079	41240021 or 41240020	41240033 or 41240032
<b>Drum diameter</b>	from Ø500 mm to Ø900 mm	from Ø720 mm to Ø1200 mm	from Ø720 mm to Ø1200 mm
<b>Drive system</b>	electric, manual-electric	electric	electric
<b>Power supply</b>	12V/230V	230V	230V
<b>Motor</b>	24V/250W	0,37kW 400V, 0,55kW 400V, 0,75kW 400V	0,37kW 400V, 0,55kW 400V, 0,75kW 400V
<b>Controller mount</b>	leg	leg or top bar	leg or top bar
<b>Circuit board</b>	SDD-2DP	HE-02H	HES-02
<b>Controller</b>	digital	digital	potentiometer



Powder coated in red

**PREMIUM**  
line

<b>ID</b>	41240051	41240102	41240038
<b>Drum diameter</b>	Ø600 mm	from Ø720 mm to Ø1200 mm	from Ø720 mm to Ø1200 mm
<b>Drive system</b>	electric, manual-electric	electric	electric
<b>Power supply</b>	12V/230V	230V	230V
<b>Motor</b>	24V/350W	0,55kW 400V, 0,75kW 400V	0,55kW 400V, 0,75kW 400V
<b>Controller mount</b>	leg	leg	leg
<b>Circuit board</b>	SDD-3	HE-03	HE-03
<b>Controller</b>	digital	LCD	LCD

110V controllers available

Ø500



**BASIC**  
line

**MINIMA**  
line

**MINIMA**  
line

<b>ID</b>	<b>W229BB</b>	<b>W229B</b>	<b>W266</b>
<b>Name</b>	Radial honey extractor Ø500mm, manual drive	Radial honey extractor Ø500 mm, manual drive	Radial honey extractor Ø500 mm, electric drive

**TECHNICAL PARAMETERS**

<b>Drum diameter</b>	Ø500 mm	Ø500 mm	Ø500 mm
<b>Drive system</b>	Manual	Manual	Electric
<b>Power supply</b>	—	—	230V
<b>Controller</b>	—	—	MDD-01*
<b>Motor</b>	—	—	18V/80W

**DRUM AND BASKET CONSTRUCTION**

<b>Thickness</b>	drum 0,6 mm bottom 0,8 mm	drum 0,6 mm bottom 0,8 mm	drum 0,6 mm bottom 0,8 mm
<b>Honey gate</b>	Plastic 6/4"	Plastic 6/4"	Plastic 6/4"
<b>Top bar</b>	Flat bar 10 mm powder coated	Flat bar 10 mm powder coated	Flat bar 10 mm powder coated
<b>Cover</b>	4 mm acrylic glass	4 mm acrylic glass	4 mm acrylic glass
<b>Legs</b>	Short, powder coated	Short, powder coated	Short, powder coated
<b>Hinges</b>	Plastic 4 pcs.	Plastic 4 pcs.	Plastic 4 pcs.
<b>Basket material</b>	Stainless rod Ø8 mm	Stainless rod Ø8 mm	Stainless rod Ø8 mm
<b>Reinforcing frame</b>	None	None	None
<b>Drum rim</b>	None	None	None
<b>Drum height</b>	610 mm	610 mm	610 mm

**ADDITIONAL INFORMATION**

<b>Other</b>	For self-assembly (shipped in carton)	For self-assembly (shipped in carton)	For self-assembly (shipped in carton)
--------------	---------------------------------------	---------------------------------------	---------------------------------------

\* Possibility to install the left/right directional controller in electric extractors - additional fees apply



WARRANTY DETAILS,  
PAGE 254-255.

**number of frames (top bar: 28 mm standard, 35 mm hoffmann):**  
Dadant 1/2 (H: 145 mm) — 12  
Dadant 1/2 (H: 159 mm) — 12

Ø600



	<b>BASIC</b> line	<b>MINIMA</b> line	<b>MINIMA</b> line	<b>OPTIMA</b> line	<b>OPTIMA</b> line
<b>ID</b>	<b>W230BB</b>	<b>W255B</b>	<b>W230B</b>	<b>W230</b>	<b>W231</b>
<b>Name</b>	Radial honey extractor Ø600 mm, manual drive	Radial honey extractor Ø600 mm, manual drive	Radial honey extractor Ø600 mm, electric drive	Radial honey extractor Ø600 mm, electric drive	Radial honey extractor Ø600 mm, manual+electric drive

**TECHNICAL PARAMETERS**

<b>Drum diameter</b>	Ø600 mm	Ø600 mm	Ø600 mm	Ø600 mm	Ø600 mm
<b>Drive system</b>	Electric	Manual	Electric	Electric	Manual + electric
<b>Power supply</b>	230V	—	230V	12V/230V	12V/230V
<b>Controller</b>	MDD-01*	—	MDD-01*	CDD*	CDD
<b>Motor</b>	18V/80W	—	18V/80W	24V/250W	24V/250W

**DRUM AND BASKET CONSTRUCTION**

<b>Thickness</b>	drum 0,6 mm bottom 0,8 mm	drum 0,6 mm bottom 0,8 mm	drum 0,6 mm bottom 0,8 mm	drum 0,6 mm bottom 0,8 mm	drum 0,6 mm bottom 0,8 mm
<b>Honey gate</b>	Plastic 6/4"	Plastic 6/4"	Plastic 6/4"	Stainless 6/4"	Stainless 6/4"
<b>Top bar</b>	Flat bar 10 mm po- wder coated	Flat bar 10 mm po- wder coated	Flat bar 10 mm po- wder coated	Flat bar 10 mm po- wder coated	Flat bar 10 mm po- wder coated
<b>Cover</b>	4 mm acrylic glass	4 mm acrylic glass	4 mm acrylic glass	4 mm acrylic glass	4 mm acrylic glass
<b>Legs</b>	Short, powder coated	Short, powder coated	Short, powder coated	Short, powder coated	Short, powder coated
<b>Hinges</b>	Plastic 4 pcs.	Plastic 4 pcs.	Plastic 4 pcs.	Plastic 4 pcs.	Plastic 4 pcs.
<b>Basket material</b>	Stainless rod Ø8 mm	Stainless rod Ø8 mm	Stainless rod Ø8 mm	Stainless rod Ø8 mm	Stainless rod Ø8 mm
<b>Reinforcing frame</b>	None	None	None	None	None
<b>Drum rim</b>	None	None	None	None	None
<b>Drum height</b>	610 mm	610 mm	610 mm	610 mm	610 mm

**ADDITIONAL INFORMATION**

<b>Other</b>	For self-assembly (shipped in carton)	For self-assembly (shipped in carton)	For self-assembly (shipped in carton)	For self-assembly (shipped in carton)	For self-assembly (shipped in carton)
--------------	---------------------------------------	---------------------------------------	---------------------------------------	---------------------------------------	---------------------------------------

\* Possibility to install the left/right directional controller in electric extractors - additional fees apply

**number of frames (top bar: 28 mm standard, 35 mm hoffmann):**

Dadant 1/2 (H: 145 mm) — 20

Dadant 1/2 (H: 159 mm) — 20

Langstroth 1/2 - 20



WARRANTY DETAILS,  
PAGE 254-255.

Ø600



**CLASSIC**  
line

**W255C**



**CLASSIC**  
line

**W216**



**PREMIUM**  
line

**W202P**



**PREMIUM**  
line

**W203P**

<b>ID</b>	<b>W255C</b>	<b>W216</b>	<b>W202P</b>	<b>W203P</b>
<b>Name</b>	Radial honey extractor Ø600 mm, manual drive	Radial honey extractor Ø600 mm, electric drive	Radial honey extractor Ø600 mm, electric drive	Radial honey extractor Ø600 mm, manual+electric drive

**TECHNICAL PARAMETERS**

<b>Drum diameter</b>	Ø600 mm	Ø600 mm	Ø600 mm	Ø600 mm
<b>Drive system</b>	Manual	Electric	Electric	Manual + electric
<b>Power supply</b>	—	12V/230V	12V/230V	12V/230V
<b>Controller</b>	—	SDD-2DP*	SDD-3	SDD-3
<b>Motor</b>	—	24V/250W	24V/350W	24V/350W

**DRUM AND BASKET CONSTRUCTION**

<b>Thickness</b>	drum 0,6 mm bottom 0,8 mm	drum 0,6 mm bottom 0,8 mm	0,8 mm	0,8 mm
<b>Honey gate</b>	Stainless 6/4"	Stainless 6/4"	Stainless 6/4"	Stainless 6/4"
<b>Top bar</b>	Flat bar 10 mm powder coated	Flat bar 10 mm powder coated	Flat bar 10 mm stainless	Flat bar 10 mm stainless
<b>Cover</b>	4 mm acrylic glass	4 mm acrylic glass	5 mm acrylic glass	5 mm acrylic glass
<b>Legs</b>	Long, powder coated	Long, powder coated	Long stainless	Long stainless
<b>Hinges</b>	Plastic 4 pcs.	Plastic 4 pcs.	Stainless 4 pcs.	Stainless 4 pcs.
<b>Basket material</b>	Stainless rod Ø8 mm	Stainless rod Ø8 mm	Stainless rod Ø10 mm	Stainless rod Ø10 mm
<b>Reinforcing frame</b>	Powder coated	Powder coated	Stainless	Stainless
<b>Drum rim</b>	Powder coated	Powder coated	Stainless	Stainless
<b>Drum height</b>	610 mm	610 mm	610 mm	610 mm

**ADDITIONAL INFORMATION**

<b>Other</b>	Shipped on pallet (packed in carton)	Shipped on pallet (packed in carton)	Shipped on pallet (packed in carton)	Shipped on pallet (packed in carton)
--------------	--------------------------------------	--------------------------------------	--------------------------------------	--------------------------------------

\* Possibility to install the left/right directional controller in electric extractors - additional fees apply

**number of frames (top bar: 28 mm standard, 35 mm hoffmann):**

Dadant 1/2 (H: 145 mm) — 20

Dadant 1/2 (H: 159mm) — 20

Langstroth 1/2 - 20



WARRANTY DETAILS,  
PAGE 254-255.

Ø650



**MINIMA**  
line

**MINIMA**  
line

**OPTIMA**  
line

**OPTIMA**  
line

<b>ID</b>	<b>W267R</b>	<b>W267E</b>	<b>W268R</b>	<b>W268</b>
<b>Name</b>	Radial honey extractor Ø650 mm, manual drive	Radial honey extractor Ø650 mm, electric drive	Radial honey extractor Ø650 mm, manual drive	Radial honey extractor Ø650 mm, electric drive

**TECHNICAL PARAMETERS**

<b>Drum diameter</b>	Ø650 mm	Ø650 mm	Ø650 mm	Ø650 mm
<b>Drive system</b>	Manual	Electric	Manual	Electric
<b>Power supply</b>	—	230V	—	12V/230V
<b>Controller</b>	—	MDD-01*	—	CDD*
<b>Motor</b>	—	18V/80W	—	24V/250W

**DRUM AND BASKET CONSTRUCTION**

<b>Thickness</b>	drum 0,6 mm bottom 0,8 mm	drum 0,6 mm bottom 0,8 mm	drum 0,6 mm bottom 0,8 mm	drum 0,6 mm bottom 0,8 mm
<b>Honey gate</b>	Plastic 6/4"	Plastic 6/4"	Stainless 6/4"	Stainless 6/4"
<b>Top bar</b>	Flat bar 10 mm powder coated	Flat bar 10 mm powder coated	Flat bar 10 mm stainless	Flat bar 10 mm stainless
<b>Cover</b>	4 mm acrylic glass	4 mm acrylic glass	4 mm acrylic glass	4 mm acrylic glass
<b>Legs</b>	Short, powder coated	Short, powder coated	Short, powder coated	Short, powder coated
<b>Hinges</b>	Plastic 4 pcs.	Plastic 4 pcs.	Plastic 4 pcs.	Plastic 4 pcs.
<b>Basket material</b>	Stainless rod Ø8 mm	Stainless rod Ø8 mm	Stainless rod Ø8 mm	Stainless rod Ø8 mm
<b>Reinforcing frame</b>	None	None	None	None
<b>Drum rim</b>	None	None	None	None
<b>Drum height</b>	610 mm	610 mm	610 mm	610 mm

**ADDITIONAL INFORMATION**

<b>Other</b>	For self-assembly (shipped in carton)	For self-assembly (shipped in carton)	For self-assembly (shipped in carton)	For self-assembly (shipped in carton)
--------------	--	--	--	--

\* Possibility to install the left/right directional controller in electric extractors - additional fees apply



WARRANTY DETAILS,  
PAGE 254-255.

**number of frames (top bar: 28 mm standard, 35 mm hoffmann):**  
Langstroth — 9

Ø650



**OPTIMA**  
line

**CLASSIC**  
line

**CLASSIC**  
line

**CLASSIC**  
line

<b>ID</b>	<b>W268RE</b>	<b>W270</b>	<b>W271</b>	<b>W271RE</b>
<b>Name</b>	Radial honey extractor Ø650 mm, manual+electric drive	Radial honey extractor Ø650 mm, manual drive	Radial honey extractor Ø650 mm, electric drive	Radial honey extractor Ø650 mm, manual+electric drive

**TECHNICAL PARAMETERS**

<b>Drum diameter</b>	Ø650 mm	Ø650 mm	Ø650 mm	Ø650 mm
<b>Drive system</b>	Manual + electric	Manual	Electric	Manual + electric
<b>Power supply</b>	12V/230V	—	12V/230V	12V/230V
<b>Controller</b>	CDD	—	SDD-2DP*	SDD-2DP
<b>Motor</b>	24V/250W	—	24V/250W	24V/250W

**DRUM AND BASKET CONSTRUCTION**

<b>Thickness</b>	drum 0,6 mm bottom 0,8 mm	drum 0,6 mm bottom 0,8 mm	drum 0,6 mm bottom 0,8 mm	drum 0,6 mm bottom 0,8 mm
<b>Honey gate</b>	Stainless 6/4"	Stainless 6/4"	Stainless 6/4"	Stainless 6/4"
<b>Top bar</b>	Flat bar 10 mm powder coated	Flat bar 10 mm powder coated	Flat bar 10 mm powder coated	Flat bar 10 mm powder coated
<b>Cover</b>	4 mm acrylic glass	4 mm acrylic glass	4 mm acrylic glass	4 mm acrylic glass
<b>Legs</b>	Short, powder coated	Long, powder coated	Long, powder coated	Long, powder coated
<b>Hinges</b>	Plastic 4 pcs.	Plastic 4 pcs.	Plastic 4 pcs.	Plastic 4 pcs.
<b>Basket material</b>	Stainless rod Ø8 mm	Stainless rod Ø8 mm	Stainless rod Ø8 mm	Stainless rod Ø8 mm
<b>Reinforcing frame</b>	None	Powder coated	Powder coated	Powder coated
<b>Drum rim</b>	None	Powder coated	Powder coated	Powder coated
<b>Drum height</b>	610 mm	610 mm	610 mm	610 mm

**ADDITIONAL INFORMATION**

<b>Other</b>	For self-assembly (shipped in carton)	Shipped on pallet (packed in carton)	Shipped on pallet (packed in carton)	Shipped on pallet (packed in carton)
--------------	--	---	---	---

\* Possibility to install the left/right directional controller in electric extractors - additional fees apply



WARRANTY DETAILS,  
PAGE 254-255.

**number of frames (top bar: 28 mm standard, 35 mm hoffmann):**  
Langstroth — 9

Ø650



**MINIMA**  
line

**MINIMA**  
line

**OPTIMA**  
line

**OPTIMA**  
line

ID	W267R12	W267E12	W268R12	W268E12
Name	Radial honey extractor Ø650 mm, manual drive	Radial honey extractor Ø650 mm, electric drive	Radial honey extractor Ø650 mm, manual drive	Radial honey extractor Ø650 mm, electric drive

**TECHNICAL PARAMETERS**

Drum diameter	Ø650 mm	Ø650 mm	Ø650 mm	Ø650 mm
Drive system	Manual	Electric	Manual	Electric
Power supply	—	230V	—	12V/230V
Controller	—	MDD-01*	—	CDD*
Motor	—	18V/80W	—	24V/250W

**DRUM AND BASKET CONSTRUCTION**

Thickness	drum 0,6 mm bottom 0,8 mm	drum 0,6 mm bottom 0,8 mm	drum 0,6 mm bottom 0,8 mm	drum 0,6 mm bottom 0,8 mm
Honey gate	Plastic 6/4"	Plastic 6/4"	Stainless 6/4"	Stainless 6/4"
Top bar	Flat bar 10 mm powder coated	Flat bar 10 mm powder coated	Flat bar 10 mm stainless	Flat bar 10 mm stainless
Cover	4 mm acrylic glass	4 mm acrylic glass	4 mm acrylic glass	4 mm acrylic glass
Legs	Short, powder coated	Short, powder coated	Short, powder coated	Short, powder coated
Hinges	Plastic 4 pcs.	Plastic 4 pcs.	Plastic 4 pcs.	Plastic 4 pcs.
Basket material	Stainless rod Ø8 mm	Stainless rod Ø8 mm	Stainless rod Ø8 mm	Stainless rod Ø8 mm
Reinforcing frame	None	None	None	None
Drum rim	None	None	None	None
Drum height	610 mm	610 mm	610 mm	610 mm

**ADDITIONAL INFORMATION**

Other	For self-assembly (shipped in carton)	For self-assembly (shipped in carton)	For self-assembly (shipped in carton)	For self-assembly (shipped in carton)
-------	---------------------------------------	---------------------------------------	---------------------------------------	---------------------------------------

\* Possibility to install the left/right directional controller in electric extractors - additional fees apply



WARRANTY DETAILS,  
PAGE 254-255.

number of frames (top bar: 28 mm standard, 35 mm hoffmann):  
Langstroth — 12

Ø650



**OPTIMA**  
line

**CLASSIC**  
line

**CLASSIC**  
line

**CLASSIC**  
line

<b>ID</b>	<b>W268RE12</b>	<b>W270R12</b>	<b>W271E12</b>	<b>W271RE12</b>
<b>Name</b>	Radial honey extractor Ø650 mm, manual+electric drive	Radial honey extractor Ø650 mm, manual drive	Radial honey extractor Ø650 mm, electric drive	Radial honey extractor Ø650 mm, manual+electric drive

**TECHNICAL PARAMETERS**

<b>Drum diameter</b>	Ø650 mm	Ø650 mm	Ø650 mm	Ø650 mm
<b>Drive system</b>	Manual + electric	Manual	Electric	Manual + electric
<b>Power supply</b>	12V/230V	—	12V/230V	12V/230V
<b>Controller</b>	CDD	—	SDD-2DP*	SDD-2DP
<b>Motor</b>	24V/250W	—	24V/250W	24V/250W

**DRUM AND BASKET CONSTRUCTION**

<b>Thickness</b>	drum 0,6 mm bottom 0,8 mm	drum 0,6 mm bottom 0,8 mm	drum 0,6 mm bottom 0,8 mm	drum 0,6 mm bottom 0,8 mm
<b>Honey gate</b>	Stainless 6/4"	Stainless 6/4"	Stainless 6/4"	Stainless 6/4"
<b>Top bar</b>	Flat bar 10 mm powder coated	Flat bar 10 mm powder coated	Flat bar 10 mm powder coated	Flat bar 10 mm powder coated
<b>Cover</b>	4 mm acrylic glass	4 mm acrylic glass	4 mm acrylic glass	4 mm acrylic glass
<b>Legs</b>	Short, powder coated	Long, powder coated	Long, powder coated	Long, powder coated
<b>Hinges</b>	Plastic 4 pcs.	Plastic 4 pcs.	Plastic 4 pcs.	Plastic 4 pcs.
<b>Basket material</b>	Stainless rod Ø8 mm	Stainless rod Ø8 mm	Stainless rod Ø8 mm	Stainless rod Ø8 mm
<b>Reinforcing frame</b>	None	Powder coated	Powder coated	Powder coated
<b>Drum rim</b>	None	Powder coated	Powder coated	Powder coated
<b>Drum height</b>	610 mm	610 mm	610 mm	610 mm

**ADDITIONAL INFORMATION**

<b>Other</b>	For self-assembly (shipped in carton)	Shipped on pallet (packed in carton)	Shipped on pallet (packed in carton)	Shipped on pallet (packed in carton)
--------------	--	---	---	---

\* Possibility to install the left/right directional controller in electric extractors - additional fees apply



WARRANTY DETAILS,  
PAGE 254-255.

**number of frames (top bar: 28 mm standard, 35 mm hoffmann):**  
Langstroth — 12

Ø720



**BASIC**  
line

**OPTIMA**  
line

**CLASSIC**  
line

**PREMIUM**  
line

<b>ID</b>	<b>W217_B</b>	<b>W217</b>	<b>W20100G</b> <b>W201000G</b>	<b>W201000_P</b>
<b>Name</b>	Radial honey extractor Ø720mm, electric drive	Radial honey extractor Ø720 mm, electric drive	Radial honey extractor Ø720 mm, electric drive, semi-automatic/automatic	Radial honey extractor Ø720 mm, electric drive

**WTECHNICAL PARAMETERS**

<b>Drum diameter</b>	Ø720 mm	Ø720 mm	Ø720 mm	Ø720 mm
<b>Drive system</b>	Electric bottom	Electric bottom	Electric top	Electric bottom
<b>Power supply</b>	230V	12V/230V	230V	230V
<b>Controller</b>	HE-01V	SDD-2DP	HES-02* HE-02H*	HE-03
<b>Motor</b>	Belt drive 12V/150W	Belt drive 24V/350W	Motoreducer 0,37kW	Motoreducer 0,55kW

**DRUM AND BASKET CONSTRUCTION**

<b>Drum thickness</b>	0,6 mm	0,6 mm	0,6 mm	0,8 mm
<b>Honey gate</b>	Stainless 6/4"	Stainless 6/4"	Stainless 6/4"	Stainless 6/4"
<b>Top bar</b>	Powder coated plate	Powder coated plate	Flat bar 100x10 mm Powder coated	Flat bar 60x10 mm Stainless
<b>Cover</b>	4 mm acrylic glass	4 mm acrylic glass	4 mm acrylic glass	8 mm acrylic glass
<b>Legs</b>	Two-piece, unassembled, powder coated	Powder coated 50x30 mm	Powder coated 50x30 mm	Stainless 50x30 mm
<b>Hinges</b>	Plastic 4 pcs.	Plastic 4 pcs.	Plastic 2 pcs.	Stainless 8 pcs.
<b>Basket material</b>	Stainless rod Ø8 and Ø6 mm	Stainless rod Ø8 and Ø6 mm	Stainless rod Ø8 and Ø6 mm	Stainless rod Ø10 and Ø8 mm
<b>Reinforcing frame</b>	Powder coated	Powder coated	Powder coated	Stainless
<b>Drum rim</b>	Powder coated	Powder coated	Powder coated	Stainless
<b>Drum height</b>	645 mm	645 mm	645 mm	730 mm

**ADDITIONAL INFORMATION**

<b>Other</b>	For self-assembly (shipped in carton)	Shipped on pallet	Shipped on pallet	Shipped on pallet
--------------	---------------------------------------	-------------------	-------------------	-------------------

\* Classic line extractors: controller can be exchanged for advanced automatic controller (HE-03) for an extra charge



WARRANTY DETAILS,  
PAGE 254-255.

**number of frames (top bar: 28 mm standard, 37 mm hoffmann):**  
Langstroth — 18  
Dadant 1/2 (H: 145 or 159 mm) — 30  
Deutsch Normal - 18

Ø800



	<b>MINIMA</b> line	<b>BASIC</b> line	<b>OPTIMA</b> line	<b>CLASSIC</b> line	<b>PREMIUM</b> line
<b>ID</b>	<b>W20050M</b>	<b>W218_B</b>	<b>W218</b>	<b>W200500G W2005000G</b>	<b>W2005000_P</b>
<b>Name</b>	Radial honey extractor Ø800 mm, electric drive	Radial honey extractor Ø800mm, electric drive	Radial honey extractor Ø800 mm, electric drive	Radial honey extractor Ø800 mm, electric drive, semi-automatic/automatic	Radial honey extractor Ø800 mm, electric drive

**TECHNICAL PARAMETERS**

<b>Drum diameter</b>	Ø800 mm	Ø800 mm	Ø800 mm	Ø800 mm	Ø800 mm
<b>Drive system</b>	Electric bottom	Electric bottom	Electric bottom	Electric top	Electric bottom
<b>Power supply</b>	12V	230V	12V/230V	230V	230V
<b>Controller</b>	SDD-2	HE-01V	SDD-2DP	HES-02* HE-02H*	HE-03
<b>Motor</b>	Belt drive 24V/350W	Belt drive 12V/150W	Belt drive 24V/350W	Motoreducer 0,37kW	Motoreducer 0,55kW

**DRUM AND BASKET CONSTRUCTION**

<b>Drum thickness</b>	0,6 mm	0,6 mm	0,6 mm	0,6 mm	0,8 mm
<b>Honey gate</b>	Plastic 6/4"	Stainless 6/4"	Stainless 6/4"	Stainless 6/4"	Stainless 6/4"
<b>Top bar</b>	Powder coated plate	Powder coated plate	Powder coated plate	Flat bar 100x10 mm Powder coated	Flat bar 60x10 mm Stainless
<b>Cover</b>	4 mm acrylic glass	4 mm acrylic glass	4 mm acrylic glass	4 mm acrylic glass	8 mm acrylic glass
<b>Legs</b>	Powder coated 40x27 mm	Two-piece, unassembled, powder coated	Powder coated 50x30 mm	Powder coated 50x30 mm	Stainless 50x30 mm
<b>Hinges</b>	Plastic 4 pcs.	Plastic 4 pcs.	Plastic 8 pcs.	Plastic 4 pcs.	Stainless 8 pcs.
<b>Basket material</b>	Stainless rod Ø8 and Ø6 mm	Stainless rod Ø8 and Ø6 mm	Stainless rod Ø8 and Ø6 mm	Stainless rod Ø8 and Ø6 mm	Stainless rod Ø10 and Ø8 mm
<b>Reinforcing frame</b>	Powder coated	Powder coated	Powder coated	Powder coated	Stainless
<b>Drum rim</b>	Powder coated	Powder coated	Powder coated	Powder coated	Stainless
<b>Drum height</b>	645 mm	645 mm	645 mm	645 mm	730 mm

**ADDITIONAL INFORMATION**

<b>Other</b>	Shipped on pallet	For self-assembly (shipped in carton)	Shipped on pallet	Shipped on pallet	Shipped on pallet
--------------	-------------------	---------------------------------------	-------------------	-------------------	-------------------

\* Classic line extractors: controller can be exchanged for advanced automatic controller (HE-03) for an extra charge

**number of frames (top bar: 28 mm standard, 37 mm hoffmann):**  
 Deutsch Normal — 30  
 Langstroth — 30  
 Dadant 1/2 — 30



WARRANTY DETAILS,  
PAGE 254-255.

Ø900



	<b>MINIMA</b> line	<b>BASIC</b> line	<b>OPTIMA</b> line	<b>CLASSIC</b> line	<b>PREMIUM</b> line
<b>ID</b>	<b>W20060M</b>	<b>W219_B</b>	<b>W219</b>	<b>W200600G W2006000G</b>	<b>W2006000_P</b>
<b>Name</b>	Radial honey extractor Ø900 mm, electric drive	Radial honey extractor Ø900mm, electric drive	Radial honey extractor Ø900 mm, electric drive	Radial honey extractor Ø900 mm, electric drive, semi-automatic/automatic	Radial honey extractor Ø900 mm, electric drive

**TECHNICAL PARAMETERS**

<b>Drum diameter</b>	Ø900 mm	Ø900 mm	Ø900 mm	Ø900 mm	Ø900 mm
<b>Drive system</b>	Electric bottom	Electric bottom	Electric bottom	Electric top	Electric bottom
<b>Power supply</b>	12V	230V	12V/230V	230V	230V
<b>Controller</b>	SDD-2	HE-01V	SDD-2DP	HES-02* HE-02H*	HE-03
<b>Motor</b>	Belt drive 24V/350W	Belt drive 12V/150W	Belt drive 24V/350W	motoreducer 0,55kW	motoreducer 0,55kW

**DRUM AND BASKET CONSTRUCTION**

<b>Drum thickness</b>	0,6 mm	0,6 mm	0,6 mm	0,6 mm	0,8 mm
<b>Honey gate</b>	Plastic 6/4"	Stainless 6/4"	Stainless 6/4"	Stainless 6/4"	Stainless 6/4"
<b>Top bar</b>	Powder coated plate	Powder coated plate	Powder coated plate	Flat bar 100x10 mm Powder coated	Flat bar 60x10 mm Stainless
<b>Cover</b>	4 mm acrylic glass	4 mm acrylic glass	4 mm acrylic glass	4 mm acrylic glass	8 mm acrylic glass
<b>Legs</b>	Powder coated 40x27 mm	Two-piece, unassembled, powder coated	Powder coated 50x30 mm	Powder coated 50x30 mm	Stainless 50x30 mm
<b>Hinges</b>	Plastic 4 pcs.	Plastic 4 pcs.	Plastic 8 pcs.	Plastic 4 pcs.	Stainless 8 pcs.
<b>Basket material</b>	Stainless rod Ø8 and Ø6 mm	Stainless rod Ø8 and Ø6 mm	Stainless rod Ø8 and Ø6 mm	Stainless rod Ø8 and Ø6 mm	Stainless rod Ø10 and Ø8 mm
<b>Reinforcing frame</b>	Powder coated	Powder coated	Powder coated	Powder coated	Stainless
<b>Drum rim</b>	Powder coated	Powder coated	Powder coated	Powder coated	Stainless
<b>Drum height</b>	645 mm	645 mm	645 mm	645 mm	730 mm

**ADDITIONAL INFORMATION**

<b>Other</b>	Shipped on pallet	For self-assembly (shipped in carton)	Shipped on pallet	Shipped on pallet	Shipped on pallet
--------------	-------------------	---------------------------------------	-------------------	-------------------	-------------------

\* Classic line extractors: controller can be exchanged for advanced automatic controller (HE-03) for an extra charge



WARRANTY DETAILS,  
PAGE 254-255.

**number of frames (top bar: 28 mm standard, 37 mm hoffmann):**  
Deutsch Normal — 42  
Langstroth — 42  
Dadant/Dadant 1/2 — 24/42

Ø1000



**CLASSIC**  
line

**CLASSIC**  
line

**PREMIUM**  
line

<b>ID</b>	<b>W200700</b>	<b>W2007000</b>	<b>W2007000_P</b>
<b>Name</b>	Radial honey extractor Ø1000 mm, electric drive, semi-automatic	Radial honey extractor Ø1000 mm, electric drive, automatic	Radial honey extractor Ø1000 mm, electric drive

**TECHNICAL PARAMETERS**

<b>Drum diameter</b>	Ø1000 mm	Ø1000 mm	Ø1000 mm
<b>Drive system</b>	Electric bottom	Electric bottom	Electric bottom
<b>Power supply</b>	230V	230V	230V
<b>Controller</b>	HES-02*	HE-02H*	HE-03
<b>Motor</b>	Motoreducer 0,75kW	Motoreducer 0,75kW	Motoreducer 0,75kW

**DRUM AND BASKET CONSTRUCTION**

<b>Thickness</b>	drum 0,6 mm bottom 0,8 mm	drum 0,6 mm bottom 0,8 mm	0,8 mm
<b>Honey gate</b>	2*stainless 2"	2*stainless 2"	2*stainless 2"
<b>Top bar</b>	Flat bar 60x10 mm powder coated	Flat bar 60x10 mm powder coated	Flat bar 60x10 mm stainless
<b>Cover</b>	4 mm acrylic glass	4 mm acrylic glass	8 mm acrylic glass
<b>Legs</b>	Powder coated 60x40 mm	Powder coated 60x40 mm	Stainless 60x40 mm
<b>Hinges</b>	Plastic 8 pcs.	Plastic 8 pcs.	Stainless 8 pcs.
<b>Basket material</b>	Stainless rod Ø10 and Ø8 mm	Stainless rod Ø10 and Ø8 mm	Stainless rod Ø10 and flat bar 30x5 mm
<b>Reinforcing frame</b>	Powder coated	Powder coated	Stainless
<b>Drum rim</b>	Powder coated	Powder coated	Stainless
<b>Drum height</b>	685 mm	685 mm	730 mm

**ADDITIONAL INFORMATION**

<b>Other</b>	Shipped on pallet	Shipped on pallet	Shipped on pallet
--------------	-------------------	-------------------	-------------------

\* Classic line extractors: controller can be exchanged for advanced automatic controller (HE-03) for an extra charge

**number of frames (top bar: 28 mm standard, 37 mm hoffmann):**  
 Deutsch Normal — 42  
 Langstroth — 42  
 Dadant / Dadant 1/2 — 36/42



WARRANTY DETAILS,  
PAGE 254-255.

Ø1200



**CLASSIC**  
line

**CLASSIC**  
line

**PREMIUM**  
line

<b>ID</b>	<b>W200800</b>	<b>W2008000</b>	<b>W2008000_P</b>
<b>Name</b>	Radial honey extractor Ø1200 mm, electric drive semi-automatic	Radial honey extractor Ø1200 mm, electric drive automatic	Radial honey extractor Ø1200 mm, electric drive

**TECHNICAL PARAMETERS**

<b>Drum diameter</b>	Ø1200 mm	Ø1200 mm	Ø1200 mm
<b>Drive system</b>	Electric bottom	Electric bottom	Electric bottom
<b>Power supply</b>	230V	230V	230V
<b>Controller</b>	HES-02*	HE-02H*	HE-03
<b>Motor</b>	Motoreducer 0,75kW	Motoreducer 0,75kW	Motoreducer 0,75kW

**DRUM AND BASKET CONSTRUCTION**

<b>Thickness</b>	drum 0,6 mm bottom 0,8 mm	drum 0,6 mm bottom 0,8 mm	0,8 mm
<b>Honey gate</b>	2*stainless 2"	2*stainless 2"	2*stainless 2"
<b>Top bar</b>	Flat bar 60x10 mm powder coated	Flat bar 60x10 mm powder coated	Flat bar 60x10 mm stainless
<b>Cover</b>	5 mm acrylic glass	5 mm acrylic glass	8 mm acrylic glass
<b>Legs</b>	Powder coated 60x40 mm	Powder coated 60x40 mm	Stainless 60x40 mm
<b>Hinges</b>	Plastic 8 pcs.	Plastic 8 pcs.	Stainless 8 pcs.
<b>Basket material</b>	Stainless rod Ø8 and flat bar 30x5 mm	Stainless rod Ø8 and flat bar 30x5 mm	Stainless rod Ø10 and flat bar 30x5 mm
<b>Reinforcing frame</b>	Powder coated	Powder coated	Stainless
<b>Drum rim</b>	Powder coated	Powder coated	Stainless
<b>Drum height</b>	685 mm	685 mm	730 mm

**ADDITIONAL INFORMATION**

<b>Other</b>	Shipped on pallet	Shipped on pallet	Shipped on pallet
--------------	-------------------	-------------------	-------------------

\* Classic line extractors: controller can be exchanged for advanced automatic controller (HE-03) for an extra charge



WARRANTY DETAILS,  
PAGE 254-255.

**number of frames (top bar: 28 mm standard, 37 mm hoffmann):**  
Deutsch Normal — 56  
Langstroth — 56  
Dadant / Dadant 1/2 — 56/56

# CASSETTE HONEY EXTRACTORS



## CLASSIC line

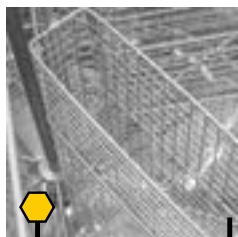

Large basket with 20x20mm mesh which allows spinning various types of frames

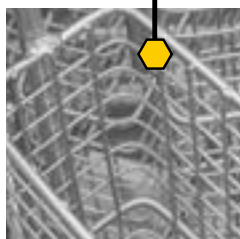

Baskets with smooth, polished welds – no risk of injury when inserting frames into the honey extractor



Safety lock - when the lid is opened, the honey extractor is stopped.



Drum height 650 mm to 780 mm made of acid-resistant stainless steel



A modern controller, which allows you to change the direction of the basket, so that the cassette swings to the right side once to the left side, there is no need to manually rotate the frames! The controller has 20 automatic programmes and two manual programmes (right-left)



The drive consists of a worm gear and a three-phase induction motor.



Basket made of rod 10mm and 8mm in acid-resistant stainless steel.



Stainless steel valve mounted at the bottom



STAINLESS STEEL AISI316



STAINLESS ACID-RESISTANT STEEL AISI304



THE DEVICE COMPLIES WITH THE LEGAL REQUIREMENTS APPLICABLE IN THE EU



IMPORTANT INFORMATION



	BASIC line		MINIMA line		OPTIMA line	
--	------------	--	-------------	--	-------------	--

<b>ID</b>	41240186	ZESTAW_BASIC OR ZESTAW_MINIMA	41240151	<b>ID</b>	41240064	41240011
<b>Drum diameter</b>	from Ø720 mm to Ø900 mm	from Ø600 mm to Ø650 mm	from Ø720 mm to Ø1000 mm	<b>Drum diameter</b>	from Ø600 mm to Ø650 mm	from Ø720 mm to Ø1200 mm
<b>Drive system</b>	electric	electric	electric	<b>Drive system</b>	electric, manual-electric	manual-electric
<b>Power supply</b>	230V	230V	12V	<b>Power supply</b>	12V/230V	12V/230V
<b>Motor</b>	12V/150W	18V/80W	from 24V/250W to 24V/350W	<b>Motor</b>	24V/250W	from 24V/250W to 24V/350W
<b>Controller mount</b>	top bar	top bar	top bar	<b>Controller mount</b>	top bar	leg
<b>Circuit board</b>	HE-01V	MDD-1	HE-01U	<b>Circuit board</b>	SDD-2DP	HE-01V
<b>Controller</b>	digital	potentiometer	digital	<b>Controller</b>	digital	digital



Powder coated in red

	CLASSIC line		PREMIUM line	
--	--------------	--	--------------	--

<b>ID</b>	41240021 or 41240020	41240033 or 41240032	<b>ID</b>	41240102
<b>Drum diameter</b>	from Ø720 mm to Ø1200 mm	from Ø720 mm to Ø1200 mm	<b>Drum diameter</b>	from Ø720 mm to Ø1200 mm
<b>Drive system</b>	electric	electric	<b>Drive system</b>	electric
<b>Power supply</b>	230V	230V	<b>Power supply</b>	230V
<b>Motor</b>	0,37kW 400V, 0,55kW 400V, 0,75kW 400V	0,37kW 400V, 0,55kW 400V, 0,75kW 400V	<b>Motor</b>	0,55kW 400V, 0,75kW 400V
<b>Controller mount</b>	leg or top bar	leg or top bar	<b>Controller mount</b>	leg
<b>Circuit board</b>	HE-02H	HES-02	<b>Circuit board</b>	HE-03
<b>Controller</b>	digital	potentiometer	<b>Controller</b>	LCD
<b>ID</b>	41240023	41240035	<b>ID</b>	41240040
<b>Drum diameter</b>	Ø1200 mm	Ø1200 mm	<b>Drum diameter</b>	Ø1200 mm
<b>Drive system</b>	electric	electric	<b>Drive system</b>	electric
<b>Power supply</b>	230V	230V	<b>Power supply</b>	230V
<b>Motor</b>	1,1kW 400V, 1,5kW 400V	1,1kW 400V, 1,5kW 400V	<b>Motor</b>	1,1kW 400V, 1,5kW 400V
<b>Controller mount</b>	leg	leg	<b>Controller mount</b>	leg
<b>Circuit board</b>	HE-02H	HES-02	<b>Circuit board</b>	HE-03
<b>Controller</b>	digital	potentiometer	<b>Controller</b>	LCD

110V controllers available

# 4-CASSETTE DADANT



**BASIC**  
line

**BASIC**  
line

**BASIC**  
line

**BASIC**  
line

ID	W222BB	W222BBF	W223BB	W223BBF
<b>Name</b>	Honey extractor 4-cassette Ø600 mm manual	Honey extractor 4-cassette Ø650 mm manual	Honey extractor 4-cassette Ø600 mm electric	Honey extractor 4-cassette Ø650 mm electric

## TECHNICAL PARAMETERS

	W222BB	W222BBF	W223BB	W223BBF
<b>Type of frame</b>	4×Dadant, 8×Dadant 1/2 (H=145 mm)	4×Dadant, 8×Dadant 1/2 (H=159 mm)	4×Dadant, 8×Dadant 1/2 (H=145 mm)	4×Dadant, 8×Dadant 1/2 (H=159 mm)
<b>Drum diameter</b>	Ø600 mm	Ø650 mm	Ø600 mm	Ø650 mm
<b>Drive system</b>	Manual	Manual	Electric	Electric
<b>Power supply</b>	—	—	230V	230V
<b>Controller</b>	—	—	MDD-01	MDD-01
<b>Motor</b>	—	—	18V/80W	18V/80W

## DRUM AND BASKET CONSTRUCTION

	W222BB	W222BBF	W223BB	W223BBF
<b>Thickness</b>	drum 0,6 mm bottom 0,8 mm	drum 0,6 mm bottom 0,8 mm	drum 0,6 mm bottom 0,8 mm	drum 0,6 mm bottom 0,8 mm
<b>Honey gate</b>	Plastic 6/4"	Plastic 6/4"	Plastic 6/4"	Plastic 6/4"
<b>Top bar</b>	Flat bar 10 mm powder coated	Flat bar 10 mm powder coated	Flat bar 10 mm powder coated	Flat bar 10 mm powder coated
<b>Cover</b>	4 mm acrylic glass	4 mm acrylic glass	4 mm acrylic glass	4 mm acrylic glass
<b>Legs</b>	Short, powder coated	Short, powder coated	Short, powder coated	Short, powder coated
<b>Hinges</b>	Plastic 4 pcs.	Plastic 4 pcs.	Plastic 4 pcs.	Plastic 4 pcs.
<b>Reinforcing frame</b>	None	None	None	None
<b>Cassette material</b>	Stainless rod Ø2 and Ø5 mm	Stainless rod Ø2 and Ø5 mm	Stainless rod Ø2 and Ø5 mm	Stainless rod Ø2 and Ø5 mm
<b>Drum rim</b>	None	None	None	None
<b>Drum height</b>	735 mm	735 mm	735 mm	735 mm

## ADDITIONAL INFORMATION

	W222BB	W222BBF	W223BB	W223BBF
<b>Other</b>	For self-assembly (shipped in carton)	For self-assembly (shipped in carton)	For self-assembly (shipped in carton)	For self-assembly (shipped in carton)



WARRANTY DETAILS,  
PAGE 254-255.

### dimensions of frames:

Dadant — 435x300 mm  
Dadant 1/2 — 435x145 mm (600mm)  
Dadant 1/2 — 435x159 mm (650mm)

### dimensions of cassettes:

440x305 mm (600mm)  
440x330 mm (650mm)

# 4-CASSETTE DADANT



## MINIMA line

W222BV

## MINIMA line

W223BV

<b>ID</b>		
<b>Name</b>	Honey extractor 4-cassette Ø600 mm manual	Honey extractor 4-cassette Ø600 mm electric

### TECHNICAL PARAMETERS

<b>Type of frame</b>	4xDadant, 8xDadant 1/2 (H=145 mm)	4xDadant, 8xDadant 1/2 (H=145 mm)
<b>Drum diameter</b>	Ø600 mm	Ø600 mm
<b>Drive system</b>	Manual	Electric
<b>Power supply</b>	—	230V
<b>Controller</b>	—	MDD-01
<b>Motor</b>	—	18V/80W

### DRUM AND BASKET CONSTRUCTION

<b>Thickness</b>	drum 0,6 mm bottom 0,8 mm	drum 0,6 mm bottom 0,8 mm
<b>Honey gate</b>	Stainless 6/4"	Stainless 6/4"
<b>Top bar</b>	Flat bar 10 mm powder coated	Flat bar 10 mm powder coated
<b>Cover</b>	4 mm acrylic glass	4 mm acrylic glass
<b>Legs</b>	Short, powder coated	Short, powder coated
<b>Hinges</b>	Plastic 4 pcs.	Plastic 4 pcs.
<b>Reinforcing frame</b>	None	None
<b>Cassette material</b>	Stainless rod Ø2 and Ø5 mm	Stainless rod Ø2 and Ø5 mm
<b>Drum rim</b>	None	None
<b>Drum height</b>	735 mm	735 mm

### ADDITIONAL INFORMATION

<b>Other</b>	For self-assembly (shipped in carton)	For self-assembly (shipped in carton)
--------------	---------------------------------------	---------------------------------------



WARRANTY DETAILS,  
PAGE 254-255.

**dimensions of frames:**  
Dadant — 435x300 mm  
Dadant 1/2 — 435x145 mm

**dimensions of cassettes:**  
440x305 mm

# 4-CASSETTE DADANT



	<b>OPTIMA</b> line	<b>OPTIMA</b> line	<b>OPTIMA</b> line
<b>ID</b>	<b>W222M</b>	<b>W223S</b>	<b>W221MS</b>
<b>Name</b>	Honey extractor 4-cassette Ø600 mm manual	Honey extractor 4-cassette Ø600 mm electric	Honey extractor 4-cassette Ø600 mm manual+electric
<b>TECHNICAL PARAMETERS</b>			
<b>Type of frame</b>	4×Dadant, 8×Dadant 1/2 (H: 145 mm)	4×Dadant, 8×Dadant 1/2 (H: 145 mm)	4×Dadant, 8×Dadant 1/2 (H: 145 mm)
<b>Drum diameter</b>	Ø600 mm	Ø600 mm	Ø600 mm
<b>Drive system</b>	Manual	Electric	Manual + electric
<b>Power supply</b>	—	230V	230V
<b>Controller</b>	—	CDD	CDD
<b>Motor</b>	—	24V/250W	24V/250W
<b>DRUM AND BASKET CONSTRUCTION</b>			
<b>Thickness</b>	drum 0,6 mm bottom 0,8 mm	drum 0,6 mm bottom 0,8 mm	drum 0,6 mm bottom 0,8 mm
<b>Honey gate</b>	Stainless 6/4"	Stainless 6/4"	Stainless 6/4"
<b>Top bar</b>	Flat bar 10 mm powder coated	Flat bar 10 mm powder coated	Flat bar 10 mm powder coated
<b>Cover</b>	4 mm acrylic glass	4 mm acrylic glass	4 mm acrylic glass
<b>Legs</b>	Short, powder coated	Short, powder coated	Short, powder coated
<b>Hinges</b>	Plastic 4 pcs.	Plastic 4 pcs.	Plastic 4 pcs.
<b>Reinforcing frame</b>	None	None	None
<b>Cassette material</b>	Stainless rod Ø2 and Ø5 mm	Stainless rod Ø2 and Ø5 mm	Stainless rod Ø2 and Ø5 mm
<b>Drum rim</b>	None	None	None
<b>Drum height</b>	735 mm	735 mm	735 mm
<b>ADDITIONAL INFORMATION</b>			
<b>Other</b>	For self-assembly (shipped in carton)	For self-assembly (shipped in carton)	For self-assembly (shipped in carton)



WARRANTY DETAILS,  
PAGE 254-255.

**dimensions of frames:**  
Dadant — 435x300 mm  
Dadant 1/2 — 435x145 mm

**dimensions of cassettes:**  
440x305 mm

# 4-CASSETTE DADANT



## OPTIMA line

## OPTIMA line

## OPTIMA line

ID	W222M_I	W223S_I	W221MS_I
Name	Honey extractor 4-cassette Ø650 mm manual	Honey extractor 4-cassette Ø650 mm electric	Honey extractor 4-cassette Ø650 mm manual+electric

### TECHNICAL PARAMETERS

Type of frame	4×Dadant, 8×Dadant 1/2 (H=159 mm)	4×Dadant, 8×Dadant 1/2 (H=159 mm)	4×Dadant, 8×Dadant 1/2 (H=159 mm)
Drum diameter	Ø650 mm	Ø650 mm	Ø650 mm
Drive system	Manual	Electric	Manual + electric
Power supply	—	230V	230V
Controller	—	CDD	CDD
Motor	—	24V/250W	24V/250W

### DRUM AND BASKET CONSTRUCTION

Thickness	drum 0,6 mm bottom 0,8 mm	drum 0,6 mm bottom 0,8 mm	drum 0,6 mm bottom 0,8 mm
Honey gate	Stainless 6/4"	Stainless 6/4"	Stainless 6/4"
Top bar	Flat bar 10 mm powder coated	Flat bar 10 mm powder coated	Flat bar 10 mm powder coated
Cover	4 mm acrylic glass	4 mm acrylic glass	4 mm acrylic glass
Legs	Short, powder coated	Short, powder coated	Short, powder coated
Hinges	Plastic 4 pcs.	Plastic 4 pcs.	Plastic 4 pcs.
Reinforcing frame	None	None	None
Cassette material	Stainless rod Ø2 and Ø5 mm	Stainless rod Ø2 and Ø5 mm	Stainless rod Ø2 and Ø5 mm
Drum rim	None	None	None
Drum height	735 mm	735 mm	735 mm

### ADDITIONAL INFORMATION

Other	For self-assembly (shipped in carton)	For self-assembly (shipped in carton)	For self-assembly (shipped in carton)
-------	--	--	--



WARRANTY DETAILS,  
PAGE 254-255.

**dimensions of frames:**  
Dadant — 435x300 mm  
Dadant 1/2 — 435x159 mm

**dimensions of cassettes:**  
440x330 mm

# 4-CASSETTE DADANT



	<b>MINIMA</b> line	<b>BASIC</b> line	<b>OPTIMA</b> line	<b>CLASSIC</b> line	<b>PREMIUM</b> line
<b>ID</b>	<b>W2013MKN</b>	<b>W2013KN_B</b>	<b>W2013KN</b>	<b>W2013K0MR</b> <b>W2013K00MR</b>	<b>W2013K00MR_P</b>
<b>Name</b>	Honey extractor 4-cassette Ø800 mm, electric drive	Honey extractor Ø800mm, 4-cassette, electric drive	Honey extractor 4-cassette Ø800 mm, electric drive	Honey extractor 4-cassette Ø800 mm, electric drive	Honey extractor 4-cassette Ø800 mm, electric drive
<b>TECHNICAL PARAMETERS</b>					
<b>Type of frame</b>	4×Dadant, 8×Dadant 1/2	4×Dadant, 8×Dadant ½	4×Dadant, 8×Dadant 1/2	4×Dadant, 8×Dadant 1/2	4×Dadant, 8×Dadant 1/2
<b>Drum diameter</b>	Ø800 mm	Ø800 mm	Ø800 mm	Ø800 mm	Ø800 mm
<b>Drive system</b>	Electric bottom	Electric bottom	Electric bottom	Electric bottom	Electric bottom
<b>Power supply</b>	12V	230V	12V/230V	230V	230V
<b>Controller</b>	HE-01U	HE-01V	HE-01V	HES-02* HE-02H*	HE-03
<b>Motor</b>	Belt drive 24V/280W	Belt drive 12V/150W	Belt drive 24V/280W	Motoreducer 0,37kW	Motoreducer 0,55kW
<b>DRUM AND BASKET CONSTRUCTION</b>					
<b>Drum thickness</b>	0,6 mm	0,6 mm	0,6 mm	0,6 mm	0,8 mm
<b>Honey gate</b>	Plastic 6/4"	Stainless 6/4"	Stainless 6/4"	Stainless 6/4"	Stainless 6/4"
<b>Top bar</b>	Powder coated plate	Powder coated plate	Powder coated plate	Powder coated plate	Flat bar 60x10 mm stainless
<b>Cover</b>	4 mm acrylic glass	4 mm acrylic glass	4 mm acrylic glass	4 mm acrylic glass	8 mm acrylic glass
<b>Legs</b>	Powder coated 40x27 mm	Two-piece, unassembled, powder coated	Powder coated 50x30 mm	Powder coated 50x30 mm	Stainless 50x30 mm
<b>Hinges</b>	Plastic 4 pcs.	Plastic 4 pcs.	Plastic 8 pcs.	Plastic 8 pcs.	Stainless 8 pcs.
<b>Reinforcing frame</b>	Powder coated	Powder coated	Powder coated	Powder coated	Stainless
<b>Cassette material</b>	Stainless rod Ø2 and Ø5 mm	Stainless rod Ø2 and Ø5 mm	Stainless rod Ø2 and Ø5 mm	Stainless rod Ø2 and Ø5 mm	Stainless rod Ø3 and Ø6 mm
<b>Drum rim</b>	Powder coated	Powder coated	Powder coated	Powder coated	Stainless
<b>Drum height</b>	740 mm	740 mm	740 mm	740 mm	780 mm
<b>ADDITIONAL INFORMATION</b>					
<b>Other</b>	Shipped on pallet	For self-assembly (shipped in carton)	Shipped on pallet	Shipped on pallet	Shipped on pallet

\* Classic line extractors: controller can be exchanged for advanced automatic controller (HE-03) for an extra charge



WARRANTY DETAILS,  
PAGE 254-255.

**dimensions of frames:**  
Dadant — 435x300 mm  
Dadant 1/2 — 435x159 mm

**dimensions of cassettes:**  
425x325 mm

# 4-CASSETTE DADANT



	<b>BASIC</b> line	<b>OPTIMA</b> line	<b>CLASSIC</b> line	<b>PREMIUM</b> line
<b>ID</b>	<b>W201300KN_B</b>	<b>W201300KN</b>	<b>W201300K00MR</b> <b>W20180MR</b>	<b>W20180MR_P</b>
<b>Name</b>	Honey extractor Ø900mm, 4-cassette, electric drive	4-cassette honey extrac- tor Ø900 mm, electric drive	4-cassette honey extractor Ø900 mm, electric drive, semi-automatic/automatic	4-cassette honey extrac- tor Ø900 mm electric drive

## TECHNICAL PARAMETERS

<b>Type of frame</b>	4×Dadant, 8×Dadant ½	4×Dadant, 8×Dadant 1/2	4×Dadant, 8×Dadant 1/2	4×Dadant, 8×Dadant 1/2
<b>Drum diameter</b>	Ø900 mm	Ø900 mm	Ø900 mm	Ø900 mm
<b>Drive system</b>	Electric bottom	Electric bottom	Electric bottom	Electric bottom
<b>Power supply</b>	230V	12V/230V	230V	230V
<b>Controller</b>	HE-01V	HE-01V	HES-02* HE-02H	HE-03
<b>Motor</b>	Belt drive 12V/150W	Belt drive 24V/280W	Motoreducer 0,37kW	Motoreducer 0,55kW

## DRUM AND BASKET CONSTRUCTION

<b>Drum thickness</b>	0,6 mm	0,6 mm	0,6 mm	0,8 mm
<b>Honey gate</b>	Stainless 6/4"	Stainless 6/4"	Stainless 6/4"	Stainless 6/4"
<b>Top bar</b>	Powder coated plate	Powder coated plate	Powder coated plate	Flat bar 60x10 mm stainless
<b>Cover</b>	4 mm acrylic glass	4 mm acrylic glass	4 mm acrylic glass	8 mm acrylic glass
<b>Legs</b>	Two-piece, unassembled, powder coated	Powder coated 50x30 mm	Powder coated 50x30 mm	Stainless 50x30 mm
<b>Hinges</b>	Plastic 4 pcs.	Plastic 8 pcs.	Plastic 8 pcs.	Stainless 8 pcs.
<b>Reinforcing frame</b>	Powder coated	Powder coated	Powder coated	Stainless
<b>Cassette material</b>	Stainless rod Ø2 and Ø5 mm	Stainless rod Ø2 and Ø5 mm	Stainless rod Ø2 and Ø5 mm	Stainless rod Ø3 and Ø6 mm
<b>Drum rim</b>	Powder coated	Powder coated	Powder coated	Stainless
<b>Drum height</b>	735 mm	735 mm	735 mm	780 mm

## ADDITIONAL INFORMATION

<b>Other</b>	For self-assembly (shipped in carton) It is a possibility to order extractor for Hungarian frame	Shipped on pallet	Shipped on pallet	Shipped on pallet
--------------	--	-------------------	-------------------	-------------------

\* Classic line extractors: controller can be exchanged for advanced automatic controller (HE-03) for an extra charge



WARRANTY DETAILS,  
PAGE 254-255.

**dimensions of frames:**  
Dadant — 435x300 mm  
Dadant 1/2 — 435x159 mm  
2 frame — 435x170 mm

**dimensions of cassettes:**  
425x355 mm



# 6-CASSETTE DADANT



	<b>BASIC</b> line	<b>MINIMA</b> line	<b>OPTIMA</b> line	<b>CLASSIC</b> line	<b>PREMIUM</b> line
<b>ID</b>	<b>W210KN_B</b>	<b>W2014MKN</b>	<b>W2014KN</b>	<b>W20540</b> <b>W205400</b>	<b>W205400_P</b>
<b>Name</b>	Honey extractor Ø900mm, 6-cassette, electric drive	6-cassette honey extractor Ø1000 mm electric	6-cassette honey extractor Ø1000 mm electric	6-cassette honey extrac- tor Ø1000 mm electric	6-cassette honey extractor Ø1000 mm electric
<b>TECHNICAL PARAMETERS</b>					
<b>Type of frame</b>	6×Dadant, 12×Dadant ½	6×Dadant, 12×Dadant 1/2	6×Dadant, 12×Dadant 1/2	6×Dadant, 12×Dadant 1/2	6×Dadant, 12×Dadant 1/2
<b>Drum diameter</b>	Ø900 mm	Ø1000 mm	Ø1000 mm	Ø1000 mm	Ø1000 mm
<b>Drive system</b>	Electric bottom	Electric bottom	Electric bottom	Electric bottom	Electric bottom
<b>Power supply</b>	230V	12V	12V/230V	230V	230V
<b>Controller</b>	HE-01V	HE-01U	HE-01V	HES-02*   HE-02H*	HE-03
<b>Motor</b>	Belt drive 12V/150W	Belt drive 24V/350W	Belt drive 24V/350W	Motoreducer 0,37kW	Motoreducer 0,55kW
<b>DRUM AND BASKET CONSTRUCTION</b>					
<b>Thickness</b>	0,6 mm	drum 0,6 mm bottom 0,8 mm	drum 0,6 mm bottom 0,8 mm	drum 0,6 mm bottom 0,8 mm	0,8 mm
<b>Honey gate</b>	Stainless 6/4"	2×plastic 2"	2×stainless 2"	2×stainless 2"	2×stainless 2"
<b>Top bar</b>	Powder coated plate	Flat bar 60x10 mm powder coated	Flat bar 60x10 mm powder coated	Flat bar 60x10 mm powder coated	Flat bar 60x10 mm stainless
<b>Cover</b>	4 mm acrylic glass	4 mm acrylic glass	4 mm acrylic glass	4 mm acrylic glass	8 mm acrylic glass
<b>Legs</b>	Two-piece, unassem- bled, powder coated	Powder coated 40x27 mm	Powder coated 50x30 mm	Powder coated 60x40 mm	Stainless 60x40 mm
<b>Hinges</b>	Plastic 4 pcs.	Plastic 8 pcs.	Plastic 8 pcs.	Plastic 8 pcs.	Stainless 8 pcs.
<b>Reinforcing frame</b>	Powder coated	Powder coated	Powder coated	Powder coated	Stainless
<b>Cassette material</b>	Stainless rod Ø2 and Ø5 mm	Stainless rod Ø2 and Ø5 mm	Stainless rod Ø2 and Ø5 mm	Stainless rod Ø2 and Ø5 mm	Stainless rod Ø3 and Ø6 mm
<b>Drum rim</b>	Powder coated	Powder coated	Powder coated	Powder coated	Stainless
<b>Drum height</b>	735 mm	735 mm	735 mm	735 mm	780 mm
<b>ADDITIONAL INFORMATION</b>					
<b>Other</b>	For self-assembly (shipped in carton)	Shipped on pallet	Shipped on pallet	Shipped on pallet	Shipped on pallet

\* Classic line extractors: controller can be exchanged for advanced automatic controller (HE-03) for an extra charge



WARRANTY DETAILS,  
PAGE 254-255.

#### dimensions of frames:

Dadant — 435x300 mm  
Dadant 1/2 — 435x159 mm

#### dimensions of cassettes:

425x340 mm  
425x325 mm (**W210KN\_B**)

# 8-CASSETTE DADANT



## MINIMA line

## OPTIMA line

## CLASSIC line

ID	W2015MKN	W2015KN	W20560	W205600
Name	8-cassette honey extractor Ø1000 mm, electric drive	8-cassette honey extractor Ø1000 mm, electric drive	8-cassette honey extractor Ø1000 mm, electric drive, semi-automatic/automatic	

### TECHNICAL PARAMETERS

Type of frame	8×Dadant, 16×Dadant 1/2	8×Dadant, 16×Dadant 1/2	8×Dadant, 16×Dadant 1/2	
Drum diameter	Ø1000 mm	Ø1000 mm	Ø1000 mm	
Drive system	Electric bottom	Electric bottom	Electric bottom	
Power supply	12V	12V/230V	230V	
Controller	HE-01U	HE-01V	HES-02*	HE-02H*
Motor	Belt drive 24V/350W	Belt drive 24V/350W	Motoreducer 0,55kW	

### DRUM AND BASKET CONSTRUCTION

Thickness	drum 0,6 mm bottom 0,8 mm	drum 0,6 mm bottom 0,8 mm	drum 0,6 mm bottom 0,8 mm	
Honey gate	2×plastic 2"	2×stainless 2"	2×stainless 2"	
Top bar	Flat bar 60x10 mm powder coated	Flat bar 60x10 mm powder coated	Flat bar 60x10 mm powder coated	
Cover	4 mm acrylic glass	4 mm acrylic glass	4 mm acrylic glass	
Legs	Powder coated 40x27 mm	Powder coated 50x30 mm	Powder coated 60x40 mm	
Hinges	Plastic 8 pcs.	Plastic 8 pcs.	Plastic 8 pcs.	
Reinforcing frame	Powder coated	Powder coated	Powder coated	
Cassette material	Stainless rod Ø2 and Ø5 mm	Stainless rod Ø2 and Ø5 mm	Stainless rod Ø2 and Ø5 mm	
Drum rim	Powder coated	Powder coated	Powder coated	
Drum height	735 mm	735 mm	735 mm	

### ADDITIONAL INFORMATION

Other	Shipped on pallet The cassettes overlap	Shipped on pallet The cassettes overlap	Shipped on pallet The cassettes overlap	
-------	--	--	--	--

\* Classic line extractors: controller can be exchanged for advanced automatic controller (HE-03) for an extra charge



WARRANTY DETAILS,  
PAGE 254-255.

**dimensions of frames:**  
Dadant — 435x300 mm  
Dadant 1/2 — 435x159 mm

**dimensions of cassettes:**  
425x340 mm

# 8-CASSETTE DADANT



## CLASSIC line

## PREMIUM line

ID	W20550	W205500	W205500_P
Name	8-cassette honey extractor Ø1200 mm, electric drive, semi-automatic/automatic		8-cassette honey extractor Ø1200 mm electric drive

### TECHNICAL PARAMETERS

Type of frame	8×Dadant, 16×Dadant 1/2	8×Dadant, 16×Dadant 1/2	
Drum diameter	Ø1200 mm	Ø1200 mm	
Drive system	Electric bottom	Electric bottom	
Power supply	230V	230V	
Controller	HES-02*	HE-02H*	HE-03
Motor	Motoreducer 0,55kW	Motoreducer 0,75kW	

### DRUM AND BASKET CONSTRUCTION

Thickness	drum 0,6 mm bottom 0,8 mm	0,8 mm
Honey gate	2×stainless 2"	2×stainless 2"
Top bar	Flat bar 60x10 mm powder coated	Flat bar 60x10 mm stainless
Cover	5 mm acrylic glass	8 mm acrylic glass
Legs	Powder coated 60x40 mm	Stainless 60x40 mm
Hinges	Plastic 8 pcs.	Stainless 8 pcs.
Reinforcing frame	Powder coated	Stainless
Cassette material	Stainless rod Ø2 and Ø5 mm	Stainless rod Ø3 and Ø6 mm
Drum rim	Powder coated	Stainless
Drum height	730 mm	780 mm

### ADDITIONAL INFORMATION

Other	Shipped on pallet	Shipped on pallet
-------	-------------------	-------------------

\* Classic line extractors: controller can be exchanged for advanced automatic controller (HE-03) for an extra charge



WARRANTY DETAILS,  
PAGE 254-255.

**dimensions of frames:**  
Dadant — 435x300 mm  
Dadant 1/2 — 435x159 mm

**dimensions of cassettes:**  
425x340 mm

# 12-CASSETTE DADANT



## CLASSIC line

## PREMIUM line

ID	W2057B	W20570B	W20570B_P
Name	12-cassette honey extractor Ø1200 mm, electric drive, semi-automatic/automatic		12-cassette honey extractor Ø1200 mm, electric drive

### TECHNICAL PARAMETERS

Type of frame	12×Dadant, 24×Dadant 1/2	12×Dadant, 24×Dadant 1/2	
Drum diameter	Ø1200 mm	Ø1200 mm	
Drive system	Electric bottom	Electric bottom	
Power supply	230V	230V	
Controller	HES-02*	HE-02H*	HE-03
Motor	Motoreducer 0,75kW	Motoreducer 1,1kW	

### DRUM AND BASKET CONSTRUCTION

Drum thickness	0,8 mm	0,8 mm
Honey gate	2×stainless 2"	2×stainless 2"
Top bar	Flat bar 60x10 mm powder coated	Flat bar 60x10 mm stainless
Cover	5 mm acrylic glass	8 mm acrylic glass
Legs	Powder coated 60x40 mm	Stainless 60x40 mm
Hinges	Plastic 8 pcs.	Stainless 8 pcs.
Reinforcing frame	Powder coated	Stainless
Cassette material	Stainless rod Ø2 and Ø6 mm	Stainless rod Ø3 and Ø6 mm
Drum rim	Powder coated	Stainless
Drum height	785 mm	780 mm

### ADDITIONAL INFORMATION

Other	Basket with partitions, shipped on pallet	Basket with partitions, shipped on pallet
-------	---	---

\* Classic line extractors: controller can be exchanged for advanced automatic controller (HE-03) for an extra charge



WARRANTY DETAILS,  
PAGE 254-255.

**dimensions of frames:**  
Dadant — 435x300 mm  
Dadant 1/2 — 435x159 mm

**dimensions of cassettes:**  
425x340 mm

# 16-CASSETTE DADANT



## CLASSIC line

## PREMIUM line

ID	W20300B	W20300B	W20300B_P
Name	16-cassette honey extractor Ø1200 mm, electric drive, semi-automatic/automatic		16-cassette honey extractor Ø1200 mm, electric drive

### TECHNICAL PARAMETERS

Type of frame	16×Dadant, 32×Dadant 1/2	16×Dadant, 32×Dadant 1/2	
Drum diameter	Ø1200 mm	Ø1200 mm	
Drive system	Electric bottom	Electric bottom	
Power supply	230V	230V	
Controller	HES-02*	HE-02H*	HE-03
Motor	Motoreducer 1,5kW	Motoreducer 1,5kW	

### DRUM AND BASKET CONSTRUCTION

Drum thickness	0,8 mm	0,8 mm
Honey gate	2×stainless 2"	2×stainless 2"
Top bar	Flat bar 60x10 mm powder coated	Flat bar 60x10 mm stainless
Cover	5 mm acrylic glass	8 mm acrylic glass
Legs	Powder coated 60x40 mm	Stainless 60x40 mm
Hinges	Plastic 8 pcs.	Stainless 8 pcs.
Reinforcing frame	Powder coated	Stainless
Cassette material	Stainless rod Ø2 and Ø6 mm	Stainless rod Ø3 and Ø6 mm
Drum rim	Powder coated	Stainless
Drum height	785 mm	780 mm

### ADDITIONAL INFORMATION

Other	Basket with partitions, shipped on pallet	Basket with partitions, shipped on pallet
-------	---	---

\* Classic line extractors: controller can be exchanged for advanced automatic controller (HE-03) for an extra charge



WARRANTY DETAILS,  
PAGE 254-255.

**dimensions of frames:**  
Dadant — 435x300 mm  
Dadant 1/2 — 435x159 mm

**dimensions of cassettes:**  
425x325 mm

# 4-CASSETTE LANGSTROTH



## BASIC line

## OPTIMA line

## CLASSIC line

## PREMIUM line

ID	W2013000KN_B	W2013000KN	W2013000KFMR W201300AMR	W201300AMR_P
Name	Honey extractor Ø720mm, 4-cassette, electric drive	4-cassette honey extractor Ø720 mm, electric drive	4-cassette honey extractor Ø720 mm, electric drive, semi-automatic/automatic	4-cassette honey extractor Ø720 mm, electric drive
TECHNICAL PARAMETERS				
Type of frame	4×Langstroth	4×Langstroth	4×Langstroth	4×Langstroth
Drum diameter	Ø720 mm	Ø720 mm	Ø720 mm	Ø720 mm
Drive system	Electric bottom	Electric bottom	Electric bottom	Electric bottom
Power supply	230V	12V/230V	230V	230V
Controller	HE-01V	HE-01V	HES-02* HE-02H*	HE-03
Motor	Belt drive 12V/150W	Belt drive 24V/250W	Motoreducer 0,37kW	Motoreducer 0,55kW
DRUM AND BASKET CONSTRUCTION				
Drum thickness	0,6 mm	0,6 mm	0,6 mm	0,8 mm
Honey gate	Stainless 6/4"	Stainless 6/4"	Stainless 6/4"	Stainless 6/4"
Top bar	Powder coated plate	Powder coated plate	Powder coated plate	Flat bar 60x10 mm stainless
Cover	4 mm acrylic glass	4 mm acrylic glass	4 mm acrylic glass	8 mm acrylic glass
Legs	Two-piece, unassembled, powder coated	Powder coated 50x30 mm	Powder coated 50x30 mm	Stainless 50x30 mm
Hinges	Plastic 4 pcs.	Plastic 4 pcs.	Plastic 4 pcs.	Stainless 8 pcs.
Reinforcing frame	Powder coated	Powder coated	Powder coated	Stainless
Cassette material	Stainless rod Ø2 and Ø5 mm	Stainless rod Ø2 and Ø5 mm	Stainless rod Ø2 and Ø5 mm	Stainless rod Ø3 and Ø6 mm
Drum rim	Powder coated	Powder coated	Powder coated	Stainless
Drum height	740 mm	740 mm	740 mm	780 mm
ADDITIONAL INFORMATION				
Other	For self-assembly (shipped in carton)	Shipped on pallet	Shipped on pallet	Shipped on pallet

\* Classic line extractors: controller can be exchanged for advanced automatic controller (HE-03) for an extra charge



WARRANTY DETAILS,  
PAGE 254-255.

dimensions of frames:  
Langstroth - 450x232 mm

dimensions of cassettes:  
Langstroth - 440x250 mm



# 6-CASSETTE LANGSTROTH



## BASIC line

## OPTIMA line

## CLASSIC line

## PREMIUM line

ID	W2013KAN_B	W2013KAN	W20501G W205001G	W205001_P
Name	Honey extractor Ø800mm, 6-cassette, electric drive	6-cassette honey extractor Ø800 mm electric	6-cassette honey extractor Ø800 mm electric, semi-automatic/automatic	6-cassette honey extractor Ø800 mm electric

### TECHNICAL PARAMETERS

Type of frame	6×Langstroth	6×Langstroth	6×Langstroth	6×Langstroth
Drum diameter	Ø800 mm	Ø800 mm	Ø800 mm	Ø800 mm
Drive system	Electric bottom	Electric bottom	Electric top	Electric bottom
Power supply	230V	12V/230V	230V	230V
Controller	HE-01V	HE-01V	HES-02* HE-02H*	HE-03
Motor	Belt drive 12V/150W	Belt drive 24V/350W	Motoreducer 0,37kW	Motoreducer 0,55kW

### DRUM AND BASKET CONSTRUCTION

Drum thickness	0,6 mm	0,6 mm	0,6 mm	0,8 mm
Honey gate	Stainless 6/4"	Stainless 6/4"	Stainless 6/4"	Stainless 6/4"
Top bar	Powder coated plate	Powder coated plate	Flat bar 100x10 mm powder coated	Flat bar 60x10 mm stainless
Cover	4 mm acrylic glass	4 mm acrylic glass	4 mm acrylic glass	8 mm acrylic glass
Legs	Two-piece, unassembled, powder coated	Powder coated 50x30 mm	Powder coated 50x30 mm	Stainless 50x30 mm
Hinges	Plastic 4 pcs.	Plastic 8 pcs.	Plastic 4 pcs.	Stainless 8 pcs.
Reinforcing frame	Powder coated	Powder coated	Powder coated	Stainless
Cassette material	Stainless rod Ø2 and Ø5 mm	Stainless rod Ø2 and Ø5 mm	Stainless rod Ø2 and Ø5 mm	Stainless rod Ø3 and Ø6 mm
Drum rim	Powder coated	Powder coated	Powder coated	Stainless
Drum height	740 mm	740 mm	740 mm	780 mm

### ADDITIONAL INFORMATION

Other	For self-assembly (shipped in carton)	Shipped on pallet	Shipped on pallet	Shipped on pallet
-------	---------------------------------------	-------------------	-------------------	-------------------

\* Classic line extractors: controller can be exchanged for advanced automatic controller (HE-03) for an extra charge



WARRANTY DETAILS,  
PAGE 254-255.

dimensions of frames:  
Langstroth — 450x232 mm

dimensions of cassettes:  
440x250 mm

# 8-CASSETTE LANGSTROTH



**MINIMA**  
line

**OPTIMA**  
line

**CLASSIC**  
line

**PREMIUM**  
line

<b>ID</b>	<b>W2015MKN_LN</b>	<b>W201601KN</b>	<b>W20161</b> <b>W201601</b>	<b>W201601_P</b>
<b>Name</b>	8-cassette honey extractor Ø1000 mm electric	8-cassette honey extractor Ø1000 mm, electric drive	8-cassette honey extractor Ø1000 mm, electric drive, semi-automatic/automatic	8-cassette honey extractor Ø1000 mm, electric drive

### TECHNICAL PARAMETERS

<b>Type of frame</b>	8×Langstroth	8×Langstroth	8×Langstroth	8×Langstroth
<b>Drum diameter</b>	Ø1000 mm	Ø1000 mm	Ø1000 mm	Ø1000 mm
<b>Drive system</b>	Electric bottom	Electric bottom	Electric bottom	Electric bottom
<b>Power supply</b>	12V	12V/230V	230V	230V
<b>Controller</b>	HE-01U	HE-01V	HES-02*    HE-02H*	HE-03
<b>Motor</b>	Belt drive 24V/350W	Belt drive 24V/350W	Motoreducer 0,55kW	Motoreducer 0,75kW

### DRUM AND BASKET CONSTRUCTION

<b>Thickness</b>	drum 0,6 mm bottom 0,8 mm	drum 0,6 mm bottom 0,8 mm	drum 0,6 mm bottom 0,8 mm	0,8 mm
<b>Honey gate</b>	2×plastic 2"	2×stainless 2"	2×stainless 2"	2×stainless 2"
<b>Top bar</b>	Flat bar 60x10 mm powder coated	Flat bar 60x10 mm powder coated	Flat bar 60x10 mm powder coated	Flat bar 60x10 mm stainless
<b>Cover</b>	4 mm acrylic glass	4 mm acrylic glass	4 mm acrylic glass	8 mm acrylic glass
<b>Legs</b>	Powder coated 40x27 mm	Powder coated 50x30 mm	Power coated 60x40 mm	Stainless 60x40 mm
<b>Hinges</b>	Plastic 8 pcs.	Plastic 8 pcs.	Plastic 8 pcs.	Stainless 8 pcs.
<b>Reinforcing frame</b>	Powder coated	Powder coated	Powder coated	Stainless
<b>Cassette material</b>	Stainless rod Ø2 and Ø5 mm	Stainless rod Ø2 and Ø5 mm	Stainless rod Ø2 and Ø5 mm	Stainless rod Ø3 and Ø6 mm
<b>Drum rim</b>	Powder coated	Powder coated	Powder coated	Stainless
<b>Drum height</b>	735 mm	735 mm	735 mm	780 mm

### ADDITIONAL INFORMATION

<b>Other</b>	Shipped on pallet	Shipped on pallet	Shipped on pallet	Shipped on pallet
--------------	-------------------	-------------------	-------------------	-------------------

\* Classic line extractors: controller can be exchanged for advanced automatic controller (HE-03) for an extra charge



WARRANTY DETAILS,  
PAGE 254-255.

**dimensions of frames:**  
Langstroth — 450x232 mm

**dimensions of cassettes:**  
440x250 mm

# 12-CASSETTE LANGSTROTH



## CLASSIC line

## PREMIUM line

<b>ID</b>	<b>W205301B</b>	<b>W2053001B</b>	<b>W2053001B_P</b>
<b>Name</b>	12-cassette honey extractor Ø1000 mm, electric drive, semi-automatic/automatic		12-cassette honey extractor Ø1000 mm, electric drive

### TECHNICAL PARAMETERS

<b>Type of frame</b>	12×Langstroth	12×Langstroth	
<b>Drum diameter</b>	Ø1000 mm	Ø1000 mm	
<b>Drive system</b>	Electric bottom	Electric bottom	
<b>Power supply</b>	230V	230V	
<b>Controller</b>	HES-02*	HE-02H*	HE-03
<b>Motor</b>	Motoreducer 0,75kW		Motoreducer 0,75kW

### DRUM AND BASKET CONSTRUCTION

<b>Drum thickness</b>	0,8 mm	0,8 mm
<b>Honey gate</b>	2×stainless 2"	2×stainless 2"
<b>Top bar</b>	Flat bar 60x10 mm powder coated	Flat bar 60x10 mm stainless
<b>Cover</b>	4 mm acrylic glass	8 mm acrylic glass
<b>Legs</b>	Powder coated 60x40 mm	Stainless 60x40 mm
<b>Hinges</b>	Plastic 8 pcs.	Stainless 8 pcs.
<b>Reinforcing frame</b>	Powder coated	Stainless
<b>Cassette material</b>	Stainless rod Ø2 and Ø6 mm	Stainless rod Ø3 and Ø6 mm
<b>Drum rim</b>	Powder coated	Stainless
<b>Drum height</b>	785 mm	780 mm

### ADDITIONAL INFORMATION

<b>Other</b>	Basket with partitions, shipped on pallet	Basket with partitions, shipped on pallet
--------------	---	---

\* Classic line extractors: controller can be exchanged for advanced automatic controller (HE-03) for an extra charge



WARRANTY DETAILS,  
PAGE 254-255.

**dimensions of frames:**  
Langstroth — 450x232 mm

**dimensions of cassettes:**  
440x250 mm

# 16-CASSETTE LANGSTROTH



## CLASSIC line

## PREMIUM line

<b>ID</b>	<b>W205201B</b>	<b>W2052001B</b>	<b>W2052001B_P</b>
<b>Name</b>	16-cassette honey extractor Ø1200 mm, electric drive, semi-automatic/automatic		16-cassette honey extractor Ø1200 mm, electric drive

### TECHNICAL PARAMETERS

<b>Type of frame</b>	16×Langstroth	16×Langstroth	
<b>Drum diameter</b>	Ø1200 mm	Ø1200 mm	
<b>Drive system</b>	Electric bottom	Electric bottom	
<b>Power supply</b>	230V	230V	
<b>Controller</b>	HES-02*	HE-02H*	HE-03
<b>Motor</b>	Motoreducer 1,5kW	Motoreducer 1,5kW	

### DRUM AND BASKET CONSTRUCTION

<b>Drum thickness</b>	0,8 mm	0,8 mm
<b>Honey gate</b>	2×stainless 2"	2×stainless 2"
<b>Top bar</b>	Flat bar 60x10 mm powder coated	Flat bar 60x10 mm stainless
<b>Cover</b>	5 mm acrylic glass	8 mm acrylic glass
<b>Legs</b>	Powder coated 60x40 mm	Stainless 60x40 mm
<b>Hinges</b>	Plastic 8 pcs.	Stainless 8 pcs.
<b>Reinforcing frame</b>	Powder coated	Stainless
<b>Cassette material</b>	Stainless rod Ø2 and Ø6 mm	Stainless rod Ø3 and Ø6 mm
<b>Drum rim</b>	Powder coated	Stainless
<b>Drum height</b>	785 mm	780 mm

### ADDITIONAL INFORMATION

<b>Other</b>	Basket with partitions, shipped on pallet	Basket with partitions, shipped on pallet
--------------	---	---

\* Classic line extractors: controller can be exchanged for advanced automatic controller (HE-03) for an extra charge



WARRANTY DETAILS,  
PAGE 254-255.

**dimensions of frames:**  
Langstroth — 450x232 mm

**dimensions of cassettes:**  
440x250 mm

# 20-CASSETTE LANGSTROTH



## CLASSIC line

## PREMIUM line

ID	W209901B	W2099001B	W2099001B_P
Name	20-cassette honey extractors Ø1200 mm electric, semi-automatic/automatic		20-cassette honey extractors Ø1200 mm electric drive

### TECHNICAL PARAMETERS

Type of frame	20×Langstroth	20×Langstroth	
Drum diameter	Ø1200 mm	Ø1200 mm	
Drive system	Electric bottom	Electric bottom	
Power supply	230V	230V	
Controller	HES-02*	HE-02H*	HE-03
Motor	Motoreducer 1,5kW	Motoreducer 1,5kW	

### DRUM AND BASKET CONSTRUCTION

Drum thickness	0,8 mm	0,8 mm
Honey gate	2×stainless 2"	2×stainless 2"
Top bar	Flat bar 60x10 mm powder coated	Flat bar 60x10 mm stainless
Cover	5 mm acrylic glass	8 mm acrylic glass
Legs	Powder coated 60x40 mm	Stainless 60x40 mm
Hinges	Plastic 8 pcs.	Stainless 8 pcs.
Reinforcing frame	Powder coated	Stainless
Cassette material	Stainless rod Ø2 and Ø6 mm	Stainless rod Ø3 and Ø6 mm
Drum rim	Powder coated	Stainless
Drum height	785 mm	780 mm

### ADDITIONAL INFORMATION

Other	Basket with partitions, shipped on pallet	Basket with partitions, shipped on pallet
-------	---	---

\* Classic line extractors: controller can be exchanged for advanced automatic controller (HE-03) for an extra charge



WARRANTY DETAILS,  
PAGE 254-255.

dimensions of frames:  
Langstroth — 450x232 mm

dimensions of cassettes:  
440x250 mm

# 4-CASSETTE DEUTSCH NORMAL



	<b>BASIC</b> line	<b>OPTIMA</b> line	<b>CLASSIC</b> line	<b>PREMIUM</b> line
<b>ID</b>	<b>W20130KN_DNM_B</b>	<b>W20130KN_DNM</b>	<b>W20130KFMR_DNM</b> <b>W20130AMR_DNM</b>	<b>W20130AMR_P_DNM</b>
<b>Name</b>	Honey extractor Ø720mm, 4-cassette, electric drive	4-cassette honey extractor Ø720 mm, electric drive	4-cassette honey extractors Ø720 mm, electric drive, semi-automatic/automatic	4-cassette honey extractor Ø720 mm, electric drive
<b>TECHNICAL PARAMETERS</b>				
<b>Type of frame</b>	4×Deutsch Normal	4×Deutsch Normal	4×Deutsch Normal	4×Deutsch Normal
<b>Drum diameter</b>	Ø720 mm	Ø720 mm	Ø720 mm	Ø720 mm
<b>Drive system</b>	Electric bottom	Electric bottom	Electric bottom	Electric bottom
<b>Power supply</b>	230V	12V/230V	230V	230V
<b>Controller</b>	HE-01V	HE-01V	HES-02*      HE-02H*	HE-03
<b>Motor</b>	Belt drive 12V/150W	Belt drive 24V/250W	Motoreducer 0,37kW	Motoreducer 0,55kW
<b>DRUM AND BASKET CONSTRUCTION</b>				
<b>Drum thickness</b>	0,6 mm	0,6 mm	0,6 mm	0,8 mm
<b>Honey gate</b>	Stainless 6/4"	Stainless 6/4"	Stainless 6/4"	Stainless 6/4"
<b>Top bar</b>	Powder coated plate	Powder coated plate	Powder coated plate	Flat bar 60x10 mm stain- less
<b>Cover</b>	4 mm acrylic glass	4 mm acrylic glass	4 mm acrylic glass	8 mm acrylic glass
<b>Legs</b>	Two-piece, unassem- bled, powder coated	Powder coated 50x30 mm	Powder coated 50x30 mm	Stainless 50x30 mm
<b>Hinges</b>	Plastic 4 pcs.	Plastic 4 pcs.	Plastic 4 pcs.	Stainless 8 pcs.
<b>Reinforcing frame</b>	Powder coated	Powder coated	Powder coated	Stainless
<b>Cassette material</b>	Stainless rod Ø2 and Ø5 mm	Stainless rod Ø2 and Ø5 mm	Stainless rod Ø2 and Ø5 mm	Stainless rod Ø3 and Ø6 mm
<b>Drum rim</b>	Powder coated	Powder coated	Powder coated	Stainless
<b>Drum height</b>	645 mm	645 mm	645 mm	730 mm
<b>ADDITIONAL INFORMATION</b>				
<b>Other</b>	For self-assembly (shipped in carton)	Shipped on pallet	Shipped on pallet	Shipped on pallet

\* Classic line extractors: controller can be exchanged for advanced automatic controller (HE-03) for an extra charge



WARRANTY DETAILS,  
PAGE 254-255.

**dimensions of frames:**  
Deutsch Normal – 370x220 mm

**dimensions of cassettes:**  
360x250 mm

# 6-CASSETTE DEUTSCH NORMAL



**BASIC**  
line

**OPTIMA**  
line

**CLASSIC**  
line

**PREMIUM**  
line

ID	W2013KBN_DNM_B	W2013KBN_DNM	W20500G_DNM	W205000G_DNM	W205000_P_DNM
<b>Name</b>	Honey extractor Ø800mm, 6-cassette, electric drive	6-cassette honey extractor Ø800 mm, electric drive	6-cassette honey extractor Ø800 mm, electric drive, semi-automatic/automatic		6-cassette honey extractor Ø800 mm, electric drive

## TECHNICAL PARAMETERS

<b>Type of frame</b>	6×Deutsch Normal	6×Deutsch Normal	6×Deutsch Normal	6×Deutsch Normal	6×Deutsch Normal
<b>Drum diameter</b>	Ø800 mm	Ø800 mm	Ø800 mm	Ø800 mm	Ø800 mm
<b>Drive system</b>	Electric bottom	Electric bottom	Electric top		Electric bottom
<b>Power supply</b>	230V	12V/230V	230V		230V
<b>Controller</b>	HE-01V	HE-01V	HES-02*	HE-02H*	HE-03
<b>Motor</b>	Belt drive 12V/150W	Belt drive 24V/350W	Motoreducer 0,37kW		Motoreducer 0,55kW

## DRUM AND BASKET CONSTRUCTION

<b>Drum thickness</b>	0,6 mm	0,6 mm	0,6 mm		0,8 mm
<b>Honey gate</b>	Stainless 6/4"	Stainless 6/4"	Stainless 6/4"		Stainless 6/4"
<b>Top bar</b>	Powder coated plate	Powder coated plate	Flat bar 100x10 mm Powder coated		Flat bar 60x10 mm stainless
<b>Cover</b>	4 mm acrylic glass	4 mm acrylic glass	4 mm acrylic glass		8 mm acrylic glass
<b>Legs</b>	Two-piece, unassembled, powder coated	Powder coated 50x30 mm	Powder coated 50x30 mm		Stainless 50x30 mm
<b>Hinges</b>	Plastic 4 pcs.	Plastic 8 pcs.	Plastic 4 pcs.		Stainless 8 pcs.
<b>Reinforcing frame</b>	Powder coated	Powder coated	Powder coated		Stainless
<b>Cassette material</b>	Stainless rod Ø2 and Ø5 mm	Stainless rod Ø2 and Ø5 mm	Stainless rod Ø2 and Ø5 mm		Stainless rod Ø3 and Ø6 mm
<b>Drum rim</b>	Powder coated	Powder coated	Powder coated		Stainless
<b>Drum height</b>	645 mm	645 mm	645 mm		730 mm

## ADDITIONAL INFORMATION

<b>Other</b>	For self-assembly (shipped in carton)	Shipped on pallet	Shipped on pallet		Shipped on pallet
--------------	--	-------------------	-------------------	--	-------------------

\* Classic line extractors: controller can be exchanged for advanced automatic controller (HE-03) for an extra charge



WARRANTY DETAILS,  
PAGE 254-255.

**dimensions of frames:**  
Deutsch Normal – 370x220 mm

**dimensions of cassettes:**  
360x250 mm

# 8-CASSETTE DEUTSCH NORMAL



## CLASSIC line

## PREMIUM line

ID	W20160_DNM	W201600_DNM	W201600_P_DNM
Name	8-cassette honey extractor Ø1000 mm, electric drive, semi-automatic/automatic		8-cassette honey extractor Ø1000 mm, electric drive

### TECHNICAL PARAMETERS

Type of frame	8×Deutsch Normal	8×Deutsch Normal	
Drum diameter	Ø1000 mm	Ø1000 mm	
Drive system	Electric bottom	Electric bottom	
Power supply	230V	230V	
Controller	HES-02*	HE-02H*	HE-03
Motor	Motoreducer 0,55kW	Motoreducer 0,75kW	

### DRUM AND BASKET CONSTRUCTION

Thickness	drum 0,6 mm bottom 0,8 mm	0,8 mm
Honey gate	2×stainless 2"	2×stainless 2"
Top bar	Flat bar 60x10 mm powder coated	Flat bar 60x10 mm stainless
Cover	4 mm acrylic glass	8 mm acrylic glass
Legs	Powder coated 60x40 mm	Stainless 60x40 mm
Hinges	Plastic 8 pcs.	Stainless 8 pcs.
Reinforcing frame	Powder coated	Stainless
Cassette material	Stainless rod Ø2 and Ø5 mm	Stainless rod Ø3 and Ø6 mm
Drum rim	Powder coated	Stainless
Drum height	685 mm	730 mm

### ADDITIONAL INFORMATION

Other	Shipped on pallet	Shipped on pallet
-------	-------------------	-------------------

\* Classic line extractors: controller can be exchanged for advanced automatic controller (HE-03) for an extra charge



WARRANTY DETAILS,  
PAGE 254-255.

dimensions of frames:  
Deutsch Normal – 370x220 mm

dimensions of cassettes:  
360x250 mm

# 12-CASSETTE DEUTSCH NORMAL



## CLASSIC line

## PREMIUM line

<b>ID</b>	<b>W20530B_DNM</b>	<b>W205300B_DNM</b>	<b>W205300B_P_DNM</b>
<b>Name</b>	12-cassette honey extractor Ø1000 mm, electric drive, semi-automatic/automatic		12-cassette honey extractor Ø1000 mm, electric drive

### TECHNICAL PARAMETERS

<b>Type of frame</b>	12×Deutsch Normal	12×Deutsch Normal
<b>Drum diameter</b>	Ø1000 mm	Ø1000 mm
<b>Drive system</b>	Electric bottom	Electric bottom
<b>Power supply</b>	230V	230V
<b>Controller</b>	HES-02*      HE-02H*	HE-03
<b>Motor</b>	Motoreducer 0,75kW	Motoreducer 0,75kW

### DRUM AND BASKET CONSTRUCTION

<b>Thickness</b>	drum 0,6 mm bottom 0,8 mm	0,8 mm
<b>Honey gate</b>	2×stainless 2"	2×stainless 2"
<b>Top bar</b>	Flat bar 60x10 mm powder coated	Flat bar 60x10 mm stainless
<b>Cover</b>	4 mm acrylic glass	8 mm acrylic glass
<b>Legs</b>	Powder coated 60x40 mm	Stainless 60x40 mm
<b>Hinges</b>	Plastic 8 pcs.	Stainless 8 pcs.
<b>Reinforcing frame</b>	Powder coated	Stainless
<b>Cassette material</b>	Stainless rod Ø2 and Ø6 mm	Stainless rod Ø3 and Ø6 mm
<b>Drum rim</b>	Powder coated	Stainless
<b>Drum height</b>	735 mm	730 mm

### ADDITIONAL INFORMATION

<b>Other</b>	Basket with partitions, shipped on pallet	Basket with partitions, shipped on pallet
--------------	---	---

\* Classic line extractors: controller can be exchanged for advanced automatic controller (HE-03) for an extra charge



WARRANTY DETAILS,  
PAGE 254-255.

**dimensions of frames:**  
Deutsch Normal – 370x220 mm

**dimensions of cassettes:**  
360x250 mm

# 16-CASSETTE DEUTSCH NORMAL



## CLASSIC line

## PREMIUM line

<b>ID</b>	<b>W20520B_DNM</b>	<b>W205200B_DNM</b>	<b>W205200B_P_DNM</b>
<b>Name</b>	16-cassette honey extractors Ø1200 mm electric, semi-automatic/automatic		16-cassette honey extractors Ø1200 mm electric drive

### TECHNICAL PARAMETERS

<b>Type of frame</b>	16×Deutsch Normal	16×Deutsch Normal	
<b>Drum diameter</b>	Ø1200 mm	Ø1200 mm	
<b>Drive system</b>	Electric bottom	Electric bottom	
<b>Power supply</b>	230V	230V	
<b>Controller</b>	HES-02*	HE-02H*	HE-03
<b>Motor</b>	Motoreducer 1,5kW	Motoreducer 1,5kW	

### DRUM AND BASKET CONSTRUCTION

<b>Thickness</b>	drum 0,6 mm bottom 0,8 mm	0,8 mm
<b>Honey gate</b>	2×stainless 2"	2×stainless 2"
<b>Top bar</b>	Flat bar 60x10 mm powder coated	Flat bar 60x10 mm stainless
<b>Cover</b>	5 mm acrylic glass	8 mm acrylic glass
<b>Legs</b>	Powder coated 60x40 mm	Stainless 60x40 mm
<b>Hinges</b>	Plastic 8 pcs.	Stainless 8 pcs.
<b>Reinforcing frame</b>	Powder coated	Stainless
<b>Cassette material</b>	Stainless rod Ø2 and Ø6 mm	Stainless rod Ø3 and Ø6 mm
<b>Drum rim</b>	Powder coated	Stainless
<b>Drum height</b>	730 mm	730 mm

### ADDITIONAL INFORMATION

<b>Other</b>	Basket with partitions, shipped on pallet	Basket with partitions, shipped on pallet
--------------	---	---

\* Classic line extractors: controller can be exchanged for advanced automatic controller (HE-03) for an extra charge



WARRANTY DETAILS,  
PAGE 254-255.

**dimensions of frames:**  
Deutsch Normal – 370x220 mm

**dimensions of cassettes:**  
360x250 mm

# 20-CASSETTE DEUTSCH NORMAL



## CLASSIC line

## PREMIUM line

<b>ID</b>	<b>W20990B_DNM</b>	<b>W209900B_DNM</b>	<b>W209900B_P_DNM</b>
<b>Name</b>	20-cassette honey extractors Ø1200 mm electric, semi-automatic/automatic		20-cassette honey extractors Ø1200 mm electric drive

### TECHNICAL PARAMETERS

<b>Type of frame</b>	20×Deutsch Normal	20×Deutsch Normal	
<b>Drum diameter</b>	Ø1200 mm	Ø1200 mm	
<b>Drive system</b>	Electric bottom	Electric bottom	
<b>Power supply</b>	230V	230V	
<b>Controller</b>	HES-02*	HE-02H*	HE-03
<b>Motor</b>	Motoreducer 1,5kW	Motoreducer 1,5kW	

### DRUM AND BASKET CONSTRUCTION

<b>Thickness</b>	drum 0,6 mm bottom 0,8 mm	0,8 mm
<b>Honey gate</b>	2×stainless 2"	2×stainless 2"
<b>Top bar</b>	Flat bar 60x10 mm powder coated	Flat bar 60x10 mm stainless
<b>Cover</b>	5 mm acrylic glass	8 mm acrylic glass
<b>Legs</b>	Powder coated 60x40 mm	Stainless 60x40 mm
<b>Hinges</b>	Plastic 8 pcs.	Stainless 8 pcs.
<b>Reinforcing frame</b>	Powder coated	Stainless
<b>Cassette material</b>	Stainless rod Ø2 and Ø6 mm	Stainless rod Ø3 and Ø6 mm
<b>Drum rim</b>	Powder coated	Stainless
<b>Drum height</b>	730 mm	730 mm

### ADDITIONAL INFORMATION

<b>Other</b>	Basket with partitions, shipped on pallet	Basket with partitions, shipped on pallet
--------------	---	---

\* Classic line extractors: controller can be exchanged for advanced automatic controller (HE-03) for an extra charge



WARRANTY DETAILS,  
PAGE 254-255.

**dimensions of frames:**  
Deutsch Normal – 370x220 mm

**dimensions of cassettes:**  
360x250 mm



# OTHER HONEY EXTRACTORS

## CLASSIC line

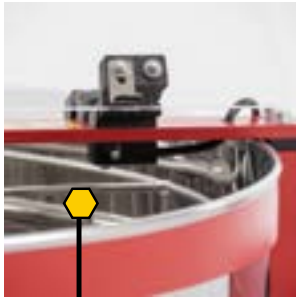

Safety lock - when the lid is opened, the honey extractor is stopped.



Drum height 730 mm made of acid-resistant stainless steel, stainless steel valve mounted at the bottom

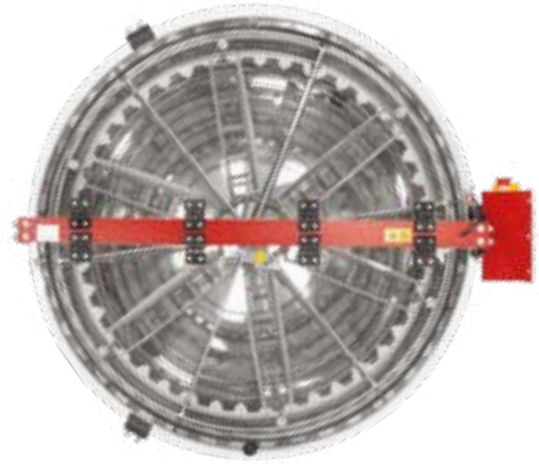

A modern controller, which allows to choose between two manual programs (right-left) and ten automatic programs that can be adjusted.



The drive consists of a worm gear and a three-phase induction motor.

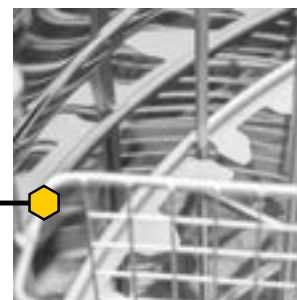

The design of this device can be adapted to current needs - if a large number of frames need to be extracted quickly, a radial arrangement is used. Once the cassettes are mounted in the extractor, the spinning of a smaller number of frames can be done efficiently.

# RADIAL CASSETTE DADANT



## CLASSIC line

## PREMIUM line

ID	W200700K6D	W200700K6D	W200700K6D_P
Name	Radial-cassette honey extractor Dadant, Ø1000 mm, electric drive, semi-automatic/automatic (36 - radial/6 - cassette)		Radial-cassette honey extractor Dadant, Ø1000 mm, electric drive (36 - radial/6 - cassette)

### TECHNICAL PARAMETERS

Type of frame	Dadant	Dadant	
Drum diameter	Ø1000 mm	Ø1000 mm	
Drive system	Electric bottom	Electric bottom	
Power supply	230V	230V	
Controller	HES-02*	HE-02H*	HE-03
Motor	Motoreducer 0,75kW		Motoreducer 0,75kW

### DRUM AND BASKET CONSTRUCTION

Thickness	drum 0,6 mm bottom 0,8 mm	0,8 mm
Honey gate	2×stainless 2"	2×stainless 2"
Top bar	Flat bar 60x10 mm powder coated	Flat bar 60x10 mm stainless
Cover	4 mm acrylic glass	8 mm acrylic glass
Legs	Powder coated 60x40 mm	Stainless 60x40 mm
Hinges	Plastic 8 pcs.	Stainless 8 pcs.
Reinforcing frame	Powder coated	Stainless
Cassette material	Stainless rod Ø2 and Ø5 mm	Stainless rod Ø3 and Ø6 mm
Drum rim	Powder coated	Stainless
Drum height	735 mm	780 mm

### ADDITIONAL INFORMATION

Other	Shipped on pallet	Basket with partitions, shipped on pallet
-------	-------------------	---

\* Classic line extractors: controller can be exchanged for advanced automatic controller (HE-03) for an extra charge  
In the radial system, you can also spin other frames that are dedicated to the radial basket Ø 1000

#### dimensions of frames:

Dadant — 435x300 mm  
Dadant 1/2 — 435x159 mm

#### dimensions of cassettes:

425x340 mm

#### number of frames (top bar: 28 mm standard, 37 mm hoffmann):

Dadant / Dadant 1/2 — 36/36



WARRANTY DETAILS,  
PAGE 254-255.

# RADIAL CASSETTE LANGSTROTH



## CLASSIC line

## PREMIUM line

ID	W2500GK6LN	W25000GK6LN	W25000GK6LN_P
Name	Radial-cassette honey extractor Langstroth, Ø800 mm, electric drive, semi-automatic/automatic (24 - radial/6 - cassette)		Radial-cassette honey extractor Langstroth, Ø800 mm, electric drive (24 - radial/6 - cassette)

### TECHNICAL PARAMETERS

Type of frame	Langstroth	Langstroth	
Drum diameter	Ø800 mm	Ø800 mm	
Drive system	Electric top	Electric bottom	
Power supply	230V	230V	
Controller	HES-02*	HE-02H*	HE-03
Motor	Motoreducer 0,37kW		Motoreducer 0,55kW

### DRUM AND BASKET CONSTRUCTION

Drum thickness	0,6 mm	0,8 mm
Honey gate	Stainless 6/4"	Stainless 6/4"
Top bar	Flat bar 100x10 mm powder coated	Flat bar 60x10 mm stainless
Cover	4 mm acrylic glass	8 mm acrylic glass
Legs	Powder coated 50x30 mm	Stainless 50x30 mm
Hinges	Plastic 4 pcs.	Stainless 8 pcs.
Reinforcing frame	Powder coated	Stainless
Cassette material	Stainless rod Ø2 and Ø5 mm	Stainless rod Ø3 and Ø6 mm
Drum rim	Powder coated	Stainless
Drum height	740 mm	780 mm

### ADDITIONAL INFORMATION

Other	Shipped on pallet	Basket with partitions, shipped on pallet
-------	-------------------	---

\* Classic line extractors: controller can be exchanged for advanced automatic controller (HE-03) for an extra charge  
In the radial system, you can also spin other frames that are dedicated to the radial basket Ø 800

**dimensions of frames:**      **dimensions of cassettes:**  
Langstroth — 450x232 mm      440x250 mm

**number of frames (top bar: 28 mm standard, 37 mm hoffmann):**  
Langstroth — 24



WARRANTY DETAILS,  
PAGE 254-255.

# RADIAL CASSETTE DEUTSCH NORMAL



**CLASSIC**  
line

**PREMIUM**  
line

ID	W2500GK6DNM	W2500GK6DNM	W2500GK6DNM_P
Name	Radial-cassette honey extractor Deutsch Normal, Ø800 mm, electric drive, semi-automatic/automatic (24 - radial/6 - cassette)		Radial-cassette honey extractor Deutsch Normal, Ø800 mm, electric drive (24 - radial/6 - cassette)

## TECHNICAL PARAMETERS

Type of frame	Deutsch Normal	Deutsch Normal	
Drum diameter	Ø800 mm	Ø800 mm	
Drive system	Electric top	Electric bottom	
Power supply	230V	230V	
Controller	HES-02*	HE-02H*	HE-03
Motor	Motoreducer 0,37kW	Motoreducer 0,55kW	

## DRUM AND BASKET CONSTRUCTION

Drum thickness	0,6 mm	0,8 mm
Honey gate	Stainless 6/4"	Stainless 6/4"
Top bar	Flat bar 100x10 mm powder coated	Flat bar 60x10 mm stainless
Cover	4 mm acrylic glass	8 mm acrylic glass
Legs	Powder coated 50x30 mm	Stainless 50x30 mm
Hinges	Plastic 4 pcs.	Stainless 8 pcs.
Reinforcing frame	Powder coated	Stainless
Cassette material	Stainless rod Ø2 and Ø5 mm	Stainless rod Ø3 and Ø6 mm
Drum rim	Powder coated	Stainless
Drum height	645 mm	730 mm

## ADDITIONAL INFORMATION

Other	Shipped on pallet	Basket with partitions, shipped on pallet
-------	-------------------	---

\* Classic line extractors: controller can be exchanged for advanced automatic controller (HE-03) for an extra charge  
In the radial system, you can also spin other frames that are dedicated to the radial basket Ø 800

### dimensions of frames:

Deutsch Normal — 370x220 mm

### dimensions of cassettes:

360x250 mm

### number of frames (top bar: 28 mm standard, 37 mm hoffmann):

Deutsch Normal — 24



WARRANTY DETAILS,  
PAGE 254-255.

# HONEY EXTRACTOR 4-FRAME, TANGENTIAL WITH ELECTRIC DRUM LOWERING Ø600

**MINIMA**  
line

## TECHNICAL PARAMETERS

Type of frame	Universal
Power supply	230V
Controller	MDD-01
Drum tilting drive	Electric actuator
Honey gate	6/4"
Drum inclination	45°
Dimensions	730×900×1100 mm (L×W×H)
Weight	45 kg
Other	Adjustable basket rotation speed up to 300 r.p.m. / min Basket locked with a pin, helpful for people with disabilities



WARRANTY DETAILS,  
PAGE 254-255.

ID	NAME
HEM600D230V_ELC	Honey extractor 4-frames, tangential, universal basket ø600, electric 230V - MINIMA LINE

# HONEY EXTRACTOR 4-CASSETTE WITH ELECTRIC DRUM LOWERING LANGSTROTH Ø720

**CLASSIC**  
line

## TECHNICAL PARAMETERS

Dimensions of cassettes	440×250 mm
Type of frame	4× Langstroth
Power supply	230V
Controller	HE-02H
Drum tilting drive	Electric actuator
Honey gate	6/4"
Drum inclination	45°
Dimensions	900×1100×1200 mm (L×W×H)
Weight	69 kg
Other	Adjustable basket rotation speed up to 300 r.p.m. / min Basket locked with a pin helpful for people with disabilities





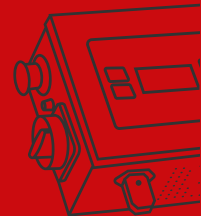

WARRANTY DETAILS,  
PAGE 254-255.

ID	NAME
HEC720C4LN230V_ELC	Electric langstroth ø720 4-cassette honey extractor - CLASSIC LINE

# CONTROLLERS AND ADDITIONAL OPTIONS FOR EXTRACTORS



Controller name	Honey extractor controller BASIC - MDD 230V	Honey extractor controller MINIMA - MDD 230V	Honey extractor controller BASIC - HE-01V 230V	Honey extractor controller MINIMA - SDD-2DP	Honey extractor controller MINIMA - HE-01V
Photo					
Controller board type	MDD-01	MDD-01	HE-01V	SDD-2DP	HE-01V
Index	41240043	41240047	41240186	41240152	41240151
Controller class	BASIC	MINIMA	BASIC	MINIMA	MINIMA
Controller type	Manual potentiometer	Manual potentiometer	Digital	Digital	Digital
Housing	Plastic	Plastic	Plastic	Plastic	Plastic
Honey extractor diameter [mm]	400 - 650	400 - 650	720 - 900	720 - 900	720 - 1000
Honey extractor type	TANGENTIAL / RADIAL / CASSETTE	TANGENTIAL / RADIAL / CASSETTE	RADIAL / CASSETTE	RADIAL	CASSETTE
Number of manual programs	1	1	2	2	2
Number of automatic programs	0	0	10	0	10
Possibility of programming user program	No	No	Yes	No	Yes
Number of user programs	NA	NA	1	NA	1
Inverter	No	No	No	No	No
Full error diagnostics	No	No	No	No	No
Controller mounting location	Beam	Beam	Beam	Beam	Beam
Working time counter	No	No	No	No	No
Safety button	No	No	Yes	No	No
Open cover indication	No	No	"C-STOP" message	No	No
Programming dedicated to the device model	No	No	Yes	Yes	Yes
Changing the direction of rotation of the cassettes	Manual mode	Manual mode	Automatic mode	NA	Automatic mode
Input power [V]	230	230	230	12	12
Motor	18V / 80W	18V / 80W	12V / 150W	24V / 250W 24V / 350W	24V / 250W 24V / 350W
Language selection	No	No	NA	NA	NA
Warranty [months]	24	24	24	24	24
Additional	-	-	-	-	-



## MDD CONTROLLER WITH BATTERY POWER SUPPLY

ID	NAME
41240111	MDD controller with battery power supply

**DEVICE SPECIFICATIONS:**

- alternative solution to standard control
- 18V power supply
- smooth speed regulation
- battery discharge indicator light (red)
- LED indicating activation of the controller (green)

Working time of the controller with battery power supply:

- up to 3h of operation on a single 18V 2.5Ah battery\*.
- up to 5h of operation on a single 18V 4Ah battery\*.

**DIMENSIONS:**

- height - 260 mm
- width - 140 mm
- depth - 120 mm
- weight - 0.48 kg

**Charger and battery not included in the offer.**

Controller name	Honey extractor controller 12VDC / 230VAC SDD-2DP	Honey extractor controller 12VDC / 230VAC SDD-2DP	Honey extractor controller 12VDC / 230VAC SDD-3 Premium	Honey extractor controller HE-01 Full 12/230V
Photo				
Controller board type	SDD-2DP	SDD-2DP	SDD-3	HE-01V
Index	41240064	41240079	41240051	41240011
Controller class	OPTIMA	CLASSIC	PREMIUM	OPTIMA
Controller type	Digital	Digital	Digital	Digital
Housing	Black sheet metal, powder coated	Black sheet metal, powder coated	Stainless steel	Black sheet metal, powder coated
Honey extractor diameter [mm]	500 - 650	500 - 650	500 - 650	720 - 1000
Honey extractor type	TANGENTIAL / RADIAL / CASSETTE	TANGENTIAL / RADIAL	TANGENTIAL / RADIAL	CASSETTE
Number of manual programs	10	10	10	2
Number of automatic programs	0	0	0	9
Possibility of programming user program	No	No	No	Yes
Number of user programs	NA	NA	NA	1
Inverter	No	NA	No	No
Full error diagnostics	No	NA	Yes	No
Controller mounting location	Beam	Leg	Leg	Leg
Working time counter	No	No	Leg	No
Safety button	Yes	Yes	Yes	Yes
Open cover indication	Effect on the display"hr"	Effect on the display"hr"	"EMG STOP" message	"C-STOP" message
Programming dedicated to the device model	No	No	No	Yes
Changing the direction of rotation of the cassettes	Manual mode	NA	NA	Automatic mode
Input power [V]	12 / 230	12 / 230	12 / 230	12 / 230
Motor	24 V / 250W	24 V / 250W	24V / 350W	24V / 250W 24V / 350W
Language selection	NA	NA	NA	NA
Warranty [months]	24	24	36	24
Additional	-	-	The WIFI option allows you to control using e.g. a phone. Reporting required when purchasing such an option	-



## CONTROLLER MDD FOR EXTRACTOR MINIMA POWER

The proposed control is an extended version of the control used in MINIMA and BASIC honey extractors. The MINIMA POWER MDD controller is more efficient, achieving many more revolutions than the standard MINIMA controller.

ID	NAME
41240084	Controller MDD for extractor MINIMA POWER

Controller name	Honey extractor controller, semi-automatic HES-02 0.75kW 230V, leg	Honey extractor controller, semi-automatic HES-02 0.75kW 230V, beam	Honey extractor controller, semiautomatic HES-02 1,5kW 230V, leg	Honey extractor controller, automatic HE-02H 0,75kW 230V, leg	Honey extractor controller, automatic HE-02H 0,75kW 230V, beam
Photo					
Controller board type	HES-02	HES-02	HES-02	HE-02H	HE-02H
Index	41240033	41240032	41240035	41240021	41240020
Controller class	CLASSIC	CLASSIC	CLASSIC	CLASSIC	CLASSIC
Controller type	Manual potentiometer	Manual potentiometer	Manual potentiometer	Digital	Digital
Housing	Black sheet metal, powder coated	Black sheet metal, powder coated	Black sheet metal, powder coated	Black sheet metal, powder coated	Black sheet metal, powder coated
Honey extractor diameter [mm]	720 - 1200	720 - 1200	1200	720 - 1200	720 - 1200
Honey extractor type	RADIAL / CASSETTE	RADIAL / CASSETTE	CASSETTE	RADIAL / CASSETTE	RADIAL / CASSETTE
Number of manual programs	2	2	2	2	2
Number of automatic programs	1	1	1	A1 - A10 - simple - automatic calculation of the spin time by the controller B1 - B10 - advanced - defining the next steps	A1 - A10 - simple - automatic calculation of the spin time by the controller B1 - B10 - advanced - defining the next steps
Possibility of programming user program	No	No	No	Yes	Yes
Number of user programs	NA	NA	NA	23	23
Inverter	MITSUBISHI ELECTRIC	MITSUBISHI ELECTRIC	MITSUBISHI ELECTRIC	MITSUBISHI ELECTRIC	MITSUBISHI ELECTRIC
Full error diagnostics	No	No	No	Yes	Yes
Controller mounting location	Leg	Beam	Leg	Leg	Beam
Working time counter	Yes	Yes	Yes	Yes	Yes
Safety button	Yes	Yes	Yes	Yes	Yes
Open cover indication	Middle LED flashing	Middle LED flashing	Middle LED flashing	"STOP COVER OPEN!" message	"STOP COVER OPEN!" message
Programming dedicated to the device model	Yes	Yes	Yes	Yes	Yes
Changing the direction of rotation of the cassettes	Automatic mode	Automatic mode	Automatic mode	Automatic mode	Automatic mode
Input power [V]	230	230	230	230	230
Motor	0,37kW / 400V 0,55kW / 400V 0,75kW / 400V	0,37kW / 400V 0,55kW / 400V 0,75kW / 400V	1,1kW / 400V 1,5kW / 400V	0,37kW / 400V 0,55kW / 400V 0,75kW / 400V	0,37kW / 400V 0,55kW / 400V 0,75kW / 400V
Language selection	0,37kW / 400V 0,55kW / 400V 0,75kW / 400V	NA	NA	17	17
Warranty [months]	24	24	24	24	24
Additional	-	-	-	The controller has the ability to program 3 special programs for thick honey extraction  Note: Cassette mode up to 12 cassettes Available languages: PL, EN, LU, LT, IT, HU, FR, FI, ES, DE, CS, BG, UA, TR, SV, RU, RO	The controller has the ability to program 3 special programs for thick honey extraction  Available languages: PL, EN, LU, LT, IT, HU, FR, FI, ES, DE, CS, BG, UA, TR, SV, RU, RO



## POWER ADAPTOR WITH WIRE EMBEDDING FUNCTION

- Dedicated for 12V electric honey extractors
- 230V input voltage with an option of 110V

- Output voltage 12V
- Power 250W
- Max current 21A

ID	NAME
W3305	Power adaptor 230V to 12V for extractors with power supply 12V with diameter Ø720 mm to Ø1000 mm, with wire embedding function, 400W

Controller name	Honey extractor controller, automatic HE-02H 1,5kW 230V	Honey extractor controller HE-03 0,75kW 230V Premium	Honey extractor controller HE-03 1,5kW 230V Premium
Photo			
Controller board type	HE-02H	HE-03	HE-03
Index	41240023	41240102	41240040
Controller class	CLASSIC	PREMIUM	PREMIUM
Controller type	Digital	LCD	LCD
Housing	Black sheet metal, powder coated	Stainless steel	Stainless steel
Honey extractor diameter [mm]	1200	720 - 1200	1200
Honey extractor type	CASSETTE	RADIAL / CASSETTE	RADIAL / CASSETTE
Number of manual programs	2	2	2
Number of automatic programs	A1 - A10 - simple - automatic calculation of the spin time by the controller B1 - B10 - advanced - defining the next steps	8	8
Possibility of programming user program	Yes	Yes	Yes
Number of user programs	23	8	8
Inverter	mitsubishi electric	mitsubishi electric	mitsubishi electric
Full error diagnostics	Yes	Yes	Yes
Controller mounting location	Leg	Leg	Leg
Working time counter	Yes	Yes	Yes
Safety button	Yes	Yes	Yes
Open cover indication	"STOP COVER OPEN!" message	Text message + animation on the display	Text message + animation on the display
Programming dedicated to the device model	Yes	Yes	Yes
Changing the direction of rotation of the cassettes	Automatic mode	Automatic mode	Automatic mode
Input power [V]	230	230	230
Motor	1,1kW / 400V 1,5kW / 400V	0,55kW / 400V 0,75kW / 400V	1,1kW / 400V 1,5kW / 400V
Language selection	17	32	32
Warranty [months]	24	36	36
Additional	The controller has the ability to program 3 special programs for thick honey extraction Note: Cassette mode above 12 cassettes Available languages: PL, EN, LU, LT, IT, HU, FR, FI, ES, DE, CS, BG, UA, TR, SV, RU, RO"	Available languages: EN, PL, RU, DE, FR, CS, SK, RO, BG, AR, ES, SV, FI, NO, TR, IT, HU, EL, NL, DA, UK, BE, LT, LV, ET, PT, SR, HE, BS, SL ,ZH, JA	Possibility of powder coating the controller in red - change of material - black sheet metal

## SPUNBOND COVER FOR HONEY EXTRACTOR



## CORDURA COVER FOR HONEY EXTRACTOR



ID	NAME
6064_500_G	Spunbond cover for honey extractor, top controller, Ø500 mm
6064_500_B	Spunbond cover for honey extractor, side controller, Ø500 mm
6064_600_G	Spunbond cover for honey extractor, top controller, Ø600 mm
6064_600_B	Spunbond cover for honey extractor, side controller, Ø600 mm
6064_650_G	Spunbond cover for honey extractor, top controller, Ø650 mm
6064_650_B	Spunbond cover for honey extractor, side controller, Ø650 mm
6064_720_G	Spunbond cover for honey extractor, top controller, Ø720 mm
6064_720_B	Spunbond cover for honey extractor, side controller, Ø720 mm
6064_800_G	Spunbond cover for honey extractor, top controller, Ø800 mm
6064_800_B	Spunbond cover for honey extractor, side controller, Ø800 mm
6064_900_G	Spunbond cover for honey extractor, top controller, Ø900 mm
6064_900_B	Spunbond cover for honey extractor, side controller, Ø900 mm
6064_1000_B	Spunbond cover for honey extractor, side controller, Ø1000 mm
6064_1200_B	Spunbond cover for honey extractor, side controller, Ø1200 mm

ID	NAME
6065_500_G	Cordura cover for honey extractor, top controller, Ø500 mm
6065_500_B	Cordura cover for honey extractor, side controller, Ø500 mm
6065_600_G	Cordura cover for honey extractor, top controller, Ø600 mm
6065_600_B	Cordura cover for honey extractor, side controller, Ø600 mm
6065_650_G	Cordura cover for honey extractor, top controller, Ø650 mm
6065_650_B	Cordura cover for honey extractor, side controller, Ø650 mm
6065_720_G	Cordura cover for honey extractor, top controller, Ø720 mm
6065_720_B	Cordura cover for honey extractor, side controller, Ø720 mm
6065_800_G	Cordura cover for honey extractor, top controller, Ø800 mm
6065_800_B	Cordura cover for honey extractor, side controller, Ø800 mm
6065_900_G	Cordura cover for honey extractor, top controller, Ø900 mm
6065_900_B	Cordura cover for honey extractor, side controller, Ø900 mm
6065_1000_B	Cordura cover for honey extractor, side controller, Ø1000 mm
6065_1200_B	Cordura cover for honey extractor, side controller, Ø1200 mm

# HEATING OPTIONS

- Perfect for extracting dense honey or for use in colder environments
- Extractors equipped with semi-automatic or automatic controller (per request) allowing for programming accurate extraction cycle
- Digital temperature controller to ensure that honey does not overheat
- Temperature range from 30 to 55°C
- Optional second honey gate available



<b>PD720</b>	Heated bottom, Ø720 mm extractor
<b>PD800</b>	Heated bottom, Ø800 mm extractor
<b>PD900</b>	Heated bottom, Ø900 mm extractor
<b>PD1000</b>	Heated bottom, Ø1000 mm extractor
<b>PD1200</b>	Heated bottom, Ø1200 mm extractor

<b>PB720</b>	Heated drum side wall, Ø720 mm extractor
<b>PB800</b>	Heated drum side wall, Ø800 mm extractor
<b>PB900</b>	Heated drum side wall, Ø900 mm extractor
<b>PB1000</b>	Heated drum side wall, Ø1000 mm extractor
<b>PB1200</b>	Heated drum side wall, Ø1200 mm extractor

# HANDLES FOR HONEY EXTRACTORS

Universal handles for carrying the honey extractor are placed under the honey extractor drum, at the connection point between honey extractor's legs and the trestle.



- Made of stainless steel.
- Weight of 1 piece - 0.335 kg
- Suggested purchase quantity 3 pcs.

ID	NAME
<b>W6600</b>	Honey extractor's handle with a diameter 720-1500 mm - 1 pc

# SET OF CASTERS FOR HONEY EXTRACTORS

A set of casters has been created specifically for honey extractors with 60-70 mm wide feet, providing a convenient and efficient way of transporting them. The set includes three pads that are easy to assemble and disassemble.

Thanks to their sturdy construction, they provide stability when transporting honey extractors.



ID	NAME
<b>W200001</b>	Set of casters for honey extractors (leg width up to 60-70 mm), 3 pcs

# ANTI-VIBRATION PADS FOR HONEY EXTRACTORS

If you want to protect your honey extractors from falling into vibrations while extracting the honey, anti-vibration pads will be a great solution. Very often, extracted frames have different weights due to the different contained honey. Research has shown that in the case of honey extractors with the anti-vibration pads, they vibrate at 25% higher revolutions. The pads are made of PVC (SOFT) material.



ID	NAME
<b>P_AM1</b>	Anti-vibration pad for Basic, Minima and Optima honey extractors with a diameter from Ø 400 to Ø 650 mm - set of 3 (weight of 3 pieces: 52.8 g)
<b>P_AM2</b>	Anti-vibration pad for Classic honey extractors with a diameter from Ø 500 to Ø 650 mm - set of 3 (weight of 3 pieces: 75 g)
<b>P_AM4</b>	Anti-vibration pad for honey extractors with a diameter from Ø 720 to Ø 900 mm and for Minima and Optima honey extractors with a diameter of Ø 1000 mm (leg in honey extractors 50 x 30 mm) - set of 3 (weight of 3 pieces: 92.7 g)
<b>P_AM5</b>	Anti-vibration pad for honey extractors with a diameter from Ø 1000 to Ø 1500 mm (leg in honey extractors in the size of 60 x 40 mm), except for honey extractors with a diameter of Ø 1000 from the Minima and Optima lines - set of 3 (weight of 3 pieces: 136.8 g)

## 2. HONEY PROCESSING



# AUTOMATIC HONEY EXTRACTION LINES

Lines for uncapping and honey extraction for 40 and 100 frames are dedicated to owners of apiaries and honey producers who value time, efficiency, and high-quality products. They are ideal for professionals seeking a reliable and effective solution for honey harvesting.

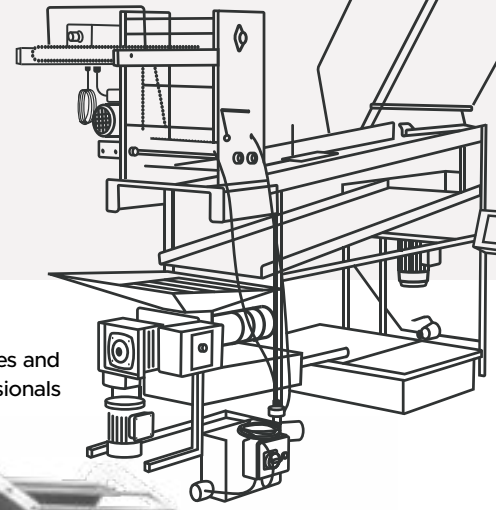

**PREMIUM**  
line

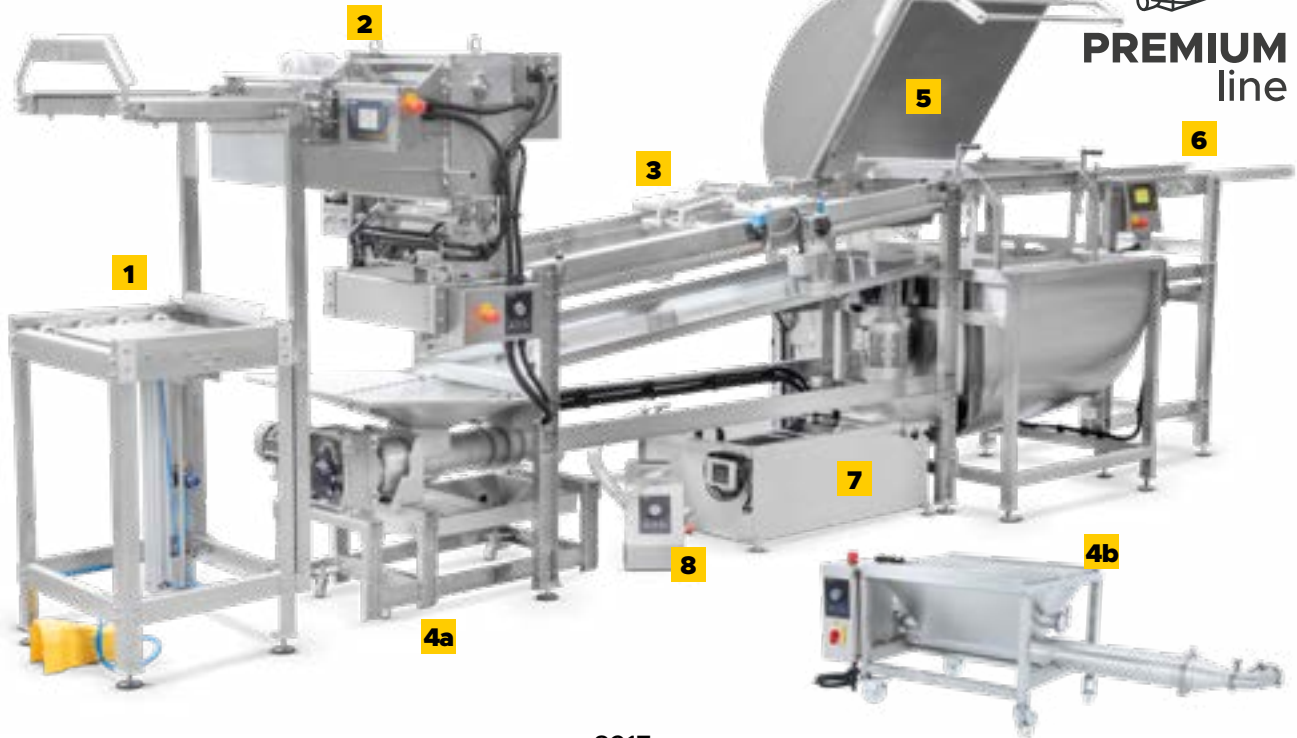

8217 mm

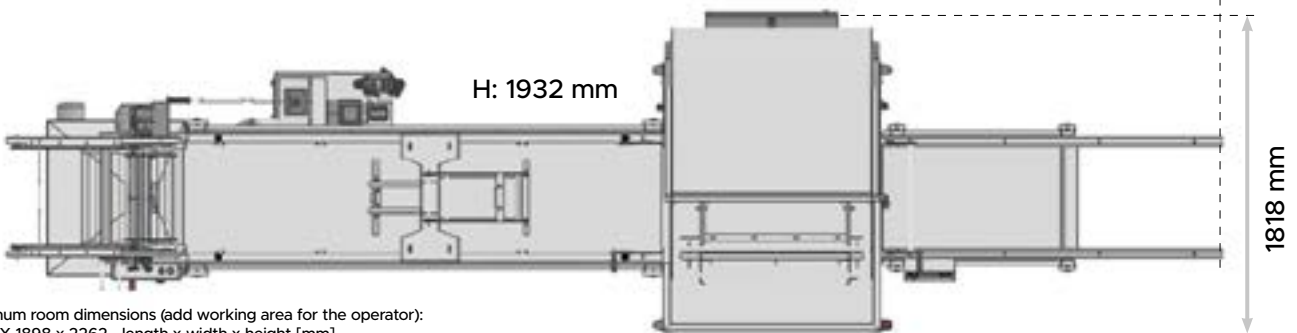

Minimum room dimensions (add working area for the operator):  
8217 X 1898 x 2262 - length x width x height [mm]

## W20950\_P1

The line consists of:

1. Pneumatic frame ejector
2. Module for uncapping frames
3. Electric frame transporting carrier
4. Capping extruder
5. Horizontal honey extractor for 100 frames
6. Frame receiver
7. Honey sump
8. Honey pump

## W20950\_P2

The line consists of:

1. Pneumatic frame ejector
2. Module for uncapping frames
3. Electric frame transporting carrier
4. Screw conveyor
5. Horizontal honey extractor for 100 frames
6. Frame receiver
7. Honey sump
8. Honey pump

\*Requires additional equipment. Our offer includes a capping spinner - W4801

ID	NAME
W20950_P1	Honey extraction line, 100 frames, version with: cappings extruder (100 kg)
W20950_P2	Honey extraction line, 100 frames, version with: screw conveyor (100 kg)

**PREMIUM**  
line

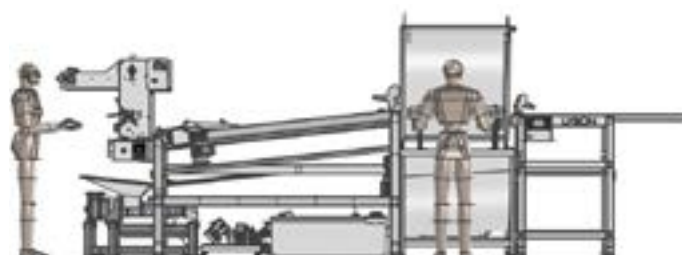
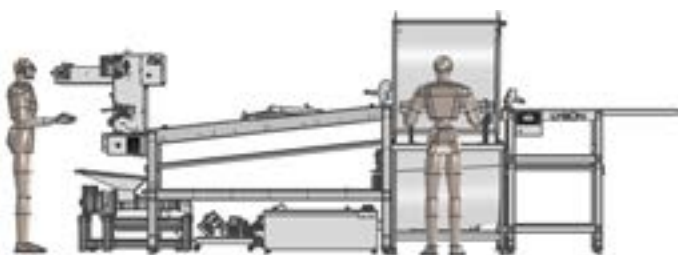
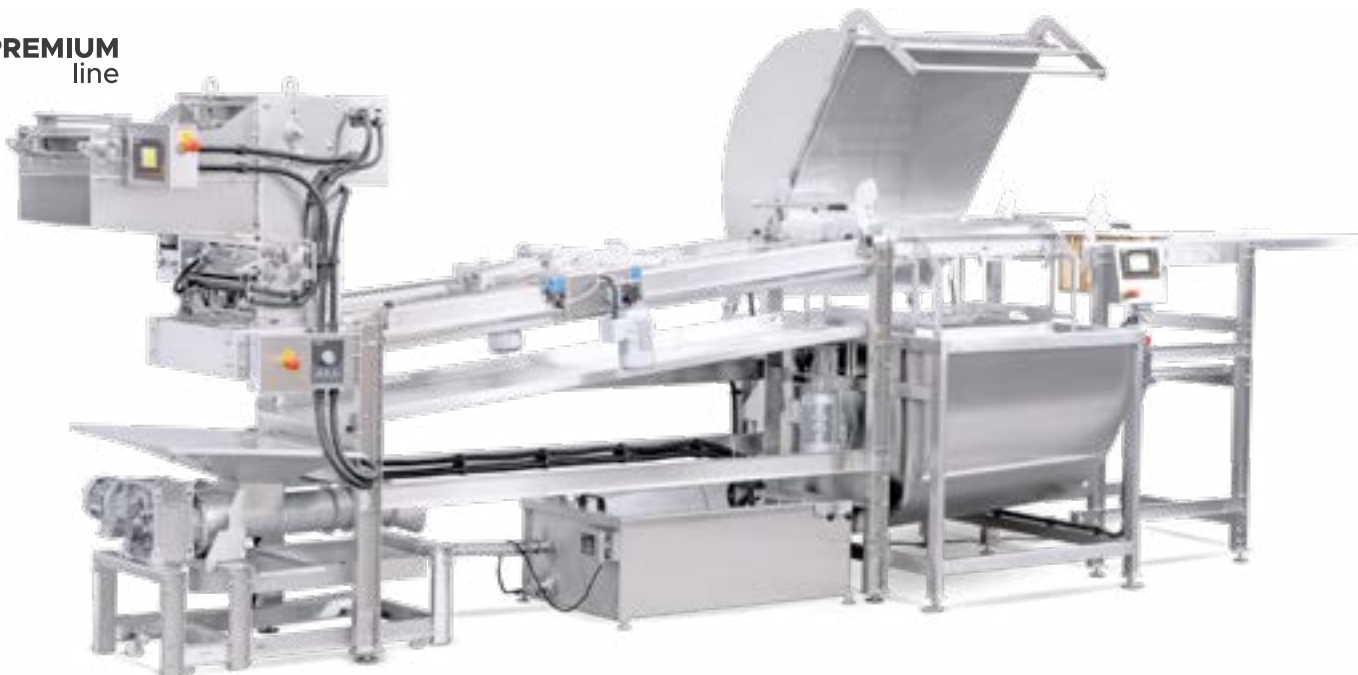

**Honey extraction line, 40-frame, consisting of:** a two-section horizontal honey extractor, a PREMIUM frame uncapping module with a chain feeder, a 100 kg uncapping extruder, a 0.37 kW honey pump, 230V, a honey sump with an electronic honey level sensor, a single-section frame receiver, a manual frame transport carrier (2.1 m)

**Honey extraction line, 40-frame, consisting of:** a two-section horizontal honey extractor, a PREMIUM frame uncapping module with a chain feeder, a 100 kg uncapping extruder, a 0.37 kW honey pump, 230V, a honey sump with an electronic honey level sensor, a single-section frame receiver, an electric frame transport carrier (2.1 m)

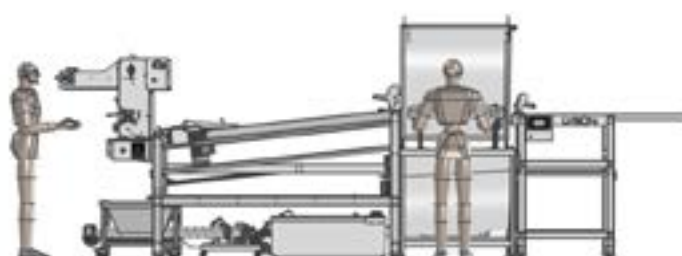
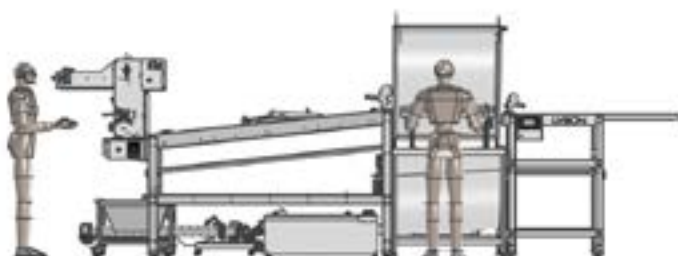

**Honey extraction line, 40-frame, consisting of:** a two-section horizontal honey extractor, a PREMIUM frame uncapping module with a chain feeder, a screw conveyor, a 0.37 kW honey pump, 230V, a honey sump with an electronic honey level sensor, a single-section frame receiver, a manual frame transport carrier (2.1 m)

**Honey extraction line, 40-frame, consisting of:** a two-section horizontal honey extractor, a PREMIUM frame uncapping module with a chain feeder, a screw conveyor, a 0.37 kW honey pump, 230V, a honey sump with an electronic honey level sensor, a single-section frame receiver, an electric frame transport carrier (2.1 m)

ID	NAME
W20951_P1	Honey extraction line, 40 frames, version with uncapping machine PREMIUM, cappings extruder (100 kg), manual frame transporting carrier (2,1 m)
W20951_P2	Honey extraction line, 40 frames, version with uncapping machine PREMIUM, screw conveyor, manual frame transporting carrier (2,1 m)
W20951_P3	Honey extraction line, 40 frames, version with uncapping machine PREMIUM, cappings extruder (100 kg), electric frame transporting carrier (2,1 m)
W20951_P4	Honey extraction line, 40 frames, version with uncapping machine PREMIUM, screw conveyor, electric frame transporting carrier (2,1 m)

# TAKE A CLOSER LOOK AT THE DETAILS OF OUR MODIFIED HONEY EXTRACTION LINES!

W20950\_P1



## PNEUMATIC FRAME EJECTOR

A revolutionary system that automatically and effortlessly removes frames from the hive body and places them on the uncapping feeder.

Technical Specifications:

- Stainless steel frame
- Stainless steel rollers for transporting hive bodies above the ejector table
- Pneumatic footswitch
- Pressure reducer
- Pneumatic actuator



W2096G\_L40



ID	NAME
W2096G	OPTION G - Pneumatic frame ejector for uncapping tables with uncapping machine
W2096G_L40	Pneumatic frame ejector (40-frame extraction line)

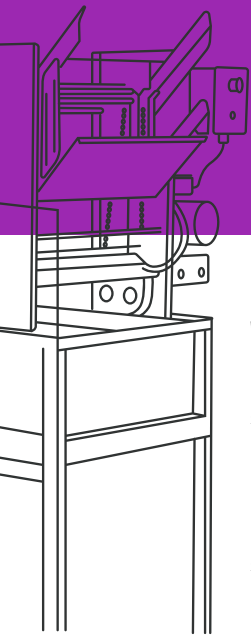

## UNCAPPING MACHINES WITH BLADES HEATED WITH STEAM OR CLOSED CIRCUIT

Uncapping machine – supporting structure:

- 1500 mm acid-resistant stainless steel table or frame holder

Uncapping machine – drive system:

- Power supply: 230 V
- Motor: 0.37 kW
- Motor speed: 1,400 rpm

Heated blades: steam generator consists of:

- tank with heater
- hoses feeding steam to the blades
- the condensate container
- dimensions: 290×260×230 mm
- power supply: 230V
- heating power: 1850 - 2000W

Uncapping machine dimensions:

- 900×800×700 mm

Table construction:

- stainless steel
- legs - powder coated
- valve - stainless steel flap valve
- stainless screens - 2 pcs.

### OPTION 1

Blades heater - closed circuit system:

- Stainless steel tank with integrated heater
- Lines supplying heating liquid to the blades
- Control box
- Dimensions: 420 × 500 × 390 mm
- Power supply: 230 V
- Heating power: 2,000 W
- Weight: 8 kg

### OPTION 2

Blades heater - steam generator system:

- Tank with integrated heater
- Hoses feeding steam to the blades
- Condensate tank
- Dimensions: 290 × 260 × 230 mm
- Power supply: 230 V
- Heating power: 1,850–2,200 W
- Weight: 2.5 kg



**MINIMA**  
line

ID	NAME
W2092_W	Uncapping machine with blades, heated with steam generator, 230V, with chain feeder, with a table 1500 mm - MINIMA
W2092_Z	Uncapping machine with closed circuit, 230V, with chain feeder, with a table 1500 mm - MINIMA
W2092S_W	Uncapping machine with blades, heated with steam generator, 230V, with slides, with a table 1500 mm - MINIMA
W2092S_Z	Uncapping machine with closed circuit, 230V, with slides, with a table 1500 mm - MINIMA
W2093_W	Uncapping machine with blades, heated with steam generator, 230V, with chain feeder, with a frame holder 1500 mm - MINIMA
W2093_Z	Uncapping machine with closed circuit, 230V, with chain feeder, with a frame holder 1500 mm - MINIMA
W2093S_W	Uncapping machine with blades, heated with steam generator, 230V, with slides, with a frame holder 1500 mm - MINIMA
W2093S_Z	Uncapping machine with closed circuit, 230V, with slides, with a frame holder 1500 mm - MINIMA
W20970_1	OPTION 1: Capping extruder, capacity up to 50 kg/h, for the uncapping machines Minima or Classic Line with a frame holder 1500 mm
W20966_2	OPTION 2: Capping extruder, capacity up to 100 kg/h, for the uncapping machines Minima or Classic Line with a frame holder 1500 mm

# UNCAPPING MACHINES

WITH BLADES HEATED WITH STEAM OR CLOSED CIRCUIT

**MINIMA**  
line

Drive:

- power supply - 230V
- engine - 0,37kW
- engine revolutions - 1,400 rpm

Heated blades: closed circuit consists of:

- stainless steel tank with a heater
- hose supplying liquid to the blades
- control box
- dimensions: 420 x 500 x 390 mm
- power supply: 230V
- heating power: 3000W

Uncapping machine dimensions:

- length - 900 mm
- width - 800 mm
- height - 700 mm



ID	NAME
W20921_W	Uncapping machine with blades, heated with steam generator, 230V, with chain feeder - MINIMA *
W20921_Z	Uncapping machine with closed circuit, 230V, with chain feeder - MINIMA *
W20921S_W	Uncapping machine with blades, heated with steam generator, 230V, with slides - MINIMA *
W20921S_Z	Uncapping machine with closed circuit, 230V, with slides - MINIMA *

\*Uncapping machine (module) without a table/frame holder.

# UNCAPPING MACHINE

WITH MANUAL FEEDER AND HOLDING TABLE

**CLASSIC**  
line

Specifications:

- Power supply 230V/50Hz
- Power of blades drive motor 0.18kW
- Steam generator's voltage 230V
- Heating power - 2000W
- Water capacity - 4 l
- Warm-up time - 15 min.
- Expected steam generator's working time - 1 h

W20960	Uncapping machine with manual feeder, with steam generator, 230V, with a table 1500 mm - CLASSIC
W2096C	Option C: Frame slides mounted in uncapping table with manual feeder, with a table - CLASSIC

Steam generator for heating the blades, equipped with minimum and maximum water level indicators.



Note:  
The steam generator may differ from the one shown in the photo.

# UNCAPPING MACHINES

## WITH AUTOMATIC FEEDER AND HOLDING TABLE

**CLASSIC**  
line

We offer automatic feeder uncapping machines in two options:

- with liquid heated blades
- with electric heated blades.



45090012

Specifications of the uncapping machines with liquid heated blades:

- Knife motor power – 0.18kW
- Feeder motor power – 0.12kW
- Feeder's speed – 9 RPM
- Blades heating power – 2kW
- Heating system warm-up time: 20 minutes
- Efficiency – 4 frames/minute

Specifications of the uncapping machines with electric heated blades:

- Knife motor power – 0.18kW
- Feeder motor power – 0.12kW
- Feeder's speed – 9 RPM
- Heating power – 2 × 400W
- Heaters' voltage – 24V
- Blades warm-up time of about 5 minutes
- Efficiency – 4 frames/minute



W209600E

The uncapping machine is equipped with a mechanical feeder that automatically feeds the frames into the uncapper. The liquid heated blades are equipped with a liquid level indicator.

**OPTION A: Cover and heated bottom**  
In this option, the table on which the uncapping machine is mounted features a heated bottom (650 W), a temperature controller, and a cover, which significantly extends the time available for separating residual honey from the wax.

UNCAPPING MACHINE WITH AUTOMATIC FEEDER	
W209600E	400V, with electric heated blades, with a table 1500 mm - CLASSIC
W2096000E	230V, with electric heated blades, with a table 1500 mm - CLASSIC
W209600Z	400V, with closed circuit, with a table 1500 mm - CLASSIC
W2096000Z	230V, with closed circuit, with a table 1500 mm - CLASSIC
W2096A	OPTION A: Cover and heated bottom in uncapping table with automatic feeder, with a table 1500 mm
45090012	Cover for uncapping machine

# UNCAPPING MACHINES

WITH MANUAL OR AUTOMATIC FEEDER AND FRAME HOLDER

**CLASSIC**  
line



UNCAPPING MACHINE WITH FRAME HOLDER 1500 MM	
<b>W901R</b>	with manual feeder, 230V - CLASSIC
<b>W902E</b>	with automatic feeder, 400V, with electric heated blades - CLASSIC
<b>W902Z</b>	with automatic feeder, 400V, with closed circuit - CLASSIC
<b>W903E</b>	with automatic feeder, 230V, with electric heated blades - CLASSIC
<b>W903Z</b>	with automatic feeder, 230V, with closed circuit - CLASSIC

<b>W20984</b>	Manual uncapping table with capping extruder, capacity up to 50kg/h
<b>W20980</b>	Manual uncapping table with capping extruder, capacity up to 100 kg/h



We recommend the following options for use with the presented automatic or manual uncapping machines. When placing an order for an uncapping machine, please let us know if you are interested in any of the options listed below.

<b>W20970_1</b>	<b>OPTION 1:</b> Capping extruder, capacity up to 50 kg/h, for the uncapping machines Minima or Classic Line with a frame holder 1500 mm
<b>W20966_2</b>	<b>OPTION 2:</b> Capping extruder, capacity up to 100 kg/h, for the uncapping machines Minima or Classic Line with a frame holder 1500 mm
<b>W910</b>	<b>OPTION 3:</b> Uncapping plastic tray with sieve (5 pcs per set) for the uncapping machines Minima or Classic Line with a frame holder 1500 mm

# CAPPING EXTRUDERS

## OPTIMA LINE

Stainless tray included.



**Control system:**

The L-O-P switch has no screw-rotation adjustment available. The controller and the gear's casing is made of powder-coated steel.

<b>W20970_OP</b>	Capping extruder, capacity up to 50 kg/h - OPTIMA
<b>W20966_OP</b>	Capping extruder, capacity up to 100 kg/h - OPTIMA

**W20970\_OP**

Specifications:

- Cappings extruder up to 50 kg/h
- motor 0,55kW, 400V
- motoreducer casing material – powder coated steel
- 14 RPM
- Dimensions: height 68 cm, width 40 cm, length 105 cm



**W20966\_OP**

Specifications:

- Cappings extruder up to 100 kg/h
- motor 0,55kW, 400V
- motoreducer casing material – powder coated steel
- 9 RPM
- Dimensions: height 80 cm, width 53 cm, length 120 cm

# UNCAPPING MACHINES WITH AUTOMATIC FEEDER AND FRAME HOLDER

**PREMIUM**  
line

Uncapping machines from the PREMIUM LINE are entirely made of stainless steel. The device is equipped with an intuitive controller that manages its operation. For the presented uncapping tables, we recommend one of the following options. Please let us know if you choose any of them.

The ejector simplifies lifting honey frames from the honey super by using a pneumatic jack, effortlessly activated via a foot-operated valve. Designed to perfectly fit your honey supers, the ejector integrates seamlessly into your existing setup.



W2096G



W910Z\_P

UNCAPPING MACHINE WITH AUTOMATIC FEEDER AND FRAME HOLDER 1500 MM	
W902Z_P	400V, with closed circuit - PREMIUM
W903Z_P	230V, with closed circuit - PREMIUM
W911Z_P	400V, with closed circuit, with chain feeder - PREMIUM
W910Z_P	230V, with closed circuit, with chain feeder - PREMIUM
W20966_A	<b>OPTION A:</b> Capping extruder, capacity up to 100 kg/h, for the uncapping machines Premium Line with a frame holder 1500 mm
W20965_B	<b>OPTION B:</b> Capping extruder, capacity up to 200 kg/h, for the uncapping machines Premium Line with a frame holder 1500 mm
W2096P	Chain feeder for uncapping machines PREMIUM (W902Z_P, W903Z_P)
W2096G	Pneumatic frame ejector for uncapping machines PREMIUM (W902Z_P, W903Z_P)

# CAPPING EXTRUDERS CLASSIC LINE

## W20966

Specifications:

- Efficiency: up to 100 kg/h
- Power supply 230V
- Power 0,55kW
- Adjustable speed: max 9 RPM
- Dimensions: height 80 cm, width 52 cm, length 128 cm

## W20965

Specifications:

- Efficiency: up to 200 kg/h
- Power supply 230V
- Power 2,2kW
- Adjustable speed: max 5 RPM
- Dimensions: height 92 cm, width 75 cm, length 135 cm

The machine is compact sized and user-friendly. Controller allows to adjust the speed. The device is equipped with wheels for easy moving.

## W20970

Specifications:

- Efficiency: up to 50 kg/h
- Power supply 230V
- Power 0,55kW
- Adjustable speed: max 14 RPM
- Dimensions: height 68 cm, width 41 cm, length 105 cm



W20970	Cappings extruder, capacity up to 50 kg/h
W20966	Cappings extruder, capacity up to 100 kg/h
W20965	Cappings extruder, capacity up to 200 kg/h

# ROTARY STAND FOR BEE FRAMES, UNIVERSAL



Specifications:

- sliding upper comb allows the carousel to be adjusted to fit any frame; secured with two adjusting handles
- capacity: supports up to 30 frames simultaneously
- carousel basket with laser-cut frame cutouts
- centrally located valve in the hopper for easy honey drainage
- integrated shelf designed to hold a container for dripping honey
- wheels with brakes for easy movement around the workspace and stable stopping of the carousel



<b>W20670</b>	Rotary stand for bee frames, universal, Ø900 mm
---------------	---

# SCREW CONVEYOR 230V

Technical data:

- made of stainless steel, grade 1.4301
- inlet chute dimensions:
  - length 670mm
  - width 610mm
- screw diameter 95mm
- outlet, TC50 connector
- stepless adjustment of screw speed up to max. 140 rpm
- float switch for controlling the level of the wax and honey in the chute
- motor power 0,75kW
- power supply 230V

Dimensions:

- length 1510mm
- width 615mm
- height 520mm

Weight:

- net weight – 80 kg



<b>W20971_230V</b>	Screw conveyor 230V
<b>W20971_230V_OPTION</b>	OPTION Screw conveyor 230V for uncapping machines Minima, Classic or Premium Line with a frame holder 1500 mm

# MANUAL PRESSES

Parameters of the press:

- press made of acid-resistant stainless steel
- rack made of powder-coated steel
- tank bore diameter: 250 mm
- tank height: 355 mm
- height of the press (without crank): 725 mm
- length of the drain tray: 390 mm
- width of the drain tray: 345 mm

<b>W4082NR</b>	Manual wax press, with crank drive
<b>W4082</b>	Manual wax press, with screw drive
<b>P_AM4PR</b>	Anti-vibration pad for manual wax press - set of 4 pcs.



W4082NR

W4082

# PROFESSIONAL CAPPING SPINNER

The wax separator (spinner) is an essential tool for efficiently removing honey residues from wax cappings. This is especially important for large apiaries, where honey production volume is high. The device simplifies the separation process and, more importantly, significantly improves its efficiency.

Specifications:

- acid-resistant stainless steel
- perforated sheet inserts Ø1 -4 pcs.
- electromagnetic cover lock
- power supply 230V/16A
- power output 2,2kW
- basket rotation speed: MAX 900 RPM

Dimensions:

- height - 1300 mm
- weight - 265 kg
- drum diameter - Ø850 mm



<b>W4801</b>	Professional capping spinner
--------------	------------------------------

# CAPPING SPINNER

Specifications:

- Acid-resistant stainless steel
- Power supply 230V
- Motor power 550W
- Drain valve 2"



<b>W4800</b>	Capping spinner
--------------	-----------------

# MANUAL STEAM UNCAPPERS

Note:  
The steam generator may differ from the one shown in the photo.



The set allows installation on uncapping table (plain or reinforced) with a length of 1000 mm. Steam heated blades accelerate frame uncapping process (steam generator included).

Specifications:

- Made of acid-resistant stainless steel
- Available for following frame standards Deutsch Normal, Dadant, Langstroth

MANUAL STEAM UNCAPPER	
<b>W20960C</b>	Dadant with steam generator, 1000 mm
<b>W20960F</b>	Deutsch Normal with steam generator, 1000 mm
<b>W20960LN</b>	Langstroth with steam generator, 1000 mm

# VERTICAL MANUAL UNCAPPING MACHINE



**Technical Specifications:**

- 230V power supply
- acid-resistant stainless steel AISI 304
- temperature control range: 30°-95°C
- Heating power 2x500W,
- dimensions:  
length 590, height 450 mm, width 580 mm (depending on frame type)
- variable width depending on the width of frame
- device dedicated for standard and Hoffman frames, but without spacers

<b>W2091</b>	Vertical manual uncapping machine
<b>W2091S</b>	Vertical manual uncapping machine, with a table 750 mm

# HONEY LOOSENER

The Lyson honey loosener is used for loosening heather honey or similar type of honey. It is made of stainless steel and the machine has two plates with spring loaded needles. The frames of heather are placed between the two plates and the ergonomic lever is pushed to load the needles into the frame,



<b>30281</b>	Honey loosener
--------------	----------------

# UNCAPPING TABLES STANDARD - OPTIMA



Option: wheels available for an additional fee

**Standard uncapping table:**

- Flat bottom
- Height-adjustable table 3 levels
- Bottom drain
- Frame holder
- Perforated sieves on the bottom, collecting uncapped material
- Table cover optional (after additional charge)



UNCAPPING TABLE STANDARD OPTIMA	
<b>W4045</b>	Universal, 500 mm
<b>W4046A</b>	Dadant, 750 mm
<b>W4046C</b>	Dadant, 1000 mm
<b>W4046B</b>	Dadant, 1500 mm
<b>W4042A_DNM</b>	Deutsch Normal, 750 mm
<b>W4042C_DNM</b>	Deutsch Normal, 1000 mm
<b>W4042B_DNM</b>	Deutsch Normal, 1500 mm
<b>W4046A_LN</b>	Langstroth, 750 mm
<b>W4046C_LN</b>	Langstroth, 1000 mm
<b>W4046B_LN</b>	Langstroth, 1500 mm

COVER FOR UNCAPPING TABLE STANDARD OPTIMA	
<b>PZ50</b>	Universal, 500 mm
<b>PZ75D</b>	Dadant, 750 mm
<b>PZ100D</b>	Dadant, 1000 mm
<b>PZ150D</b>	Dadant, 1500 mm
<b>PZ75WL</b>	Deutsch Normal, 750 mm
<b>PZ100WL</b>	Deutsch Normal, 1000 mm
<b>PZ150WL</b>	Deutsch Normal, 1500 mm
<b>PZ75LN</b>	Langstroth, 750 mm
<b>PZ100LN</b>	Langstroth, 1000 mm
<b>PZ150LN</b>	Langstroth, 1500 mm

# UNCAPPING TABLES REINFORCED - OPTIMA

Option: wheels available for an additional fee



Uncapping table, reinforced:

- Trapezoidal bottom
- Height-adjustable table 3 levels
- Bottom drain
- Stand for the uncapped frame
- Perforated sieves on the bottom, collecting uncapped material
- Cover optional (after additional charge)



ANTI-VIBRATION PAD SET OF 4 PCS



UNCAPPING TABLE REINFORCED OPTIMA	
<b>W40460A</b>	Dadant, 750 mm
<b>W40460C</b>	Dadant, 1000 mm
<b>W40460B</b>	Dadant, 1500 mm
<b>W40420A_DNM</b>	Deutsch Normal, 750 mm
<b>W40420C_DNM</b>	Deutsch Normal, 1000 mm
<b>W40420B_DNM</b>	Deutsch Normal, 1500 mm
<b>W40460A_LN</b>	Langstroth, 750 mm
<b>W40460C_LN</b>	Langstroth, 1000 mm
<b>W40460B_LN</b>	Langstroth, 1500 mm

COVER FOR UNCAPPING TABLE REINFORCED OPTIMA OR CLASSIC	
<b>PW75D</b>	Dadant, 750 mm
<b>PW100D</b>	Dadant, 1000 mm
<b>PW150D</b>	Dadant, 1500 mm
<b>PW75WL</b>	Deutsch Normal, 750 mm
<b>PW100WL</b>	Deutsch Normal, 1000 mm
<b>PW150WL</b>	Deutsch Normal, 1500 mm
<b>PW75LN</b>	Langstroth, 750 mm
<b>PW100LN</b>	Langstroth, 1000 mm
<b>PW150LN</b>	Langstroth, 1500 mm

<b>P_AMWS</b>	Anti-vibration pad for reinforced uncapping tables (produced before September 2020) - set of 4 pcs
<b>P_AM3WS</b>	Anti-vibration pad for reinforced uncapping tables (produced after September 2020) - set of 4 pcs

# UNCAPPING TABLE REINFORCED - CLASSIC

ANTI-VIBRATION PAD SET OF 4 PCS



Uncapping table, reinforced:

- Trapezoidal bottom
- Full height-adjustable table
- Bottom drain
- Stand for the uncapped frame
- Perforated sieves on the bottom, collecting uncapped material
- Cover optional (after additional charge) - see above
- Advantageous feature of classic over optima line is additional leg reinforcement stabilizing uncapping table construction

TABLE REINFORCED CLASSIC	
<b>W40460A_CL</b>	Dadant, 750 mm
<b>W40460C_CL</b>	Dadant, 1000 mm
<b>W40460B_CL</b>	Dadant, 1500 mm
<b>W40420A_DNM_CL</b>	Deutsch Normal, 750 mm
<b>W40420C_DNM_CL</b>	Deutsch Normal, 1000 mm
<b>W40420B_DNM_CL</b>	Deutsch Normal, 1500 mm
<b>W40460A_LN_CL</b>	Langstroth, 750 mm
<b>W40460C_LN_CL</b>	Langstroth, 1000 mm
<b>W40460B_LN_CL</b>	Langstroth, 1500 mm

<b>P_AMWS</b>	Anti-vibration pad for reinforced uncapping tables (produced before September 2020) - set of 4 pcs
<b>P_AM3WS</b>	Anti-vibration pad for reinforced uncapping tables (produced after September 2020) - set of 4 pcs

# MULTIFUNCTIONAL UNCAPPING TABLES

## W4037\_AB

Technical data:

- power supply - 230V
- power output - 2.3kW
- heated bottom - 170W
- heated cover - 2000W
- cover fan - 30W
- construction of the table - stainless, acid resistant steel, heated bottom
- construction of the heating cover - acid-resistant stainless steel
- perforated insert along the whole length of the bottom
- adjustable rail width inside the table for different types of frames

- powder coated legs with wheels
- honey drain - stainless steel 6/4" flap valve

Control:

- HC-01 heated bottom temperature controller
- mechanical heating cover controller with capillary

Internal dimensions:

- length - 1000 mm
- width - 500 mm
- height at sides - 425 mm
- height in the middle - 475 mm

Overall height of table without cover:

- 860mm

## W4039\_AB

Technical data:

- power supply - 230V
- power output - 2.3kW
- heated bottom - 170W
- heated cover - 2000W
- cover fan - 30W
- construction of the table - stainless, acid resistant steel, heated bottom, insulated
- construction of the heating cover - acid-resistant stainless steel, insulated, 2 actuators.
- perforated insert along the whole length of the bottom
- adjustable rail width inside the table for stainless steel legs with wheels
- honey drain - stainless steel 6/4" flap valve

Control:

- HC-01 heated bottom temperature controller
- mechanical heating cover controller with capillary

Internal dimensions:

- length - 1000 mm
- width - 515 mm
- height at sides - 400 mm
- height in the middle - 450 mm

Overall height of table without cover:

- 910 mm



W4037\_AB



W4039\_AB

UNCAPPING TABLE REINFORCED 1000 MM	
W4037_AB	Multifunctional uncapping table 1000mm, with heated bottom and heating cover
W4039_AB	Multifunctional insulated uncapping table 1000mm, with heated bottom and hinged insulated heating cover, with actuators

# DURABLE AND HYGIENIC APIARY FURNITURE SYSTEM



Apiary furniture collection is made of acid-resistant stainless steel AISI 304 (1.5 mm thickness). These products offer outstanding durability, corrosion resistance, and ease of cleaning — key benefits for hygienic and long-lasting use in the beekeeping workshop.

All components are designed for quick and easy installation.

Key advantages of the collection:

- high-quality materials: Acid-resistant stainless steel AISI 304 (1.5 mm thick) ensures strength and longevity
- easy maintenance: Smooth surfaces allow for fast and effective cleaning
- modular compatibility: Components can be combined freely within standard apiary setups
- fast setup: Tools designed for intuitive, time-saving assembly

The range includes stainless steel work tables (with or without sinks and taps, in 1200 mm, 1500 mm, and 2000 mm versions), extensions, mobile tables with casters, premium freestanding and wall-mounted cabinets — all tailored to the practical needs of a modern beekeeping facility.



ID	NAME
W920	Stainless steel apiary work table , 1200 mm
W921	Stainless steel apiary work table with sink, 1200 mm
W922	Stainless steel apiary work table with sink and tap, 1200 mm
W923	Stainless steel apiary work table , 1500 mm
W924	Stainless steel apiary work table with sink, 1500 mm
W925	Stainless steel apiary work table with sink and tap, 1500 mm
W926	Stainless steel apiary work table , 2000 mm
W927	Stainless steel apiary work table with sink, 2000 mm
W928	Stainless steel apiary work table with sink and tap, 2000 mm
W929	Stainless steel apiary work table, free-standing, with casters and shelf, 1200 mm
W930	Extension for apiary work table, 1200 mm
W931	Extension for apiary work table, 1500 mm
W932	Extension for apiary work table, 2000 mm
W933_P	Freestanding cabinet for apiary workshop, with drawers, soft close, PREMIUM, 1200 mm
W934_P	Freestanding cabinet for apiary workshop, with double door, soft close, PREMIUM, 1200 mm
W935_P	Hanging cabinet for apiary workshop, with double door, PREMIUM, 1200mm
W919	Stainless steel frame stand

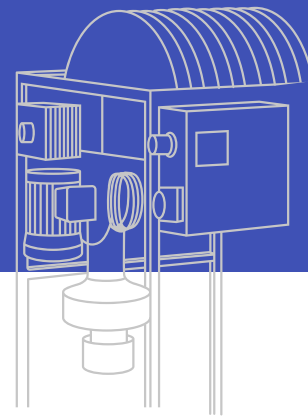

## HONEY DRYERS

The device is used to remove water from the honey. Honey with moisture levels greater than 18% will ferment and is not salable. To prevent spoilage of the fresh honey, excess of water should be removed. Capacitor removes water from honey by using warm air and plates rotating at a speed of up to 9 RPM.

### W4024

- power supply - 230V
- power - 1.65kW:
- 370W motor
- heater 1,200W
- 55W heater fan
- drive: engine 370W, 900 rpm
- stainless steel flap valve 6/4"
- smooth speed control with a potentiometer
- temperature range adjustment

Dimensions:  
length 950 mm,  
width 780 mm,  
height 1220 mm

net weight - 84 kg



W4024



W4021

W4022

### W4021

- Heating power: 1500W / 230V
- Motor: 750W
- Plates diameter: Ø620 mm
- 7,2 RPM
- Dimensions: 1800×1030×1270 mm
- Efficiency to 2% per 10-12h

### W4020

- Heating power: 1200W / 230V
- Motor: 370W
- Plates diameter: Ø620 mm
- 9 RPM
- Dimensions: 1300×1030×1240 mm
- Efficiency: 2-3% per 10-12h

W4024	Honey dryer (with rotating plates), 50 l / ~70 kg
W4020	Honey dryer (with rotating plates), 110 l / ~150 kg
W4021	Honey dryer (with rotating plates), 215 l / ~300 kg
W4022	Option for dryer W4020 or W4021 - condensing aggregate

# TUBULAR FLOW DRYER

Honey drying is to be performed under circumstances when water content in the honey exceeds 18% (when it has been harvested too early or its quality is low).

High water content in honey reduces its shelf life, contributes to its stratification and fermentation even if honey is stored in low temperature.

**Technical parameters:**

- structure - acid-resistant stainless steel AISI 304, maintenance cover made of drainage, metal-plex, thickness 6 mm
- power supply - 230V
- total power - 3,2kW
- pump motor 0,37kW (2 pcs.)
- air heater 1,2kW
- 55W heater fan

**Control:**

Siemens Simatic HMI touch panel that controls the operation of the entire device possibility to work in automatic or manual mode

**Dimensions:**

- height – 2500 mm, width – 650 mm, length – 2300 mm

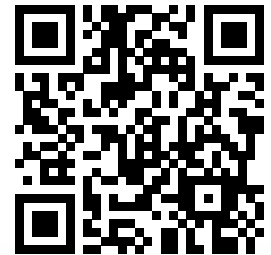
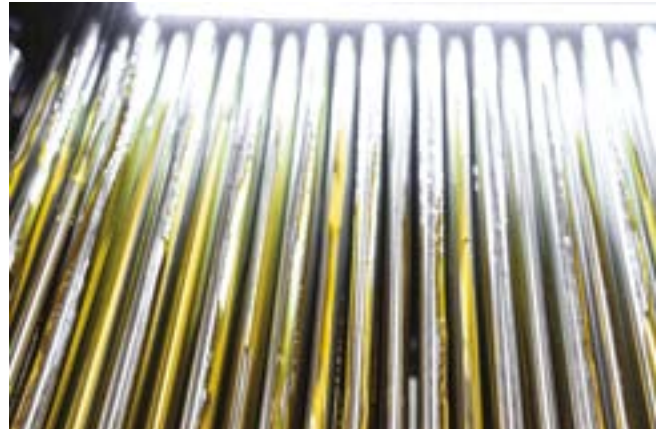

**SCAN AND SEE HOW  
THE HONEY DRYING  
PROCESS LOOKS LIKE!**



<b>W4025</b>	Tubular flow dryer, 230V
--------------	--------------------------

## TUBULAR FLOW DRYER - SMALL VERSION

Once extracted, honey embarks on its journey to achieve the perfect moisture balance. Honey drying, a fascinating blend of art and science, involves reducing the moisture content to prevent fermentation and prolong shelf life. Through controlled air circulation and temperature, we meticulously guide honey towards its optimal state, preserving its rich colour, flavour, and nutritional potency.

### Dimensions and weight:

- height – 1 750 mm
- width – 1 250 mm
- length – 1 300 mm
- net weight – 195 kg

### Technical parameters:

- power supply - 230V / 16A
- total power - 2.7kW
- pump motor - 0,37kW (2 pcs.)
- air heater - 1,2kW
- heater fan - 55W
- hot air blower - 0,68kW
- circulation fan - 4.3W (6 pcs.)
- efficiency – approx 0,5%/hour depending on ambient temperature and type of honey
- structure - acid-resistant stainless steel AISI 304
- top cover and side covers made of metal-plex with a thickness of 4 mm
- diameter of honey pipes - Ø 40 mm
- diameter of air pipes - Ø 100 mm



W4027

Tubular flow dryer - small version, 230V

## ROD DRYER

### Dimensions and weight:

- height – 1 750 mm
- width – 1 250 mm
- length – 1 300 mm
- net weight – 195 kg

### Technical parameters:

- power supply - 230V / 16A
- total power - 2.7kW
- pump motor - 0,37kW (2 pcs.)
- air heater - 1,2kW
- heater fan - 55W
- hot air blower - 0,68kW
- circulation fan - 4.3W (6 pcs.)
- efficiency – approx 0,5%/hour depending on ambient temperature and type of honey
- structure - acid-resistant stainless steel AISI 304
- top cover and side covers made of metal-plex with a thickness of 4 mm
- diameter of honey pipes - Ø 40 mm
- diameter of air pipes - Ø 100 mm



W4023

Rod honey dryer, 230V

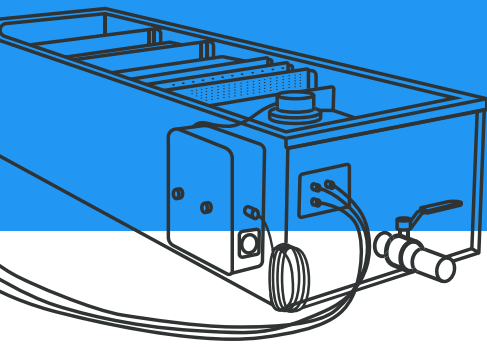

The honey level sensor is not included in the kit

## HONEY SUMPS

Four-chamber sump is used to filter the honey flowing directly from the honey extractor during spinning. It is equipped with strainers made of perforated stainless steel mesh of varying diameters that allow for precise filtering of the flowing honey. It is suitable to work with a pump. Vertical strainer can be additionally equipped with heat system that helps to get better filtered honey. For extra charge we can provide a float switch, which by working with a honey pump, controls the level of honey in the strainer and automatically starts and stops the pump.

<b>W2084</b>	Honey sump, 1000 mm
<b>W2082A</b>	Honey sump, 1500 mm
<b>W2081A</b>	Honey sump, heated, 1000 mm
<b>W2081</b>	Honey sump, heated, 1500 mm
<b>W2086</b>	Stainless steel sieve insert, Ø3 mm mesh, for heated honey sump

Specifications:

- Length: 1000 or 1500 mm
- Number of chambers: 4 pieces
- Number of sieves (405 × 295 mm): 5 pieces (3 pieces: 3 mm mesh diameter, 2 pieces: mesh diameter of 1 mm)
- Number of drains: 1× 6/4" 2 piece
- Type of valve: ball
- Power supply: 230V/50Hz
- Temperature regulation between: 30-55°C
- Heating power in W2081A and W2081: 230V/440W (length 1000 mm), 230 V/520W (length: 1500 mm)



External dimensions:

- Honey sump 1000 mm:  
length: 1140 mm, width: 510 mm, height: 350 mm
- Honey sump 1500 mm:  
length: 1640 mm, width: 510 mm, height: 350 mm

Internal dimensions:

- Honey sump 1000 mm:  
length: 1000 mm, width: 410 mm, height: 300 mm
- Honey sump 1500 mm:  
length: 1500 mm, width: 410 mm, height: 300 mm

## CASCADE HONEY SIEVE WITH COVER AND ELECTRONIC HONEY LEVEL SENSOR



Specifications:

- acid-resistant stainless steel sheet
- thickness - 1 mm
- power supply - 230V/50Hz
- total heating power 1040W:
- two plate heaters in the middle partitions: 300W each
- heating cable on side walls and bottom: 440W
- temperature regulator MHC-01 3 pcs.
- temperature control range - 30-55°C
- honey level sensor
- sieve lid
- external dimensions :
- length. 1600, width 710, height 350 mm
- internal dimensions:
- length 1500, width 400, height 300 mm
- number of drains - 1 x 6/4" spigot
- weight - 62.00 kg
- packing dimensions:
- length 1650, width 760, height 400 mm

<b>W2079</b>	Cascade honey sieve with cover, with electronic honey level sensor
--------------	--

# VERTICAL SIEVE ON THE BASE OF STAINLESS SETTLING TANK 50 L

Specifications W2001:

- acid-resistant stainless steel
- dimensions: Ø 400 mm, height 440 mm
- number of drains: 2 × 6/4" (flap valve)
- number of sieves: 2 (mesh diameters 1 mm and 3 mm)

<b>W2001</b>	Vertical sieve on the base of stainless settling tank 50 l / ~70 kg
--------------	---



# HONEY FILTER ON THE BARREL

A honey filter designed to be mounted directly on a 200-liter barrel. A 0.37 kW pump with a flow rate of 900 liters per hour is an ideal solution for transferring honey through the filter. A built-in level sensor monitors the honey level in the barrel to prevent dry running and ensure continuous, safe operation. The setup is perfect for beekeepers looking for an efficient and clean filtering solution.

Operational Manual:

Connect the hose to the cover and the pump that feeds honey into the tank (you can change the pump tip included in the kit). Attach the hose to the pump on the tank and put the other end into an extra tank.

Assemble everything and start filtering. After filtering, you can connect the hose from the pump back to the cover and rinse with warm water once the tank is full.

<b>W370</b>	Honey filter on the base of barrel 200 l / ~280 kg, with pump 400V / 0,37kW
-------------	---



- Specifications:
- Barrel's capacity: 200 l,
  - Pump's power: 0,37kW
  - Efficiency: 900 l/h
  - Honey level sensor

# HONEY FILTER



Consists of 2 stainless steel pipes, acid – resistant, with the diameter of 48 mm (6/4”). The vertical pipe is finished with the connector that enables easy filter-to-pump hose insertion. The horizontal pipe is equipped with 4 nozzles with the diameter of 42 mm (5/4”) with ball valves and flexible sieves. The entire set rests on 4 legs with adjustable spacing for easy fitting onto all types of uncapping tables (the table is not a part of the device - to be purchased separately). Each of these 4 filters can be switched on or off by turning the appropriate valve. It is useful during the cleaning of each filter. The filter can be fitted onto 1000 or 1500 mm tables.

All components are made of acid-resistant stainless steel. The device is user-friendly, easy to transport and clean as the required elements are easily dismantable.

<b>W360</b>	Honey filter (without uncapping table)
<b>FILTER_W360</b>	Honey filter for W360, nylon





Function	C-01	C-03 PREMIUM	C05
<b>Stirrer operating time</b>	Adjustable 5 to 15 minutes	Adjustable 5 to 15 minutes	Adjustable 5 to 15 minutes
<b>Stirrer standstill time</b>	Adjustable 45 to 90 minutes	Adjustable 45 to 480 minutes	Adjustable 45 to 480 minutes
<b>Total creaming time</b>	Continuous, adjustable: 1h, 24h, 36h, 48h, 60h, 72h, 84h, 96h, 99h	Adjustable 1 to 99 hours	Adjustable 1 to 99 hours
<b>Stirrer speed adjustment</b>	NO	YES	YES
<b>Diagnostics</b>	YES	YES	YES
<b>Full diagnostics (Inverter fault detection)</b>	NO	NO	YES
<b>Operating hours counter</b>	NO	NO	YES
<b>Display</b>	YES	YES	YES
<b>Display contrast adjustment</b>	NO	NO	YES
<b>Power supply</b>	3x400V	230V	230V

## HONEY CREAMING MACHINES 400V

Capacity l (kg)	Diameter	Tank height	Total height	Sheet thickness drum/bottom	Motor power	Controller	Mixer speed	Valve
50 l (-70 kg)	400 mm	435 mm	650 mm	0,6 mm	180W	C-01	36 rpm	Stainless 6/4"
70 l (-100 kg)	400 mm	615 mm	830 mm	0,6 mm	220W	C-01	36 rpm	Stainless 6/4"
100 l (-140 kg)	500 mm	615 mm	830 mm	0,6/0,8 mm	550W	C-01	36 rpm	Stainless 6/4"
150 l (-210 kg)	500 mm	815 mm	1020 mm	0,6/0,8 mm	1100W	C-01	36 rpm	Stainless 2"
200 l (-280 kg)	600 mm	735 mm	945 mm	0,6/0,8 mm	1100W	C-01	36 rpm	Stainless 2"

## HONEY CREAMING MACHINES 230V

Capacity l (kg)	Diameter	Tank height	Total height	Sheet thickness drum/bottom	Motor power	Controller	Mixer speed	Valve
50 l (-70 kg)	400 mm	435 mm	680 mm	0,6 mm	180W	C-05	0-36 rpm	Stainless 6/4"
70 l (-100 kg)	400 mm	615 mm	860 mm	0,6 mm	220W	C-05	0-36 rpm	Stainless 6/4"
100 l (-140 kg)	500 mm	615 mm	860 mm	0,6/0,8 mm	550W	C-05	0-36 rpm	Stainless 6/4"
150 l (-210 kg)	500 mm	815 mm	1075 mm	0,6/0,8 mm	1100W	C-05	0-36 rpm	Stainless 2"
200 l (-280 kg)	600 mm	735 mm	1000 mm	0,6/0,8 mm	1100W	C-05	0-36 rpm	Stainless 2"

## HONEY CREAMING MACHINES WITH HEATING JACKET 400V

Capacity l (kg)	Diameter	Tank height	Total height	Sheet thickness drum/bottom	Motor power	Controller	Mixer speed	Valve
50 l (-70 kg)	400/500 mm	490 mm	720 mm	0,6/0,8 mm	180W	C-01	36 rpm	Stainless steel 6/4"
70 l (-100 kg)	400/500 mm	665 mm	890 mm	0,6/0,8 mm	220W	C-01	36 rpm	Stainless steel 6/4"
100 l (-140 kg)	500/600 mm	665 mm	890 mm	0,8/0,8 mm	550W	C-01	36 rpm	Stainless steel 6/4"
150 l (-210 kg)	500/600 mm	865 mm	1105 mm	0,8/0,8 mm	1100W	C-01	36 rpm	Stainless 2"
200 l (-280 kg)	600/700 mm	790 mm	1025 mm	0,8/0,8 mm	1100W	C-01	36 rpm	Stainless 2"
600 l (-840 kg)	800/900 mm	1510 mm	1800 mm	1,0/1,5 mm	4000W	C-01	36 rpm	Stainless 2"

## HONEY CREAMING MACHINES WITH HEATING JACKET 230V

Capacity l (kg)	Diameter	Tank height	Total height	Sheet thickness drum/bottom	Motor power	Controller	Mixer speed	Valve
50 l (-70 kg)	400/500 mm	490 mm	750 mm	0,6/0,8 mm	180W	C-05	0-36 rpm	Stainless 6/4"
70 l (-100 kg)	400/500 mm	665 mm	920 mm	0,6/0,8 mm	220W	C-05	0-36 rpm	Stainless 6/4"
100 l (-140 kg)	500/600 mm	665 mm	920 mm	0,8/0,8 mm	550W	C-05	0-36 rpm	Stainless 6/4"
150 l (-210 kg)	500/600 mm	865 mm	1160 mm	0,8/0,8 mm	1100W	C-05	0-36 rpm	Stainless 2"
200 l (-280 kg)	600/700 mm	790 mm	1080 mm	0,8/0,8 mm	1100W	C-05	0-36 rpm	Stainless 2"

## HONEY CREAMING MACHINES WITHOUT HEATING JACKET PREMIUM LINE

Capacity l (kg)	Diameter	Tank height	Total height	Sheet thickness drum/bottom	Motor power	Controller	Mixer speed	Valve
50 l (-70 kg)	400 mm	435 mm	680 mm	0,8 mm	220W	C-03	36 rpm	Stainless 6/4"
70 l (-100 kg)	400 mm	615 mm	860 mm	0,8 mm	370W	C-03	36 rpm	Stainless 6/4"
100 l (-140 kg)	500 mm	615 mm	860 mm	0,8 mm	750W	C-03	36 rpm	Stainless 6/4"
150 l (-210 kg)	500 mm	815 mm	1075 mm	0,8 mm	1500W	C-03	36 rpm	Stainless 2"
200 l (-280 kg)	600 mm	735 mm	1000 mm	0,8 mm	1500W	C-03	36 rpm	Stainless 2"

## HONEY CREAMING MACHINES WITH HEATING JACKET PREMIUM LINE

Capacity l (kg)	Diameter	Tank height	Total height	Sheet thickness drum/bottom	Motor power	Controller	Mixer speed	Valve
50 l (-70 kg)	400/500 mm	490 mm	750 mm	0,8 mm	220W	C-03	36 rpm	Stainless 6/4"
70 l (-100 kg)	400/500 mm	665 mm	920 mm	0,8 mm	370W	C-03	36 rpm	Stainless 6/4"
100 l (-140 kg)	500/600 mm	665 mm	920 mm	0,8 mm	750W	C-03	36 rpm	Stainless 6/4"
150 l (-210 kg)	500/600 mm	865 mm	1160 mm	0,8 mm	1500W	C-03	36 rpm	Stainless 2"
200 l (-280 kg)	600/700 mm	790 mm	1080 mm	0,8 mm	1500W	C-03	36 rpm	Stainless 2"



STAINLESS STEEL  
AISI 316



STAINLESS ACID-RESISTANT STEEL  
AISI 304



THE DEVICE MEETS THE LEGAL  
REQUIREMENTS APPLICABLE IN THE EU



IMPORTANT  
INFORMATION

These devices are designed for honey creaming. Construction of the mixing blade (made of stainless steel) allows creaming honey precisely. Honey creaming consists of inoculation of liquid honey with crystallized honey and abrasion of the honey crystals using a low rotational speed. The creaming process should run in "work-break" cycles (1 hour break for every 15 minutes of creaming). Good creamed honey should have consistence similar to butter.

Automatic control for honey creaming or creaming-decrystallization machines with power supply 400V or 230V.

## CREAMING MACHINES 400V



CREAMING MACHINE	
<b>W20088</b>	50 l / ~70 kg, 400V, with automatic controller - CLASSIC
<b>W20088A</b>	70 l / ~100 kg, 400V, with automatic controller - CLASSIC
<b>W20080NT</b>	100 l / ~140 kg, 400V, with automatic controller - CLASSIC
<b>W20080B</b>	150 l / ~210 kg, 400V, with automatic controller - CLASSIC
<b>W20080C</b>	200 l / ~280 kg, 400V, with automatic controller - CLASSIC

capacity	diameter	drum height	total height	drum thickness	motor power	controller	rotation of mixer	valve
50 l (~70 kg)	400 mm	435 mm	650 mm	0,6 mm	0,18kW	C-01	36 RPM	Stainless 6/4"
70 l (~100 kg)	400 mm	615 mm	830 mm	0,6 mm	0,22kW	C-01	36 RPM	Stainless 6/4"
100 l (~140 kg)	500 mm	615 mm	830 mm	0,6/0,8 mm	0,55kW	C-01	36 RPM	Stainless 6/4"
150 l (~210 kg)	500 mm	815 mm	1020 mm	0,6/0,8 mm	1,1kW	C-01	36 RPM	Stainless 2"
200 l (~280 kg)	600 mm	735 mm	945 mm	0,6/0,8 mm	1,1kW	C-01	36 RPM	Stainless 2"

## CREAMING MACHINES 230V



CREAMING MACHINE	
<b>W20088_Z</b>	50 l / ~70 kg, 230V, with automatic controller - CLASSIC
<b>W20088A_Z</b>	70 l / ~100 kg, 230V, with automatic controller - CLASSIC
<b>W20080NT_Z</b>	100 l / ~140 kg, 230V, with automatic controller - CLASSIC
<b>W20080B_Z</b>	150 l / ~210 kg, 230V, with automatic controller - CLASSIC
<b>W20080C_Z</b>	200 l / ~280 kg, 230V, with automatic controller - CLASSIC

capacity	diameter	drum height	total height	drum thickness	motor power	controller	rotation of mixer	valve
50 l (~70 kg)	400 mm	435 mm	680 mm	0,6 mm	0,18kW	C-05	36 RPM	Stainless 6/4"
70 l (~100 kg)	400 mm	615 mm	860 mm	0,6 mm	0,22kW	C-05	36 RPM	Stainless 6/4"
100 l (~140 kg)	500 mm	615 mm	860 mm	0,6/0,8 mm	0,55kW	C-05	36 RPM	Stainless 6/4"
150 l (~210 kg)	500 mm	815 mm	1075 mm	0,6/0,8 mm	1,1kW	C-05	36 RPM	Stainless 2"
200 l (~280 kg)	600 mm	735 mm	1000 mm	0,6/0,8 mm	1,1kW	C-05	36 RPM	Stainless 2"

# CREAMING AND DECRYSTALLIZATION MACHINES 400V



CREAMING AND DECRYSTALLIZATION MACHINE	
<b>W20087</b>	50 l / ~70 kg, 400V, with automatic controller - CLASSIC
<b>W20087C</b>	70 l / ~100 kg, 400V, with automatic controller - CLASSIC
<b>W20085</b>	100 l / ~140 kg, 400V, with automatic controller - CLASSIC
<b>W20086</b>	150 l / ~210 kg, 400V, with automatic controller - CLASSIC
<b>W20089</b>	200 l / ~280 kg, 400V, with automatic controller - CLASSIC
<b>W200890</b>	600 l / ~840 kg, 400V, with automatic controller - CLASSIC

capacity	diameter	drum height	total height	drum thickness	motor power	controller	rotation of mixer	valve
50 l (~70 kg)	400/500 mm	490 mm	720 mm	0,6/0,8 mm	0,18kW	C-01	36 RPM	Stainless 6/4"
70 l (~100 kg)	400/500 mm	665 mm	890 mm	0,6/0,8 mm	0,22kW	C-01	36 RPM	Stainless 6/4"
100 l (~140 kg)	500/600 mm	665 mm	890 mm	0,6/0,8 mm	0,55kW	C-01	36 RPM	Stainless 6/4"
150 l (~210 kg)	500/600 mm	865 mm	1105 mm	0,6/0,8 mm	1,1kW	C-01	36 RPM	Stainless 2"
200 l (~280 kg)	600/700 mm	790 mm	1025 mm	0,6/0,8 mm	1,1kW	C-01	36 RPM	Stainless 2"
600 l / ~840 kg	800/900 mm	1510 mm	1800 mm	1,0/1,5 mm	4kW	C-01	36 RPM	Stainless 2"

# CREAMING AND DECRYSTALLIZATION MACHINES 230V



CREAMING AND DECRYSTALLIZATION MACHINE	
<b>W20087_Z</b>	50 l / ~70 kg, 230V, with automatic controller - CLASSIC
<b>W20087C_Z</b>	70 l / ~100 kg, 230V, with automatic controller - CLASSIC
<b>W20085_Z</b>	100 l / ~140 kg, 230V, with automatic controller - CLASSIC
<b>W20086_Z</b>	150 l / ~210 kg, 230V, with automatic controller - CLASSIC
<b>W20089_Z</b>	200 l / ~280 kg, 230V, with automatic controller - CLASSIC

capacity	diameter	drum height	total height	drum thickness	motor power	controller	rotation of mixer	valve
50 l (~70 kg)	400/500 mm	490 mm	750 mm	0,6/0,8 mm	0,18kW	C-05	36 RPM	Stainless 6/4"
70 l (~100 kg)	400/500 mm	665 mm	920 mm	0,6/0,8 mm	0,22kW	C-05	36 RPM	Stainless 6/4"
100 l (~140 kg)	500/600 mm	665 mm	920 mm	0,6/0,8 mm	0,55kW	C-05	36 RPM	Stainless 6/4"
150 l (~210 kg)	500/600 mm	865 mm	1160 mm	0,6/0,8 mm	1,1kW	C-05	36 RPM	Stainless 2"
200 l (~280 kg)	600/700 mm	790 mm	1080 mm	0,6/0,8 mm	1,1kW	C-05	36 RPM	Stainless 2"

# CREAMING MACHINES 230V



PREMIUM line



CREAMING MACHINE	
W20088_ZP	50 l / ~70 kg, 230V, with automatic controller - PREMIUM
W20088A_ZP	70 l / ~100 kg, 230V, with automatic controller - PREMIUM
W20080NT_ZP	100 l / ~140 kg, 230V, with automatic controller - PREMIUM
W20080B_ZP	150 l / ~210 kg, 230V, with automatic controller - PREMIUM
W20080C_ZP	200 l / ~280 kg, 230V, with automatic controller - PREMIUM

capacity	diameter	drum height	total height	drum thickness	motor power	controller	rotation of mixer	valve
50 l (~70 kg)	400 mm	435 mm	680 mm	0,6/0,8 mm	0,22kW	C-03	36 RPM	Stainless 6/4"
70 l (~100 kg)	400 mm	615 mm	860 mm	0,6/0,8 mm	0,37kW	C-03	36 RPM	Stainless 6/4"
100 l (~140 kg)	500 mm	615 mm	860 mm	0,8 mm	0,75kW	C-03	36 RPM	Stainless 6/4"
150 l (~210 kg)	500 mm	815 mm	1075 mm	0,8 mm	1,5kW	C-03	36 RPM	Stainless 2"
200 l (~280 kg)	600 mm	735 mm	1000 mm	0,8 mm	1,5kW	C-03	36 RPM	Stainless 2"

# CREAMING AND DECRYSTALLIZATION MACHINES 230V



PREMIUM line



CREAMING AND DECRYSTALLIZATION MACHINE	
W20087_ZP	50 l / ~70 kg, 230V, with automatic controller - PREMIUM
W20087C_ZP	70 l / ~100 kg, 230V, with automatic controller - PREMIUM
W20085_ZP	100 l / ~140 kg, 230V, with automatic controller - PREMIUM
W20086_ZP	150 l / ~210 kg, 230V, with automatic controller - PREMIUM
W20089_ZP	200 l / ~280 kg, 230V, with automatic controller - PREMIUM

capacity	diameter	drum height	total height	drum thickness	motor power	controller	rotation of mixer	valve
50 l (~70 kg)	400/500 mm	490 mm	750 mm	0,8 mm	0,22kW	C-03	36 RPM	Stainless 6/4"
70 l (~100 kg)	400/500 mm	665 mm	920 mm	0,8 mm	0,37kW	C-03	36 RPM	Stainless 6/4"
100 l (~140 kg)	500/600 mm	665 mm	920 mm	0,8 mm	0,75kW	C-03	36 RPM	Stainless 6/4"
150 l (~210 kg)	500/600 mm	865 mm	1160 mm	0,8 mm	1,5kW	C-03	36 RPM	Stainless 2"
200 l (~280 kg)	600/700 mm	790 mm	1080 mm	0,8 mm	1,5kW	C-03	36 RPM	Stainless 2"

# CREAMING DEVICES ON PAILS



<b>W200401</b>	Device for creaming honey on plastic pail 17,7 l / ~25 kg, 230V - OPTIMA
<b>W200400</b>	Device for creaming honey on plastic pail 31,5 l / ~44 kg, 230V - OPTIMA

capacity	diameter	drum height	total height	drum thickness	motor power	controller	rotation of mixer	valve
17,7 l / ~25 kg	310 mm	275 mm	425 mm	-	0,18kW	-	36 RPM	-
31,5 l / ~44 kg	360 mm	375 mm	525 mm	-	0,18kW	-	36 RPM	-

# TRANSPORTING TROLLEYS FOR SETTLING TANKS / CREAMING MACHINES



W6066



W6606\_L

ID	NAME
<b>W6604</b>	Transporting trolley for settling tanks / creaming machines 50 l, 70 l without heating jacket
<b>W6605</b>	Transporting trolley for settling tanks / creaming machines 100 l, 150 l (without heating jacket), 50 l, 70 l (with heating jacket)
<b>W6606</b>	Transporting trolley for settling tanks / creaming machines 200 l (without heating jacket), 100 l, 150 l (with heating jacket)
<b>W6607</b>	Transporting trolley for settling tanks / creaming machines 300 l (without heating jacket), 200 l (with heating jacket)
<b>W6604_L</b>	Transporting trolley for settling tanks/creamig machines 50l, 70l (without heating jacket), regulated - NEW
<b>W6605_L</b>	Transporting trolley for settling tanks/creamig machines 100l, 150l (without heating jacket), 50l, 70l (with heating jacket), regulated - NEW
<b>W6606_L</b>	Transporting trolley for settling tanks/creamig machines 200l (without heating jacket), 100l, 150l (with heating jacket), regulated - NEW
<b>W6607_L</b>	Transporting trolley for settling tanks/creamig machines 300l (without heating jacket), 200l (with heating jacket), regulated - NEW

# STANDS FOR CREAMING MACHINES

Height: 290 mm

ANTI-VIBRATION PAD SET



ID	NAME
<b>W32050N</b>	Stainless stand for creaming machine 30 l, 50 l or 70 l
<b>W32060N</b>	Stainless stand for creaming machine 100 l, 150 l
<b>W3206N</b>	Stainless stand for creaming machine 200 l
<b>W320600N</b>	Stainless stand for creaming machine 300 l
<b>W32060P</b>	Stainless stand for creaming and decrystallization machine 30 l, 50 l or 70 l
<b>W3206P</b>	Stainless stand for creaming and decrystallization machine 100 l, 150 l
<b>W320600P</b>	Stainless stand for creaming and decrystallization machine 200 l
<b>P_AMON</b>	Anti-vibration pad for stands for settling tanks - set of 3 pcs

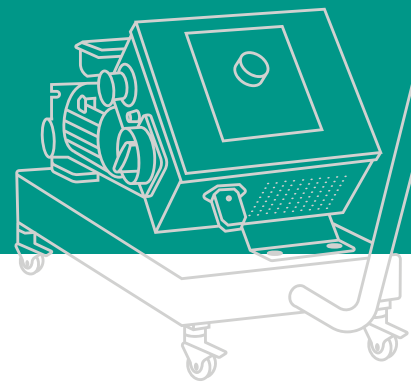

## HONEY PUMP COMPACT VERSION

Specifications:

- Power supply: 400V
- Motor power: 0,37kW
- Efficiency: 900l/h
- Quick couplings for Ø 40mm hose
- Dimensions:  
length: 350, width: 250,  
height: 350 mm
- net weight - 12,3 kg



Specifications:

- Power supply: 230V
- Motor power: 0,37kW
- Efficiency: 900l/h
- Quick couplings for Ø 40mm hose
- Dimensions:  
length: 350, width: 250,  
height: 350 mm
- net weight - 12,3 kg

## HONEY PUMP COMPACT VERSION

Characteristics:

- power supply - 400V
- engine - 0.55kW
- efficiency -1 650 l/h
- quick couplings for Ø 40mm hose
- dimensions: length 350,  
width 250, height 350 mm
- net weight - 12.3 kg

- compact structure
- casing easy to carry
- gear module - easy disassembly for cleaning
- tests have shown that the pump can feed honey to a height of about 7 m

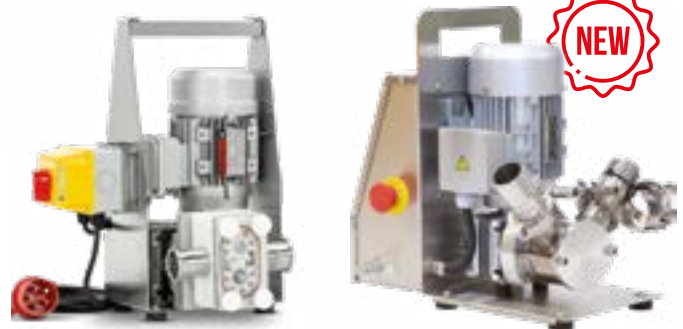

<b>W2021G400</b>	Honey pump (suction and force pump) 400V / 0,37kW - compact version
<b>W2021G230</b>	Honey pump (suction and force pump) 230V / 0,37kW - compact version

ID	NAME
<b>W2022NZ</b>	Honey pump 400V / 0,55kW - compact version
<b>W2022NZ230</b>	Honey pump 230V / 0,55kW - compact version

## VERTICAL AUGER PUMP

Equipment designed especially for pumping honey out of barrels or tanks with no drain outlets. Made entirely of stainless steel and food grade synthetic material.

Specifications:

- Motor power 2,2kW
- Power supply 400V
- Efficiency varies from 1500 l/h to 3000 l/h
- Rotation: 2800 RPM
- Ability to connect a 5/4" hose - Ø 40mm
- crossbar-stand included

<b>W20210S</b>	Vertical auger honey pump 400V / 2,2kW
----------------	--



# HONEY PUMPS, 400V

<b>W2021GN</b>	Honey pump (suction and force pump) 400V / 0,37kW
<b>W20210GN</b>	Honey pump (suction and force pump) 400V / 1,5kW

Dual purpose suction and force pump:

- Efficiency with honey temperature of 30°C:
  - 0,37kW - 900 l/h,
  - 1,5kW - 1500 l/h
- Power supply: 400V
- Quick release coupling for hose:
  - 0,37kW - Ø40 mm,
  - 1,5kW - Ø50 mm



The hose is not included in the pump kit.

# HONEY PUMPS, 230V

<b>W2021GNF</b>	Honey pump (suction and force pump) 230V / 0,37kW (with inverter)
<b>W20210GNF</b>	Honey pump (suction and force pump) 230V / 1,5kW (with inverter)

Dual purpose suction and force pump:

- Efficiency with honey temperature of 30°C:
  - 0,37kW - 900 l/h,
  - 1,5kW - 1500 l/h
- Power supply: 230V
- Quick release coupling to pump:
  - 0,37kW - Ø40 mm,
  - 1,5kW - Ø50 mm

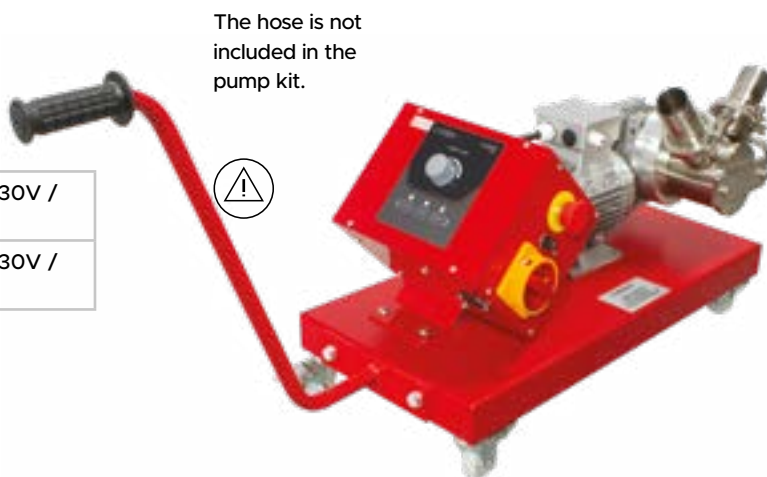

The hose is not included in the pump kit.

# HOSE SUPPORT



HOSE SUPPORTS	
<b>W32600</b>	Stainless pipe handle Ø40 mm
<b>W32601</b>	Stainless pipe handle Ø50 mm
<b>W32600_50</b>	Stainless handle for pipe Ø40 mm for settling tanks - wall thickness up to 50 mm
<b>W32601_50</b>	Stainless handle for pipe Ø50 mm for settling tanks - wall thickness up to 50 mm

# HONEY SUMP FLOAT SWITCHES

The sensors allow to control level of honey in the tank. Mechanical sensor - starts the pump, when the max level is reached and stops at the low level



# PUMP HOSES

PUMP HOSES	
<b>5023</b>	Pump hose Ø40 mm (1 meter)
<b>5024</b>	Pump hose Ø50 mm (1 meter)
<b>5025</b>	Pump hose Ø60 mm (1 meter)

<b>W4107</b>	Mechanical honey level sensor, 400V
<b>W4105</b>	Mechanical honey level sensor, 230V

# HONEY SETTLING TANKS



## STAINLESS STEEL TANKS

**PREMIUM  
line**

The tanks are made of acid resistant stainless steel. Characteristic feature of the tanks is the conical shaped bottom which allows for effective and hassle free emptying. Tanks are equipped with integrated stainless steel stands, and a matching covers. Tanks are available in four equipment variants. Brushed steel outer surface.

Tanks 1000 are equipped with level indicator.



### STAINLESS STEEL TANKS - PREMIUM

<b>W852</b>	500 l / ~700 kg, with stainless cover and integrated stand - PREMIUM
<b>W852P</b>	500 l / ~700 kg, with stainless cover, integrated stand and heating system - PREMIUM
<b>W852M</b>	500 l / ~700 kg, with acrylic glass cover, stirrer and integrated stand - PREMIUM
<b>W852MP</b>	500 l / ~700 kg, with acrylic glass cover, stirrer, integrated stand and heating system - PREMIUM
<b>W853</b>	1000 l / ~1400 kg, with stainless cover and integrated stand - PREMIUM
<b>W853P</b>	1000 l / ~1400 kg, with stainless cover, integrated stand and heating system - PREMIUM
<b>W853M</b>	1000 l / ~1400 kg, with acrylic glass cover, stirrer and integrated stand - PREMIUM
<b>W853MP</b>	1000 l / ~1400 kg, with acrylic glass cover, stirrer, integrated stand and heating system - PREMIUM



### STAINLESS STEEL TANKS & STANDS

<b>W856</b>	Stainless steel settling tank 500 kg with a 2" stainless ball valve
<b>W857</b>	Stainless steel settling tank 750 kg with a 2" stainless ball valve
<b>W858</b>	Stainless steel settling tank 1000 kg with a 2" stainless ball valve
<b>W859</b>	Stainless steel settling tank 1250 kg with a 2" stainless ball valve
<b>W0856</b>	Stand for 500 kg settling tank
<b>W0857</b>	Stand for 800 kg settling tank
<b>W0858_9</b>	Stand for 1000-1250 kg settling tank

# WATER- JACKETED STAINLESS STEEL SETTling TANKS

1. Venting cap
2. Electric heater with temperature regulator
3. Oil drain valve / service valve
4. Wax drain valve
5. Temperature gauge



W7057MK



WATER - JACKETED STAINLESS STEEL SETTling TANK	
W7056	70 l / ~100 kg, heated, with stainless valve 5/4" and handles
W7056MK	70 l / ~100 kg, heated, with stainless valve 5/4", handles and module for creaming honey, 400V
W7057	150 l / ~210 kg, heated, with stainless valve 5/4" and handles
W7057MK	150 l / ~210 kg, heated, with stainless valve 5/4", handles and module for creaming honey, 400V

Specifications:

- Heater power 2000W
- Power supply 230V
- Temperature range 0-75°C
- Drain valve 5/4"
- Handles

W7056

Dimensions:

- Tank: 400×450×707 mm (Ø internal, Ø external, height)
- Set: 570×660×730 mm (Ø internal, Ø external, height)

W7057

Dimensions:

- Tank: 500×550×862 mm (Ø internal, Ø external, height)
- Set: 670×760×887 mm (Ø internal, Ø external, height)

## TRANSPARENT SETTling TANK 29L

Honey settling tank with heated stainless steel bottom and certified PMMA XT walls. Equipped with a honey gate and temperature controller to maintain constant honey temperature. Keeps honey liquid and ready for direct sale from the beekeeper or stores.



Specifications:

- Supply voltage 230V
- Power 150W
- Temperature range 30 - 55°C
- capacity 29L / 40kg
- Stainless steel stand, coating made of transparent tube PMMA XT
- Diameter 250 mm, height 700 mm

W5020	Honey settling tank 29 l / ~40 kg with transparent jacket, heated
-------	---

## BARREL 200L

- Diameter: 568 mm
- Height: 890 mm
- Made of stainless, acid-resistant steel with a thickness of 1 mm
- Lid closure with additional stainless steel band, bolted with two screws



W7016	Stainless steel barrel 200 l / ~280 kg
W7016A	Stainless steel barrel 200 l / ~280 kg, with a stainless valve 2"

## BARREL PIPE

The pipe must be firmly attached to the barrel walls with the provided grip. Made of acid-resistant stainless steel with two replaceable hose adaptors: Ø50 and Ø40 mm.



W202	Honey pumping pipe
------	--------------------

# PARAMETERS OF STAINLESS SETTLING TANKS

Capacity l (kg)	Diameter	Sheet thickness	Height	Valve
30 l (-40 kg)	400 mm	0,6 mm	310 mm	Stainless 6/4"
50 l (-70 kg)	400 mm	0,6 mm	440 mm	Stainless 6/4"
70 l (-100 kg)	400 mm	0,6 mm	615 mm	Stainless 6/4"
100 l (-140 kg)	500 mm	0,6 mm	615 mm	Stainless 6/4"
150 l (-210 kg)	500 mm	0,6 mm	815 mm	Stainless 2"
200 l (-280 kg)	600 mm	0,6 mm	750 mm	Stainless 2"
300 l (-420 kg)	650 mm	0,8 mm	1000 mm	Stainless 2"

**CLASSIC**  
line



Capacity l (kg)	Diameter	Sheet thickness	Height	Valve
30 l (-40 kg)	400 mm	0,6 mm	460 mm	Stainless 6/4"
50 l (-70 kg)	400 mm	0,6 mm	592 mm	Stainless 6/4"
70 l (-100 kg)	400 mm	0,6 mm	765 mm	Stainless 6/4"
100 l (-140 kg)	500 mm	0,6 mm	780 mm	Stainless 6/4"
150 l (-210 kg)	500 mm	0,6 mm	995 mm	Stainless 2"
200 l (-280 kg)	600 mm	0,6 mm	920 mm	Stainless 2"

**PREMIUM**  
line



## SETTLING TANKS CLASSIC LINE

- New, more durable cover
- New handles covered with PVC for more secure carrying
- New screw for easier valve closure



**CLASSIC**  
line



ID	NAME	Height/Diameter
<b>W711</b>	Stainless steel settling tank 30 l / -40 kg, 6/4" stainless steel valve, handles - CLASSIC	310mm / 400mm
<b>W712</b>	Stainless steel settling tank 50 l / -70 kg, 6/4" stainless steel valve, handles - CLASSIC	440mm / 400mm
<b>W713</b>	Stainless steel settling tank 70 l / -100 kg, 6/4" stainless steel valve, handles - CLASSIC	615mm / 400 mm
<b>W714</b>	Stainless steel settling tank 100 l / ~140 kg, 6/4" stainless steel valve, handles - CLASSIC	615mm / 500mm
<b>W715</b>	Stainless steel settling tank 150 l / ~210 kg, 2" stainless steel valve, handles - CLASSIC	815mm / 500mm
<b>W716</b>	Stainless steel settling tank 200 l / ~280 kg, 2" stainless steel valve, handles - CLASSIC	750mm / 600mm
<b>W717</b>	Stainless steel settling tank 300 l / ~420 kg, 2" stainless steel valve, handles - CLASSIC	1000mm / 650mm

# SETTLING TANKS - NEW LINE!

**CLASSIC**  
line

Settling tanks play a key role in any apiary. The honey clarification process allows for the natural separation of impurities and air bubbles after the honey has been extracted. As a result, honey not only gains clarity, but also improves its taste, which is particularly important both when selling honey and its further use, e.g. in the production of mead.

Designed for hobbyists and professional beekeepers alike, the new CLASSIC line of settling tanks is a response to the growing demands on honey quality as well as to the diverse needs of the world.

Advantages of the new line of settling tanks:

- rimmed cover, which improves not only the visual aspect, but also the rigidity of the element;
  - safety clamps and siliconized edges of the lid, thanks to which the risk of moving or opening is eliminated;
  - ergonomic handles that increase comfort of use
- Made of high-quality stainless steel, they offer exceptional durability and resistance to damage and corrosion, making them an ideal solution for long-term honey storage. The silicone gasket is a guarantee of protecting honey against moisture absorption, as well as contamination from the outside. The latest CLASSIC settling tanks are adapted to the diverse needs of beekeepers, ensuring effective and safe storage of honey at every stage of its production.

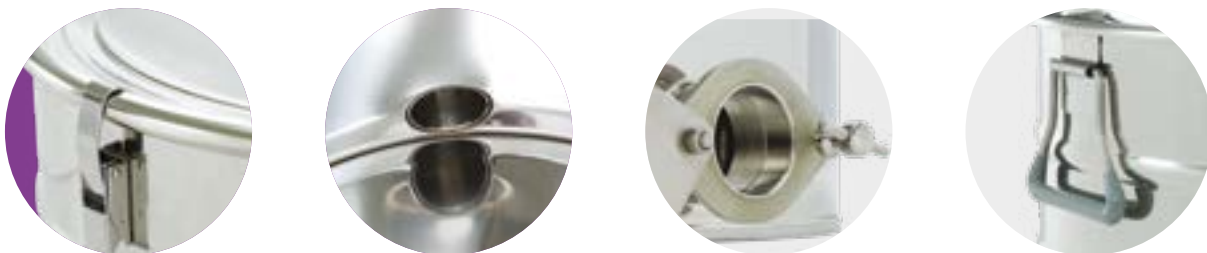

ID	NAME	Height/Diameter
W711_K	Stainless steel settling tank 30 l / ~40 kg, 6/4" stainless steel valve, handles, clamps, gasket - CLASSIC	310mm / 400mm
W712_K	Stainless steel settling tank 50 l / ~70 kg, 6/4" stainless steel valve, handles, clamps, gasket - CLASSIC	440mm / 400mm
W713_K	Stainless steel settling tank 70 l / ~100 kg, 6/4" stainless steel valve, handles, clamps, gasket - CLASSIC	615mm / 400 mm
W714_K	Stainless steel settling tank 100 l / ~140 kg, 6/4" stainless steel valve, handles, clamps, gasket - CLASSIC	615mm / 500mm
W715_K	Stainless steel settling tank 150 l / ~210 kg, 2" stainless steel valve, handles, clamps, gasket - CLASSIC	815mm / 500mm
W716_K	Stainless steel settling tank 200 l / ~280 kg, 2" stainless steel valve, handles, clamps, gasket - CLASSIC	750mm / 600mm
W717_K	Stainless steel settling tank 300 l / ~420 kg, 2" stainless steel valve, handles, clamps, gasket - CLASSIC	1000mm / 650mm

# SETTLING TANKS PREMIUM LINE



“Premium Line” settling tanks consist of: a drum, a conical bottom and a drainpipe in the bottom. They are made of polished stainless steel with 0,6 mm thickness. The thickness of the bottom is 0,8 mm. The pipe is connected to the wall of the stand. The honey gate is screwed to this pipe. Settling tanks are equipped with stainless steel cover with rubber seal secured with clasps.

STAINLESS STEEL SETTLING TANKS WITH CONICAL BOTTOM - PREMIUM	
<b>W71P</b>	30 l / ~40 kg, with a stainless valve 6/4”, with handles, with conical bottom - PREMIUM
<b>W72P</b>	50 l / ~70 kg, with a stainless valve 6/4”, with handles, with conical bottom - PREMIUM
<b>W73P</b>	70 l / ~100 kg, with a stainless valve 6/4”, with handles, with conical bottom - PREMIUM
<b>W74P</b>	100 l / ~140 kg, with a stainless valve 6/4”, with handles, with conical bottom - PREMIUM
<b>W75P</b>	150 l / ~210 kg, with a stainless valve 2”, with handles, with conical bottom - PREMIUM
<b>W76P</b>	200 l / ~280 kg, with a stainless valve 2”, with handles, with conical bottom - PREMIUM



# STAINLESS STEEL SETTLING TANK WITH CONICAL SIEVE



<b>W7030</b>	Stainless steel settling tank 70 l / ~100 kg, handles, additional drain valve and conical sieve
<b>W7031</b>	Stainless steel settling tank 100 l / ~140 kg, with handles, additional drain valve and conical sieve
<b>W7042</b>	Stainless steel settling tank 50 l / ~70 kg, with handles, additional drain valve and conical sieve
<b>W7043</b>	Stainless steel settling tank 150 l / ~210 kg, with handles, additional drain valve and conical sieve



# STAINLESS STEEL SETTLING TANKS WITH HEATED DRUM AND CONICAL BOTTOM - PREMIUM



STAINLESS STEEL SETTLING TANKS WITH HEATED DRUM AND CONICAL BOTTOM - PREMIUM	
<b>4043A_P</b>	50 l / ~70 kg, with a stainless valve 6/4”, heated, 230V
<b>4043D_P</b>	70 l / ~100 kg, with a stainless valve 6/4”, heated, 230V
<b>4043C_P</b>	100 l / ~140 kg, with a stainless valve 6/4”, heated, 230V
<b>4043E_P</b>	150 l / ~210 kg, with a stainless valve 2”, heated, 230V
<b>4043B_P</b>	200 l / ~280 kg, with a stainless valve 2”, heated, 230V



# SETTLING TANKS WITH HEATED DRUM



SETTLING TANKS WITH HEATED DRUM	
<b>4043A</b>	50 l / ~70 kg, with a stainless valve 6/4", heated, 230V
<b>4043D</b>	70 l / ~100 kg, with a stainless valve 6/4", heated, 230V
<b>4043C</b>	100 l / ~140 kg, with a stainless valve 6/4", heated, 230V
<b>4043E</b>	150 l / ~210 kg, with a stainless valve 2", heated, 230V
<b>4043B</b>	200 l / ~280 kg, with a stainless valve 2", heated, 230V
<b>W32060P</b>	Stainless stand for creaming and decrystallization machine 30 l, 50 l or 70 l
<b>W3206P</b>	Stainless stand for creaming and decrystallization machine 100 l, 150 l
<b>W320600P</b>	Stainless stand for creaming and decrystallization machine 200 l

# STAINLESS STEEL SYRUP MIXER

## W0136

Technical specifications and dimensions:

- Capacity: 200 litres (~280 kg)
- Power supply: 230V
- Gear motor 0.22 kW
- Agitator speed control: Yes
- Operating temperature range: 20 - 85°C
- Heating power: 3000W
- Drum diameter: 650 mm
- Sheet thickness: 1,5 mm
- Height: 1000 mm
- Lid: 5 mm plexiglas
- Valve: ball valve, stainless steel, size 5/4", distance from ground 160 mm
- Weight: 110 kg

## W0137

Technical specifications and dimensions:

- Capacity: 400 litres (~560 kg)
- Power supply: 230V / 400V
- Gear motor 0.55 kW
- Agitator speed control: Yes
- Operating temperature range: 30 - 80°C
- Heating power: 6000W
- Drum diameter: 770 mm
- Sheet thickness: 1,5 mm
- Height: 1290 mm
- Lid: 5 mm plexiglas
- Valve: ball valve, stainless steel, size 5/4", distance from ground 150 mm
- Weight: 155 kg



<b>W0136</b>	Stainless steel syrup mixer, capacity 200l (~280 kg)
<b>W0137</b>	Stainless steel syrup mixer, capacity 400l (~560 kg)



<b>W856M</b>	Stainless steel syrup mixer, capacity 500 kg (drive 400V)
<b>W856MP</b>	Stainless steel syrup mixer with heating jacket, capacity 500 kg, (heating 230V, drive 400V)
<b>W858M</b>	Stainless steel syrup mixer, capacity 1000 kg (drive 400V)
<b>W858MP</b>	Stainless steel syrup mixer with heating jacket, capacity 1000 kg, (heating 230V, drive 400V)
<b>W0856M</b>	Stainless stand for syrup mixer, capacity 500 kg (drive 400V)
<b>W0856MP</b>	Stainless stand for syrup mixer with heating jacket, capacity 500 kg, (heating 230V, drive 400V)
<b>W0858M</b>	Stainless stand for syrup mixer, capacity 1000 kg (drive 400V)
<b>W0858MP</b>	Stainless stand for syrup mixer with heating jacket, capacity 1000 kg, (heating 230V, drive 400V)

## MANUAL BOTTLING VALVES



Specifications:

- Stainless valve, with flange 5/4", 6/4", 2"
- Stainless handle with support



A settling tank is sold separately.

<b>W4010</b>	Stainless manual bottling valve 5/4" or 6/4"
<b>W4010Z</b>	Stainless manual bottling valve 2"

## PNEUMATIC VALVES



Specifications:

- Cone valve, with flange 5/4", 6/4", 2"
- Pneumatic actuator
- Air connecting cables
- Air foot pedal
- Air connection valve



A settling tank is sold separately.

<b>W4011</b>	Stainless steel pneumatic valve 5/4" or 6/4"
<b>W4011Z</b>	Stainless steel pneumatic valve 2"

## STANDS FOR SETTLING TANKS



**ANTI-VIBRATION PAD SET**



Height: 290 mm

STAINLESS STEEL STANDS	
<b>W32050N</b>	for settling tanks 30 l, 50 l or 70 l
<b>W32060N</b>	for settling tanks 100 l, 150 l
<b>W3206N</b>	for settling tanks 200 l
<b>W320600N</b>	for settling tanks 300 l
<b>P_AMON</b>	Anti-vibration pad - set of 3 pcs

## SIEVES



STAINLESS STEEL SIEVES	
<b>W7022</b>	for honey settling tanks 30 l, 50 l or 70 l
<b>W7021</b>	for honey settling tanks 100 l, 150 l
<b>W7020</b>	for honey settling tanks 200 l
<b>W7023</b>	for honey settling tanks 300 l
<b>W7025</b>	Stainless steel, conical sieve for settling tank 50 l - 70 l
<b>W7026</b>	Stainless steel, conical sieve for settling tank 100 l - 150 l

## HEAT MELTER/COVER

Specifications:

- Power supply 230V
- Heater power 1kW
- Suitable for 150 L settling tanks
- Temperature range 30-120°C
- Material thickness 0,8 mm

A settling tank is sold separately.



<b>W5010</b>	Heat melter / cover with basket (for stainless settling tanks 100 l, 150 l)
--------------	---

## STAND

Stand for settling tanks with an extra shelf for jars. The solution enables easy and comfortable honey bottling.

A settling tank is sold separately.



<b>LP4004</b>	Stand for settling tanks and jars
---------------	-----------------------------------

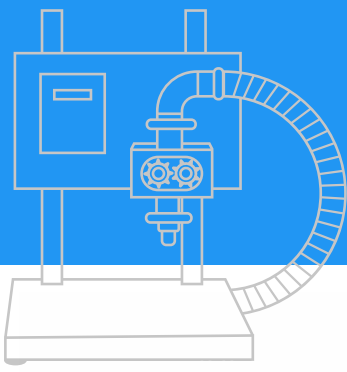

## AUTOMATIC HONEY BOTTLING LINE - CLASSIC



- The line consists of:
- 2 turn tables of 900 mm diameter.
  - Honey bottler unit
  - 2000 mm conveyor belt for jar filling

The device has been designed to be used by single person. The conveyor belt stops automatically when the jar is directly under the filling nozzle. Filling range from 250g to 1250g.

**W204004** Automatic honey dosing line - CLASSIC

- Specifications:
- Total length: 3,8 m
  - Each element has a separate controller
  - Table power: 120W/pc
  - Dispenser power: 270W
  - Both turntables and bottler are made of acid-resistant stainless steel
  - The whole line is fitted onto a rack equipped with wheels for easy moving

## LABELING MODULE FOR AUTOMATIC BOTTLING LINE

**The photo and technical parameters are for illustrative purposes only – the product may be modified depending on the customer's needs. The product is priced individually and manufactured to order.**

Module dedicated for W204004 honey bottling line. Automatic labeling machine is designated for automatic application of self-adhesive labels, significantly simplifying work process with labeling of filled jars.

Device was designed to work with jars of capacity from 250 g to 1250 g. Labeler is equipped with modern microprocessor controller, photoelectric sensor, responsible for positioning of jars and optical sensor, responsible for positioning of labels. Labeling efficiency depends on dispenser speed.

The main features of the labeling machine are:

- Jar conveyor with adjustable speed
- Side guides for jars with adjustable spacing
- Label feeder driven by a step motor
- Pneumatic jar separator
- Labeling of jars with capacities from 250g to 1250g



**W4086**

- Technical specifications:
- Supported labels: self-adhesive
  - Maximum label height: 120 mm
  - Outer diameter of the label roll: 240 mm
  - Inner roll diameter: 40–76 mm
  - Work pressure: 2–4 bar
  - Label guides: stainless steel, aluminum-polyurethane with bearings
  - Power supply: 230V / 50Hz

## HEATED TANK

### Specifications:

- Power supply: 230V
- Heater power: 440W

Heated tank, designed for maintaining an adequate temperature of honey during the filling of the jars. The device is equipped with a 5/4 inch ball valve and an electronic level sensor which stops the pump after reaching a certain level.



**W7052**

Tank 100 l / ~140 kg, heated, with stand, for W204004 (Automatic honey dosing line - CLASSIC)

## DUAL CHAMBER HEATED TANK

### Specifications:

- Power supply: 230V
- Heater power: 500W

Dual-chamber heated tank designed for maintaining an adequate temperature of honey during honey bottling. It consists of two separate chambers, 150 l each. The device is equipped with two 6/4 inch ball valves and an electronic level sensor which stops the pump after reaching a preset level. By using directional valve, chambers can be filled with different types of honey (pictured tank with two valves).



**W7051**

Tank 300 l / ~420 kg, dual chamber, heated, for W204004 (Automatic honey dosing line - CLASSIC)

# MANUAL HONEY DISPENSER

Technical data and product advantages:

- made of stainless, acid-resistant steel OH18N9
- maximum jar dimensions: Ø 70 mm / height 120 mm
- adjustable stand for jars of different heights
- bottler dosing: max to capacity 150 ml
- dimensions of the manual bottler: length 320, width 270, height 710 mm
- tank volume: 14 dm<sup>3</sup>
- weight: 16.5 kg

**W2045**

Manual honey bottler (for capacity up to 150 ml)



# HONEY BOTTLER WITH BUILT-IN SCALE

Technical specifications:

- contact panel control
- electric height adjustment of dispensing module from 100 mm to 200 mm
- automatic jar taring before each dispensing
- pumping option
- type of dosing module: gear
- drive: electric
- power supply: 230V
- power: 180W
- minimum jar height: 100mm
- maximum jar height: 186mm
- minimum jar diameter: 40mm
- maximum jar diameter: 110mm
- filling range: 10g-9000g
- capacity (\* depending on density and type of honey) [500g jars / h]: 400 pcs.

The bottler does not require pre-calibration.



**W204006**

Honey bottler with built-in scale

# HONEY BOTTLER OPTIMA LINE

- Power supply: 230V/100W
- Self-priming, low speed pump with gear module improved durability thanks to gear module
- All the parts which has direct contact with honey are made of stainless steel and plastic approved for contact with food
- Fills around 350 jars 500g per hour (depends on the condensity of honey)
- Filling accuracy: up to 1200 g +/- 1% above 1200 g +/- 1,5 %
- Filling range – from 50 g to 11 kg
- Dimensions: 420×380×480 mm (L×W×H)
- Weight – 15 kg



**W204001O**

Honey bottler with stand, 230V - OPTIMA

# HONEY BOTTLERS



The honey bottler set consists of:  
honey bottler unit, foot switch, hose pipe 1.5 m, quick hose connector pump, hose clamp



W204001Z



W204003Z



W204001



W204003

Main features:

- Low speed pump with silicone impeller (W204001, W204003)
- Low speed pump with a gear module (W204001Z, W204003Z)
- Digitally controlled
- Fills about 350 jars of 500 g per hour (depending on the type and density of honey) (W204001, W204003).
- Fills about 400 jars of 500 g per hour (depending on the type and density of honey) (W204001Z, W204003Z).
- Filling accuracy: up to 1200g +/- 1%, above 1200g +/- 1.5%
- Filling range from 50 g to 45 kg
- Can be used as a pump (after disassembling the nozzle)
- All parts that have a direct contact with honey are made of stainless steel or plastic approved for food contact
- Power supply: 230V / 180W

HONEY BOTTLER	
W204001	Honey bottler with stand, 230V - CLASSIC
W204003	Honey bottler with stand, 230V - PREMIUM
W204001Z	Honey bottler (with gear module) with stand, 230V - CLASSIC
W204003Z	Honey bottler (with gear module) with stand, 230V - PREMIUM

## HONEY BOTTLERS WITH MINI TURNTABLE

Its compact size and advanced design allows to speed up the honey bottling process even in the smaller workshop. Designed to be used by single person.

- Dimensions: width: 81cm, base width: 50cm, height: 63,5cm
- Turntable diameter: 60cm

W204012	Mini turntable Ø 600 mm
W204013	Honey bottler with mini turntable Ø 600 mm - CLASSIC
W204013Z	Honey bottler (with gear module) with mini turntable Ø 600 mm - CLASSIC



# HONEY BOTTLERS WITH AUTOMATIC TURNTABLE

**CLASSIC**  
line



**PREMIUM**  
line



This automatic turntable consists of:

- Table base: height-adjustable base allows for the regulation of the dispensing device's height, it is equipped with wheels
- Turntable made of stainless steel: The table top is divided by jars guide - into two parts. The first part is for the empty jars to fill in; the second part is for filled jars,
- The controller regulates speed of the table

Technical parameters of the table:

- Ø of the top 90 cm
- Height: 82 cm
- dimensions and volume of the fill up jars:  
min. Ø 3 cm and 4,5 cm height, min. Ø 15 cm and 30 cm height
- Power supply: 230V / 180W

<b>W204010</b>	Automatic turntable Ø 900 mm for honey bottler W204001 (Honey bottler, 230V, with stand - CLASSIC)
<b>W204002</b>	Honey bottler with automatic turntable Ø 900 mm - CLASSIC
<b>W204002P</b>	Honey bottler with automatic turntable Ø 900 mm - PREMIUM
<b>W204002Z</b>	Honey bottler (with gear module) with automatic turntable Ø 900 mm - CLASSIC
<b>W204002PZ</b>	Honey bottler (with gear module) with automatic turntable Ø 900 mm - PREMIUM

## DISPENSING NOZZLES



- Nozzle made of stainless steel (OH18N9).
- Weight: 0.6 kg
- M38x1.5 connection thread identical to the nozzle mounted as standard to the bottler.
- Nozzle equipped with a membrane that prevents honey from dripping during breaks during bottler's operation.
- Membrane made of EPDM.

<b>59900033</b>	Dispensing nozzle for honey bottlers with gear module
<b>W340010</b>	Check valve - dedicated bottlers equipment

# HONEY DECRYSTALLIZATION

## DECRYSTALLIZATION



Warming cabinets are devices used for honey decrystallization, that is for changing the set of honey turning solid (crystallized) honey into liquid. Equipped with heating element and blower fan, which allows for better heat distribution inside the cabinet. Digital temperature controller protects honey from overheating.

### W204100

Specifications:

- Capacity: 90 l (18 jars 900ml)
- Power: 100W
- Temperature range: 30-55°C
- Internal dimensions: 380×540×340 (W×H×D)
- External dimensions: 550×810×440 mm (W×H×D)

### W204100A

Specifications:

- Capacity: 490 l
- Power: 1000W
- Temperature range: 30-55°C
- Internal dimensions: 690×1010×740 mm (W×H×D)
- External dimensions: 875×1205×865 mm (W×H×D)



W204100A

W204100	Warming cabinet, capacity 90 l
W204100A	Warming cabinet, capacity 490 l

Electronic temperature controller

The electronic temperature controller is equipped with a 7-segment LED display for an easy temperature reading. Temperature control is in the range of 30-55 degrees Celsius and measurement accuracy +/- 1.5°C. Temperature reading is rounded to the decimal point of the Celsius degree. The running time of the basic controller is 1 to 96 hours after which the unit switches off. The controller has a built-in preheating function for 0-60 minutes and a temperature of 30-40 degrees Celsius. After the preheat mode is completed, the controller switches to the basic operating mode. Operation of the controller and heating element is signaled by two LEDs (orange and red).

## WARMING CABINET FOR ONE BARREL 300 KG

### W40780

Specifications:

- Capacity: barrel 300 kg
- Power: 2000W
- Temperature range: 30-55°C
- Internal dimensions: 910×1210×1300 mm (W×H×D)
- External dimensions: 1135×1290×1535 mm (W×H×D)

### W40781

Specifications:

- Capacity: pallet 120x120 cm
- Power: 2000W
- Temperature range: 30-55°C
- Internal dimensions: 1310×1160×1300 mm (W×H×D)
- External dimensions: 1520×1235×1535 (W×H×D)



W40780	Warming cabinet for one barrel 215 l / ~300 kg
W40781	Warming cabinet for pallet with one barrel 215 l / ~300 kg



# CONICAL HEATING SPIRAL



The sieve and the stand are not included in the set.

**Technical data:**

- the device is made of acid-resistant stainless steel
- power supply: 230V
- heating power 50W
- maximum temperature: 45°C
- dimensions:  
length: 380 mm,  
width: 200 mm,  
height: 380 mm
- weight: 1.25 kg



<b>W32010</b>	Conical heating spiral Ø 200 mm, 50W
<b>3222</b>	Conical strainer Ø29,5 cm
<b>W3221</b>	Stand for conical strainer for sieve ID 3222A and 3069

# HEATING COILS OPTIMA LINE

**Heating coil:**

- 3 sizes:
- Ø250 mm - 800W 230V
- Ø330 mm - 1000W 230V
- Ø480 mm - 1600W 230V
- Temperature range, up to 90°C



<b>W3207_OL</b>	Heating coil Ø 250 mm, 800W - OPTIMA
<b>W3208_OL</b>	Heating coil Ø 330 mm, 1000W - OPTIMA
<b>W3210_OL</b>	Heating coil Ø 480 mm, 1600W - OPTIMA

# HEATING COILS CLASSIC LINE

**W3207, W3208, W3210**

**Technical data:**

- Power supply: 230V
- Temperature range: 30–80°C

	Coil diameter	Maximum immersion depth of the heating element	Total height
<b>W3207</b>	250 mm	840 mm	1100 mm
<b>W3208</b>	330 mm	840 mm	1100 mm
<b>W3210</b>	480 mm	900 mm	1100 mm



<b>W3207</b>	Heating coil Ø 250 mm, 800W - CLASSIC
<b>W3208</b>	Heating coil Ø 330 mm, 1000W - CLASSIC
<b>W3210</b>	Heating coil Ø 480 mm, 1600W - CLASSIC

## STAND FOR HEATING COIL

### W3500101

Stand for Heating coil 250 - 480 mm

#### Components:

- leg - rod Ø15 - 3 pcs.
- vertical tube Ø48 mm - - length 550 mm with knob - 1 pc.
- stand tube Ø42 mm - - length 750 mm - 1 pc.
- tube connector - 1 pc.
- horizontal tube Ø42 mm - length 400 mm with clamp - 1 pc.

### W3500101

Stand for heating coil Ø 250-480 mm



## HIVE BODY HEATER

Made of stainless steel, can be used to warm up hive bodies if there is no heating in the workshop.

Heater can be used with 12-frame Dadant bodies, Langstroth and DN. It is also suitable for other hive bodies if adapter inserts are used. Before uncapping and extruding, hive bodies should be placed on the heater for several hours. Warm air is distributed between frames and is warming them up to facilitate easier uncapping and extracting.

#### Technical parameters:

- Power supply 230V
- Power 150W
- Temperature range 30 - 55°C
- Heater is constructed from multi layer board and reinforced with stainless steel
- Dimensions:  
650×470×260 mm



### W3012

Hive body heater, 300W

## ELECTRONIC TEMPERATURE CONTROLLER

The electronic temperature controller is mounted in heated devices (warming cabinets, heating coils classic, hive body heater, settling tanks, honey sumps, creaming machines, pollen dryer).

It is equipped with a 7-segment LED display for an easy temperature reading. Temperature range 30-80°C depending on the equipment. Temperature reading is rounded to the decimal point of the Celsius degree. The running time of the basic controller is 1 to 96 hours after which time the unit switches off. The controller has a built-in preheating function for 0-60 minutes and a temperature of 30-40 degrees Celsius. After the preheat mode is completed, the controller switches to the basic operating mode. Operation of the controller and heating element is signaled by two LEDs (orange and red).



# 3. WAX MELTING



# WAX MELTERS



This device is intended for the wax recovery from frames or dried material using steam. It consists of external tank, with water and basket for frames or dried material. Additional equipment consists of a gas stool, which heats the water tank to generate steam.

User's manual of wax melters W4075 and W4076:

1. Fill the tank with water to the drain pipe level
2. Fill the basket with frames or dried honeycombs
3. Cover the device with lid
4. Place the gas stool under the device in such way that it heats the whole bottom surface
5. Wait until the steam is generated and the melted wax flows through the drain pipe
6. After the melting is done, check the water level and top it up if needed.
7. Fill the basket with frames or dried honeycombs
8. Repeat the points 6 and 7 until the melting is finished
9. After melting is finished turn the gas stool off and close the gas cylinder
10. Clean the basket and prepare it for the next use

## WAX MELTER

Must be used with gas reducer.



**Number of frames fitting into the basket:**  
10/14 Dadant frames (normal/hoffman)

<b>W4076</b>	Stainless wax melter (medium large) + gas stool
<b>OPCJA_TD</b>	OPTION: Sealing ring for W4076 (Stainless wax melter (medium large))
<b>P_AMWO</b>	Anti-vibration pad for wax melters - set of 4 pcs

Specifications:

- Material: stainless steel,
- total height: 800 mm
- FREE OF CHARGE: Gas stool with thermocouple
- Power supply: LPG

Tank dimensions:

- length: 580 mm,
- width: 420 mm,
- height: 600 mm,
- drain diameter: 1"

Frame basket dimensions:

- length: 525 mm,
- width: 370 mm,
- height: 420 mm

## WAX MELTER



**Number of frames fitting into the basket:**  
8/11 Dadant frames (normal/hoffman)

<b>W4075</b>	Stainless wax melter (small) + gas stool
<b>OPCJA_TM</b>	OPTION: Sealing ring for W4075 (Stainless wax melter (small))

Specifications:

- Material: stainless steel,
- total height: 820 mm

Tank dimensions:

- length: 515 mm,
- width: 360 mm,
- height: 495 mm,
- drain diameter: 1"

Frame basket dimensions:

- length: 455 mm,
- width: 285 mm,
- height: 305 mm



Free of charge: gas burner 9300W with thermocouple, supply: propane-butane



# WAX MELTER INSULATED

**Number of frames fitting into the basket:**

10/15 Dadant frames (normal/hoffman)

<b>W4076O</b>	Stainless wax melter (medium large), insulated + gas stool
<b>P_AMWO</b>	Anti-vibration pad for wax melters - set of 4 pcs

Designed for wax recovery from frames or drought using a steam method. It consists of an external tank (with water in it) and the frame or drought accomodating basket. It is equipped with insulated sides and cover to eliminate energy loss.

It comes with a 7kW gas stool to heat the water tank.

**Specifications:**

- Material: stainless steel

**Frame basket dimensions:**

- length: 450 mm,
- width: 375 mm,
- height: 430 mm

**External tank dimensions:**

- length: 585 mm,
- width: 515 mm,
- height: 615 mm (with legs - 808 mm)
- drain diameter: 1"



Free of charge: gas burner 9300W



# WAX MELTER WITH WATER SEALING

Devices may be used outside or in well-ventilated rooms. Gas pressure reducer not included



<b>W4075UW</b>	Stainless wax melter (small), water seal + gas stool
<b>W4076UW</b>	Stainless wax melter (medium large), water seal + gas stool

**Tank dimensions (LxWxH):**

- W4076UW: 580x420x600 mm
- W4075UW: 515x360x495 mm

**Frame basket dimensions (LxWxH):**

- W4076UW: 5530x375x440 mm
- W4075UW: 445x290x330 mm



Free of charge: gas burner 9300W

# WAX MELTER

**Number of frames fitting into the basket:**

24/34 Dadant frames (normal/hoffman)

<b>W4070</b>	Stainless wax melter (large) + gas stool
<b>P_AMWO</b>	Anti-vibration pad for wax melters - set of 4 pcs

**Material:**

- Acid stainless steel
- Steel thickness 0,8mm, bottom 1 mm
- diameter of the trigger -1"

**Dimensions of the tank:**

- length – 1050 mm
- width – 620 mm
- height – 940 mm



**The dimensions of the basket for frames:**

- length – 870 mm
- width – 455 mm
- height – 430 mm
- Weight– 35 kg

## WAX MELTER

### Number of frames fitting into the basket:

84/117 Dadant frames (normal/hoffman)



Free of charge: gas burner 9300W with thermocouple, supply: propane-butane

<b>W4072</b>	Stainless wax melter (extra large) + gas stool
<b>REDB</b>	Adaptor for gas cylinder to stainless wax melter

### Tank dimensions:

- external height: 830 mm
- external width and length: 1154 mm × 1154 mm

### Frame basket dimensions:

- height: 410 mm
- width and length: 1000 mm × 1000 mm

### Specifications:

- Material: stainless steel
- Power supply (of the gas stool): LPG
- drain diameter: 40 mm: 2 pcs
- water drain diameter: 25 mm

### Additional equipment (after extra charge)

- wheels,
- gas stool



## WAX MELTER INSULATED



Free of charge: gas burner 9300W with thermocouple, supply: propane-butane

### Number of frames fitting into the basket:

84/117 Dadant frames (normal/hoffman)

Designed for wax recovery from frames or drought using a steam method. It consists of an external tank (for water) and the frame or drought accommodating basket. It is equipped with insulated sides to eliminate energy loss. It comes with a 7,5kW gas stool to heat the water tank.

<b>W4072_O</b>	Stainless wax melter (extra large), insulated + gas stool
<b>REDB</b>	Adaptor for gas cylinder to stainless wax melter

- Basket dimensions for frames: 990×990×410 mm
- Gas stool free
- External dimensions: 1165×1165×825 mm



## WAX MELTER WITH STEAM GENERATOR

### Note:

The steam generator may differ from the one shown in the photo.

<b>W5030</b>	Wax melter based on stainless settling tank 70 l (Ø400 mm), perforated basket + steam generator
<b>2059</b>	Steam generator



### Technical specifications:

- Heater power: 2000W,
- Power supply : 230V,
- Water tank capacity 4 l,
- Warming up time 10 min,
- Hose length 3,5 m
- Stand and tray included

# WAX MELTER ON THE BASE OF STAINLESS SETTLING TANKS

3 types of product available:

- ECO without steam generator,
- ECO with steam generator
- PREMIUM with perforated basket and gas stool



W4097P



W4097W

WAX MELTER ON THE BASE OF STAINLESS SETTLING TANK	
W4097	100 l (Ø500 mm), without a steam generator - eco version
W4097W	100 l (Ø500 mm) + steam generator - eco version
W4097P	100 l (Ø500 mm), perforated basket + gas stool
W4096	200 l (Ø600 mm), without a steam generator - eco version
W4096W	200 l (Ø600 mm) + steam generator - eco version
W4096P	200 l (Ø600 mm), perforated basket + gas stool

Note:

The steam generator may differ from the one shown in the photo.

Technical parameters:

- Acid stainless steel
- steel thickness cover/bottom 0,6mm / 0,8mm
- connectors - 2"
- cover
- perforated, stainless, acid-proof contribution with a sieve
- tray

100 l wax melter:

- diameter – Ø520 mm
- high – 630 mm

200 l wax melter:

- diameter – Ø630 mm
- high – 750 mm

# WAX MELTER ON THE BASE OF POLIPROPYLENE PAIL



W4077	Wax melter based on polipropylene pail 31,5 l + steam generator
W253	Stainless steel basket for W4077 (Wax melter based on polipropylene pail 31,5 l)

This device is designed to recover the wax from bee frames or dried material using a steam method.

Device consists of:

- Polypropylene pail, cap. 33 l
- Stainless steel basket, cap. 20 l
- Metal stand
- Tray for melted wax
- Steam generator: Power supply 230V, Power 2000W, Water capacity 4 l

Note:

The steam generator may differ from the one shown in the photo.

# WAX MELTER WITH WATER GRATE



W4081	Wax melter with water grate
-------	-----------------------------

Specifications:

- acid resistant stainless steel body
- power supply – 400V/32A
- tank heater – 4,5kW
- grating heater – 7,5kW
- tank's water jacket temperature range: 30-45°C
- grating temperature range 30-90°C
- external dimensions: 1800×880×1000mm (L×W×H)
- weight: 145 kg.

# WAX MELTERS COMBINED WITH UNCAPPING TABLE

<b>W4074</b>	Steam wax melter combined with uncapping table 1000 mm in one
<b>W4074A</b>	Steam wax melter combined with uncapping table 1500 mm in one

**Material:**

- Acid stainless steel
  - Power supply – 400V
  - The heating power of the steam generator - 6kW
  - Number of triggers - internal thread 6/4"
  - Steel thickness 0,8 mm
- Uncapping table:**
  - Sieve
  - Cover
  - Stand for uncapping frames table width reducing rail (max. Frame width 470 mm)



# HEATING COVERS FOR UNCAPPING TABLES



- Heating cover for uncapping table.
- Power supply: 230V,
- Heating power: 1,5kW (for melter 1000 mm) and 3kW (for melter 1500 mm)
- Temperature controller

**Note:**

When placing your order, please specify which table (standard or reinforced) the heating melter will be used with.

HEATING COVER FOR STANDARD UNCAPPING TABLE	
<b>PG100D</b>	Dadant 1000 mm - OPTIMA
<b>PG150D</b>	Dadant 1500 mm - OPTIMA
<b>PG100WL</b>	Deutsch Normal 1000 mm - OPTIMA
<b>PG150WL</b>	Deutsch Normal 1500 mm - OPTIMA
<b>PG100LN</b>	Langstroth 1000 mm - OPTIMA
<b>PG150LN</b>	Langstroth 1500 mm - OPTIMA

HEATING COVER FOR REINFORCED UNCAPPING TABLE	
<b>PG100D_W</b>	Dadant 1000 mm - OPTIMA or CLASSIC
<b>PG150D_W</b>	Dadant 1500 mm - OPTIMA or CLASSIC
<b>PG100WL_W</b>	Deutsch Normal 1000 mm - OPTIMA or CLASSIC
<b>PG150WL_W</b>	Deutsch Normal 1500 mm - OPTIMA or CLASSIC
<b>PG100LN_W</b>	Langstroth 1000 mm - OPTIMA or CLASSIC
<b>PG150LN_W</b>	Langstroth 1500 mm - OPTIMA or CLASSIC

# HOT WATER WAX MELTER



**W7053\_230V**

- Technical parameters:**
- Acid-resistant stainless steel
  - Power supply – 230V/16A
  - Heating power - 2,8kW
  - Water drain valve – 1"
  - Wax drain valve – 1"
  - Temperature range 30-95°C
  - Capacity 100 l
  - Ø outside tank - 600 mm
  - Ø Int. tank - 500 mm
- Dimensions:**
- Int. height 595 mm
  - Out height 650 mm
  - weight – 26 kg

**W7053**

- Technical parameters:**
- Acid-resistant stainless steel
  - Power supply – 3x400V/16A
  - Heating power - 3,5kW
  - Water drain valve – 1"
  - Wax drain valve – 1"
  - Temperature range 30-95°C
  - Capacity 100 l
  - Ø outside tank - 600 mm
  - Ø Int. tank - 500 mm
- Dimensions:**
- Int. height 595 mm
  - Out height 650 mm
  - weight – 26 kg

<b>W7053</b>	Hot water wax melter, 100 l, 400V
<b>W7053_230V</b>	Hot water wax melter, 100 l, 230V



# WATER WAX MELTER, DUAL CHAMBER, WITH FRAME CLEANING FUNCTION

The double-chamber wax melter allows for efficient melting of wax and simultaneous cleaning of beekeeping frames.

Its well-thought-out design ensures effectiveness and helps improve the overall workflow of the apiary.

The compact structure saves space, while the flow-through system helps maintain clean area during the demanding process of wax melting.

**Technical data:**

- Power: 230V
- Width: 83 cm
- Length: 65 cm
- Height: 90 cm
- Temperature range: from 0°C to 120°C
- Pump power: 90 W
- Possibility of cleaning two frames at once



<b>W7054</b>	Water wax melter, dual chamber, with frame cleaning function
--------------	--

# MINI WAX MELTERS

**W4090**

- Acid-resistant stainless steel
- Power supply – 230V
- Heating power - 2kW
- Drain valve – ball valve 1/2"
- Temperature range 0 - 75°C
- Capacity of the tank (inside). 10 l
- Capacity of heating jacket 10 l
- Dimensions:

- length 400 mm,
- width 400 mm,
- height 380 mm
- Weight – 9,3 kg



<b>W4090</b>	Mini round wax melter, heating jacket
--------------	---------------------------------------

**W4099\_SET**

- acid stainless steel,
- steel thickness - outside 1mm, inside 1,5 mm
- power 230V,
- heating power 2kW,
- ball valve, stainless steel 1/2"

- adjustable temperature 0 - 75°C
- dimensions length 600 mm width 300 mm height 650 mm



<b>W4099_SET</b>	Mini wax melter, heating jacket, insulated cover
<b>W4099_S</b>	Hangers with stand for candle production - set of 5 pcs

## SET OF HANGERS FOR CANDLE PRODUCTION WITH WAX TANK

Set of hangers for candle production with wax container. Dipping tank designed for the production of dipped candles and features a high-quality stainless steel construction suitable for both hobbyist and professional use.

Technical parameters:

- Dimensions: 475 mm height × Ø 160 mm
- Wax container diameter: Ø 120 mm
- Wax capacity: approx. 4.5 liters
- Heating jacket capacity: approx. 4.5 liters
- Material: Stainless steel 1.4301
- Wall thickness: 1.2 mm (outer wall), 0.8 mm (inner wall)
- Bottom thickness: 1.2 mm
- Water drain: ½" ball valve for easy drainage of the water

The set includes three wick holders, making it a convenient and cost-effective solution.

**W4510**

Set of hangers (3 pcs.) for the production of dipped candles with a wax melting tank



## WAX STERILIZER 50 L WITH INSULATED JACKET

Technical parameters:

- Heater output 2kW
- Power supply 230V
- Capacity 50 l
- Weight approx. 40 kg
- Drain valve of heating liquid 1/2"
- Water drain valve 5/4"
- Wax drain valve 3/4"
- Outside diameter 500 mm
- Inner diameter 400 mm
- Total unit height 550 mm

**W7064P**

Wax sterilizer 50 l, insulated jacket



## WAX STERILIZER 200 L, WITH INSULATED JACKET

Technical parameters:

- Water drain valve 2"
- Wax drain valve 3/4"
- Oil or glycol drain valve 1/2"
- Venting
- Heater 6kw, 400V, temperature range 50-190°C
- Ø outside tank - 705 mm
- Ø int. Tank - 580 mm
- Overall dimensions of the tank: 960×860×1100 mm
- Capacity: 200 l
- Weight of tank without oil 75 kg
- Total volume of the tank (valves, heater) 840×740 mm
- Heating jacket capacity: 100 l,
- Medium: glycol

**W7058P**

Wax sterilizer 200 l, insulated jacket



# WAX SEPARATOR



- Separator made entirely of acid-resistant stainless steel
  - Drum diameter - Ø900 mm
  - Cover material: PMMA , thickness 6mm
  - Magnetic lock of the cover opening
  - Supply voltage: 230VAC
  - Drive power: 0.37kW
  - Heating power: 0.9kW
  - Drive located underneath the drum
  - Clutch for easy withdrawal of the work assembly
  - Maximum speed: 280 rpm
  - Adjustable basket speed
  - Temperature regulator in the range of 30÷55°C
  - Feed tray : on the side of the drum at the bottom
- Draining spigot:
- TC spigot DN 50 (6/4") + hose connection Ø 50 mm

Overall dimensions: L1320, W1000, H1360 mm  
Unit empty weight: 110 kg

ID	NAME
W4850_O	Wax separator with heated bottom



W4850\_O

# LARGE ROTARY WAX MELTER

## Technical data:

- The melter is insulated.
- The melting cycle time is approx. 20 minutes, which gives a total of 350-400 frames per day.
- Possibility of melting residues from presses.
- Two large cleaning nozzles are available
- The temperature generated is approx. 98°C at room temperature while the basket is in operation.
- Requires mains water supply
- Melting machine diameter: 1000 mm
- Heater 3 x 1500 W, 400 V power supply per heater
- 230 V controller



ID	NAME
W4807	Large rotary wax melter, Ø1000mm, insulated

## ROTARY WAX MELTER

The rotary melter is a device designed to recover wax from cut frames or entire frames located in a perforated basket. The drum, at the bottom of which there is a heater immersed in water, generating steam, heats the load to the appropriate temperature, enabling effective wax centrifugation. The melter is equipped with an external tank with a low water level protection that prevents the heater from burning. After obtaining the appropriate temperature, the melter melts down full load in about 20 minutes

### W4805

Technical data:

- Material: drum, perforated basket with an eyelet Ø3, cover - stainless steel - acid-resistant OH18N9
- Legs, rim, control housing - black powder coated steel
- Controller: SDD-2DP
- Power supply: 230V / 50Hz
- Heater power: 3000W
- Motor power: 250W
- Valve: flap 6/4 "
- Melter height: 1110mm
- Drum height/ diameter 480/505 mm
- Drain valve distance from the ground: 370mm



W4805

### W4805\_O

Technical data:

- Drum, perforated basket (hole Ø 3 mm), and lid: acid-resistant stainless steel OH18N9
- Legs, support ring, and control housing: powder-coated carbon steel
- Valve: flapper valve 6/4"
- Control system: SDD 2DP



W4805\_O

Specifications (custom version):

- Motor power: 350 W
- Heater power: 4,500 W (4.5 kW)
- Basket capacity: approx. 125 l
- Control: SDD 2DP
- Dimensions: 1200 × 1050 × 1050 mm
- Weight: approx. 75 kg
- Basket height / diameter: 450 × 600 mm
- Valve: flapper valve 6/4"

ID	NAME
W4805	Rotary wax melter

ID	NAME
W4805_O	Rotary wax melter, insulated
W4806_O	Rotary wax melter, insulated, Ø720 mm

## WAX MELTER - SOLAR, FOR 10-FRAMES

The solar wax melter is made of durable stainless steel and features effective insulation for improved heat retention. Smoked glass cover ensures safe and efficient operation under direct sunlight. For even better performance, the melter can be upgraded with a self-rotating solar module, which follows the sun to maximize wax melting efficiency.

**Specification:**

- Material: Stainless steel 1.4016, thickness 0.8 mm
- Insulation: Double jacket (insulated)
- Cover: 6 mm smoked glass, waterproof, 2 clamps + bolt

**Frame compatibility**

- Width: 320–470 mm
- Height: up to 300 mm
- Thickness: up to 37 mm
- Capacity: max. 10 frames
- Frame support: Adjustable beam – for different types of frames
- Leg/base: Galvanized sheet metal, swivel handle
- Angle adjustment: Yes – adjustment to the sun

ID	NAME
W3250	Wax melter - solar, for 10-frames
W3251	Self-rotating solar module for a solar wax melter



# SOLAR WAX MELTERS

WITH THE POSSIBILITY OF CONNECTING A STEAM GENERATOR

## W3249

- External dimensions:  
width: 55 cm, height: 20.5 cm, length: 92 cm
- Tub dimensions (for frames putting):  
width: 50 cm, length: 77 cm, height: 5 cm
- Cover from chamber plate



<b>W3249</b>	Stainless solar wax melter (large)
<b>W3200TD</b>	Stand for solar wax extractor, stainless steel 6(ID W3249)

## W3248A

- External dimensions:  
width: 36 cm, height: 21.5 cm, length: 62.5 cm
- Tub dimensions (for frames putting):  
width: 34 cm, length: 47 cm
- Cover from chamber plate



<b>W3248A</b>	Stainless solar wax melter (small)
<b>W3200TM</b>	Stand for solar wax extractor, stainless steel, small (ID W3248A)

## W3247

- External dimensions:  
width: 41 cm, height: 20,5 cm, length: 61 cm
- Tub dimensions (for frames putting):  
width: 34 cm, length: 39 cm
- Cover from chamber plate



<b>W3247</b>	Plastic solar wax melter (small)
<b>W3200P</b>	Stand for solar wax extractor, stainless steel, small (ID W3247)

## 9131

- External dimensions:  
width: 52.5 cm, length: 67 cm
- Tub dimensions (for putting frames):  
width: 48 cm, length: 53 cm, height: 5 cm
- Cover from chamber plate
- Wax melter made from MDF



<b>9131</b>	Wooden solar wax melter (zinc frame insert)
-------------	---

## W3246

- External dimensions:  
length - 600mm, width - 400mm, height - 330mm
- The set includes:
- body with cover made of EPP
- stainless steel tray for frames
- tray for wax Intended use:
- 1 frame: Dadant, Langstroth, DNM, Zander



<b>W3246</b>	Solar wax melter EPP
--------------	----------------------

# 4. POLLEN PROCESSING



# POLLEN DRYERS STAINLESS STEEL

## W3258C

External dimensions:

- width - 430 mm
- height - 1280 mm
- depth - 525 mm

Technical parameters:

- made of acid resistant stainless steel
- heater power 1000W
- temperature range - 30-55°C
- voltage - 230V
- fan power – 30W
- overheating protection

## W3258D

External dimensions:

- width - 430 mm
- height - 870 mm
- depth - 525 mm

Technical parameters:

- made of acid resistant stainless steel
- heater power 500W
- temperature range - 30-55°C
- voltage - 230V
- fan power – 30W
- overheating protection



W3258D	Pollen dryer, stainless steel - 5 drawers
W3258C	Pollen dryer, stainless steel - 10 drawers

# POLLEN DRYER AND DECRYSTALLIZATION CABINET 2 IN 1

## W32591

Power supply: 230V

Total power: 600W

Heater power: 500W

External dimensions: 800×640×680 mm  
(width×depth×height)

Drawers: 5 pcs.

## W32592

Power supply: 230V

Total power: 1100W

Heater power: 1000W

External dimensions: 800×640×880 mm  
(width×depth×height)

Drawers: 10 pcs.

## W32593

Power supply: 230V

Total power: 1200W

Heater power: 1000 W

Fan power: 30 W

External dimensions: 800×640×1080 mm  
(width×depth×height)

Drawers: 14 pcs.

Drawers width: 515 mm, drawers length: 450mm.

Temperature range: 30-55 °C



W32591	Pollen dryer and decrystallization cabinet 2-in-1, small, 5 shelves - Optima
W32592	Pollen dryer and decrystallization cabinet 2-in-1, small, 10 shelves - Optima
W32593	Pollen dryer and decrystallization cabinet 2-in-1, small, 14 shelves - Optima

# POLLEN DRYER 30 KG OF POLLEN



**W3262000** Pollen dryer, stainless steel (for 30 kg of pollen)

External dimensions:

- width - 1045 mm
- height - 870 mm
- depth - 545 mm
- width (of the opening through which the trolley passes) - 555 mm
- height (of the opening through which the trolley passes) - 815 mm
- wall of the chamber / thickness - 20 mm

Trolley dimensions:

- width - 550 mm
- height (with wheels) - 810 mm
- depth - 490 mm
- number of dryers - 10 pcs
- width of dryer - 460 mm
- length of dryer - 460 mm
- depth of dryer - 30 mm
- height of wheels - 115 mm



Pollen dryers parameters and specifications:

- pollen dryer entirely made of acid resistant stainless steel
- heaters power - 1x2kW
- temperature controller
- power supply - 230V
- ventilator - 100W

# POLLEN DRYER 60 KG OF POLLEN

**W326200** Pollen dryer, stainless steel (for 60 kg of pollen)

External dimensions:

- width - 1150 mm
- height - 950 mm
- depth - 650 mm
- width (of the opening through which the trolley passes) - 660 mm
- height (of the opening through which the trolley passes) - 925 mm
- wall of the chamber / thickness - 20 mm

Trolley dimensions:

- width - 655 mm
- height (with wheels) - 910 mm
- depth - 595 mm
- number of dryers - 12 pcs
- width of dryer - 565 mm
- length of dryer - 565 mm
- depth of dryer - 30 mm
- height of wheels - 115 mm

Pollen dryers parameters and specifications:

- pollen dryer entirely made of acid resistant stainless steel
- heaters power - 2x2kW
- possibility of using one or two heaters
- temperature controller
- power supply - 400V
- ventilator - 2x100W

# POLLEN DRYER 100 KG OF POLLEN

**W32620** Pollen dryer, stainless steel (for 100 kg of pollen)

External dimensions:

- width - 1150 mm
- height - 1390 mm
- depth - 655 mm
- width (of the opening through which the trolley passes) - 660 mm
- height (of the opening through which the trolley passes) - 1360 mm
- wall of the chamber / thickness - 20 mm

Trolley dimensions:

- width - 655 mm
- height (with wheels) - 1350 mm
- depth - 595 mm
- number of dryers - 20 pcs
- width of dryer - 565 mm
- length of dryer - 565 mm
- depth of dryer - 30 mm
- height of wheels - 115 mm

Pollen dryers parameters and specifications:

- pollen dryer entirely made of acid resistant stainless steel
- heaters power - 2x2kW
- possibility of using one or two heaters
- temperature controller
- power supply - 400V
- ventilator - 2x100W

## POLLEN CLEANER - MINIMA LINE



**Specifications:**

- Construction made of stainless steel (grade 1.4301.)
- Power supply: 230V
- Power: 9,2 W
- Net weight: 9 kg
- Hopper capacity: 6 litres = 3.5 kg of pollen
- Performance: approx. 50 kg/h

**Dimensions:**

- Width 400 mm
- Length 750 mm
- Height 930 mm

The set includes a pollen debris bag measuring 50x80.



## POLLEN CLEANER - OPTIMA LINE



**Specifications:**

- construction made of powder coated black sheet
- refills made of stainless steel
- power supply – 230V
- engine power – 250W with adjustable speed
- fun power 67W with adjustable speed
- weight – 22 kg

**Dimensions:**

- Width 400 mm
- Length 900 mm
- Height 650 mm



W3219

Pollen cleaner 230V - MINIMA

W3215

Pollen cleaner, powder coated steel, 230V OPTIMA

## POLLEN CLEANER - CLASSIC LINE



**Technical data:**

- Motor: 250W (infinitely variable speed control)
- Fan: 80W/230V (infinitely variable speed control)
- Power supply: 230V
- Elements in contact with pollen made of acid resistant stainless steel (grade 1.4301)
- Pollen hopper equipped with a vibrating motor

**Dimensions:**

- Width 1104 mm
- Length 406 mm
- Height 1095 mm

**Dimensions of upper pollen hopper:**

- Width 303 mm
- Length 300 mm
- Depth 183 mm



W3213

Pollen cleaner 230V - CLASSIC

# DRY POLLEN CLEANER – MAXI

Pollen dry cleaner – MAXI is a modern and innovative solution, equipped with 3 fans. It has a smooth adjustment of the force of the blown air. The construction material of the device is powder coated steel. Elements in direct contact with pollen are made of stainless steel. The fans are supplemented by movable, reinforced screens made of stainless steel. The upper meshes are 4 mm in diameter and the lower ones are 0.5 mm in diameter.

**Technical specifications:**

- the construction - powder coated steel
- chute and cleaning inserts made of steel stainless
- power supply - 230V
- power consumed - 285W.
- drive motor with smooth rotation regulation
- fans have smooth rotation regulation
- dimensions:
- length 1,380 mm (folded), 1,710 mm (unfolded)
- width 1350 mm, height 1870 mm
- net weight - 190 kg

**W3216** | Pollen dry cleaner - MAXI



# VIBRATING POLLEN CLEANER 45 L

**Description:**

- fill capacity 45 l
  - power supply 230V
  - power output 50W
  - stepless vibration motor adjustment
  - knitted stainless steel mesh, 4x4mm mesh
  - width 510mm
  - depth 710mm
  - height 1200mm
  - weight 66kg
- Dirt separator  
230V/1650W



The plastic pail is not included

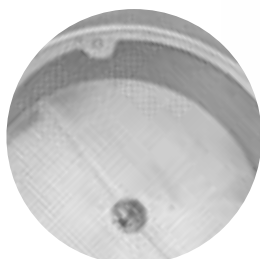

**W3217** | Vibrating pollen cleaner 230V, 45 l

# PROPOLIS EXTRACTION MACHINE

**Technical data:**

- power supply: 230V
- motor power: 80W
- potentiometer control
- weight - 50 kg



**W380** | Propolis extraction machine

# 5. BEEHIVES & BEEHIVE ELEMENTS



## ROOFS

### Modified shape:

allows the roofs to be safely stacked on top of each other for easier storage and organization of work in the apiary.

### Ventilation hole:

improved air circulation inside the hive for optimal thermoregulation and better conditions for the bees.

### Increased durability:

tougher construction compared to previous models.

### Design with slopes:

facilitates rainwater drainage, protecting the hive from moisture.

### Flattening in the middle:

ideal place to store the smoker with cooler while working in the apiary.

### Higher density polystyrene:

provides better resistance to external conditions and adds weight and stability, which contributes to the durability of the roof.



Beehive roofs come in both low and high profiles, depending on the hive design and climate needs.

They play an important role in insulation and ventilation, helping to maintain a stable environment inside the hive. Lyson's wide range of hive roofs allows beekeepers to choose the option that best suits their individual needs and preferences.

## CROWN BOARDS

Crown board is protecting upper part of bee nest. It has a form of flat plate with thick edges.

On the crown board surface there are 5 to 7 round vent-holes.

Crown board plastic ventilating plug, round shaped plugs can be placed inside vent-holes or vent-holes can be closed with Styrofoam plugs. Crown board is the most important part of a beehive which is responsible for ventilation of a bee nest.

Ventilation intensity can be controlled by opening or closing vent-holes in the crown board's surface.

Bees can be fed from "twist-off" jars with syrup or fed through round holes in crown board. In order to do that, closed jars with perforated lids should be placed 'bottom up' on "Spider web" plug in crown board's holes.



Crown board in the Styrofoam hives is the most important part that ventilates bee nest. "Spider web" plug mesh except its ventilating function works as excellent propolis trap. The purity of propolis which is harvested this way is 1st class and does not require further purification.



## HIVE BODIES

### • Hive body – Honey super

Honey super body is used for storing honey. Such body (depending on the frame size in brood box) is usually half lower and has half lower capacity than brood box.

### • Honey super has following application:

- it increases hive capacity during transport,
- it is possible to place insulating material or feeder inside the body,
- it increases ventilation if it is placed between bottom board and brood box where bee colony is wintering.

Apart from complete, ready to use styrofoam bodies, some of the producers offer self-assembly bodies in which all parts that can be screwed together.

Before assembling, hive has relatively small size, what is especially important during transport from a producer to the customer.

Hive body which is screwed with bolts has lower flexibility and has lower stress sensitivity.

Brood boxes, honey supers (bodies) and bottom boards are produced with and without notches.

### • Brood boxes

There is located nest of bee colony. In most of the beehives they serve as honey super (honey 'storehouse'). In the brood box there are 10 brood frames. Each styrofoam body is equipped with vent-hole.

If needed vent-hole can be closed with trapeze-shaped plastic ventilation cap with perforation or tight styrofoam cap.

In the outside part of the hive bodies there are grooves which enable easy grasping and transportation.



Single parts of beehive have reinforced notches in the corners which facilitate chisel insertion.

## BOTTOM BOARDS

- Low and high bottom board

(Bottom board) is a flat bottom of the hive. Its edges are constructed in the way that enables to keep 4 cm distance between bottom and bottom slats of frames which are placed in lower body. Bottom board is equipped with 4 round vent holes closed with crown board plastic ventilating plug, round. Vent holes can be closed with round styrofoam covers. Along the front edge of the hive bottom board there is an entrance hole which size can be regulated with a plastic insert.

- High bottom board

- Low bottom board



## HIGH VARROA BOTTOM BOARDS

High varroa bottom board is in shape of a flat box with sidewalls which are several centimeters high. It is equipped with a mesh excluder. On the bottom there is plastic tray (drawer).

In the front wall there is an entrance hole which size can be regulated with a plastic insert.

In the bottom of a styrofoam hive bottom board there are flat feet made of strong plastic, that are protecting the bottom from damages during transport. Varroa bottom enables varroa diagnosis.



## POLYSTYRENE POLLEN TRAP

An optional hive element which allows to harvest bee pollen by removing it from the bees' pollen baskets and collecting them on the bottom board's trap. The trap should be mounted directly on the bottom board.



## DISTANCE RINGS

(Distance rings) increase the space between the bodies. There is a beaverboard with installed bee escape embed in the ring. Distance ring can be used during colony feeding with cake to increase distance between top bars of frames and crown board.

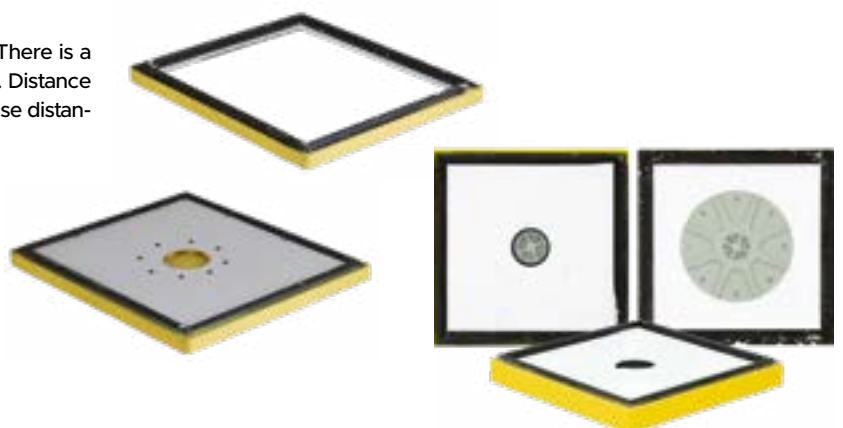

# BEEHIVE WITH PRINT, DADANT OPTIMA, PAINTED



**PRINT-LEAVES**



**PRINT-BEE**



**PRINT-CHILDREN**



**PRINT-DAISIES**



**PRINT-FLOWERS**

This hive is a great way to stand out from other beekeepers and give your apiary a unique character. By offering original graphics on your hives, you create not only a functional habitat for your bees, but also an artistic element in the landscape.

Printed beehives are an innovative way to combine functionality with aesthetics and an opportunity to express your individuality in your apiary. Advanced printing technology guarantees intensive colours and durability.

Thanks to the protective layer, prints on every beehive do not fade and are resistant to weather conditions. Methods used during whole production process allow you to enjoy your unique apiary for a long time!

Choose from over 20 designs – ask our sales representative for details.

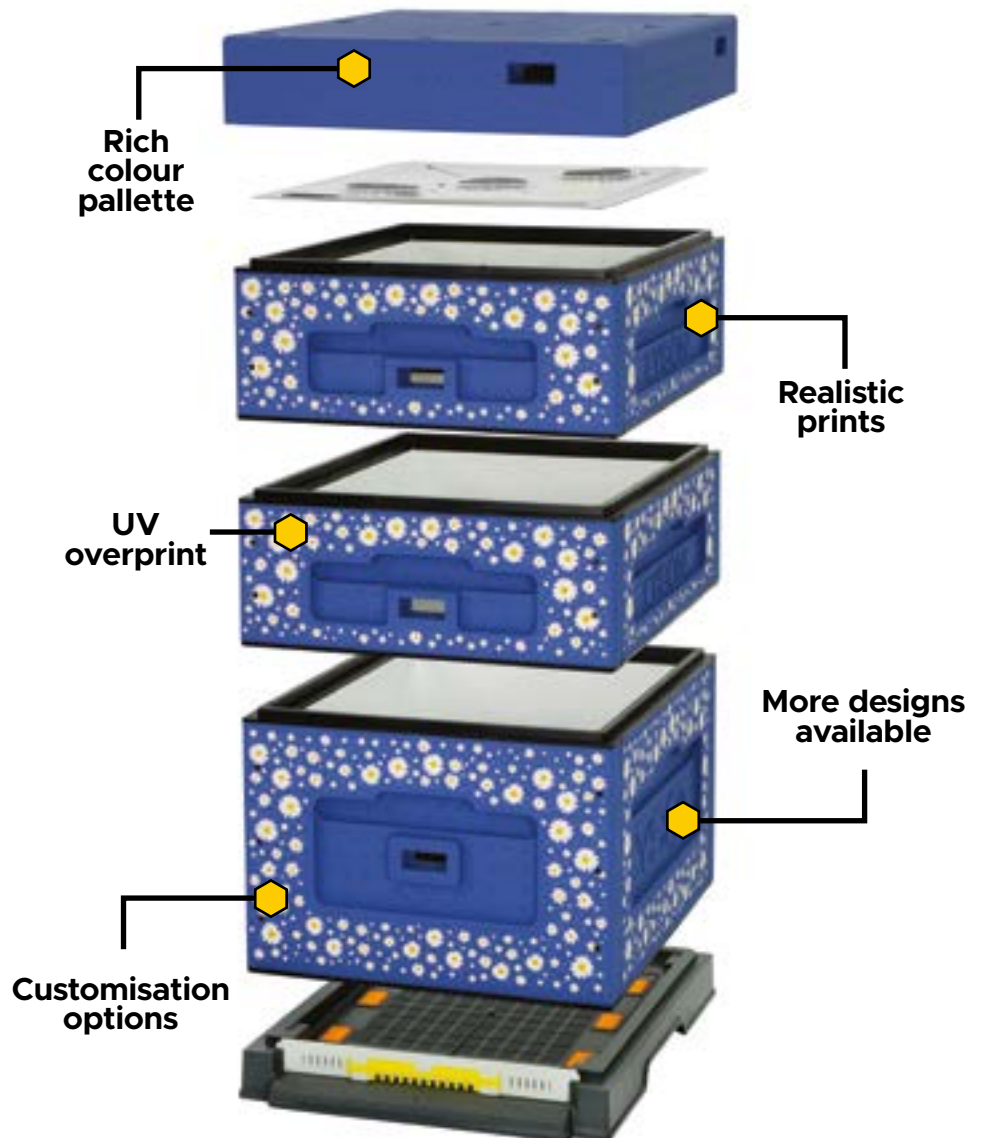

# BEEHIVE WITH PRINT, DADANT OPTIMA, PAINTED

## OPTIMA line

Dadant hive set:

- high roof
- 2× body ½ - available in two sizes:  
**size A\***: 380×450×142 mm  
 (inner dimensions) - 2 pcs  
**size B\***: 380×450×160 mm-  
 (inner dimensions) - 2 pcs
- 1× body (inner dimensions):  
 380×450×298 mm
- plastic bottom low hygienic board OPTIMA

\*When placing an order, please indicate, which size of body ½ (size A or size B) is required.

Frame dimensions:

- Dadant: 470×300 mm
  - Dadant ½ (SIZE A):  
 470×145 mm
- or
- Dadant ½ (SIZE B):  
 470×159 mm



### Advantages of printed beehives:

- unique aesthetics
- protection against abrasion thanks to UV coating
- longevity of colours

These hives are a functional tool in the apiary and an expression of care for aesthetics and individuality in beekeeping.

### Also on offer:

- choice of 5 colors in fixed configuration
- more designs available
- personalized imprint - pricing and lead time after individual consultation



ID	NAME
<a href="#">LU1008H_O_POM_N_NAD1</a>	Beehive Dadant OPTIMA, painted (orange), print - bee, unassembled
<a href="#">LU1008H_O_RC_NAD2</a>	Beehive Dadant OPTIMA, painted (dark pink), print - flowers, unassembled
<a href="#">LU1008H_O_ZC_N_NAD3</a>	Beehive Dadant OPTIMA, painted (dark green), print - leaves, unassembled
<a href="#">LU1008H_O_ZO_NAD4</a>	Beehive Dadant OPTIMA, painted (yellow), print - children, unassembled
<a href="#">LU1008H_O_NC_NAD5</a>	Beehive Dadant OPTIMA, painted (dark blue), print - daisies, unassembled
<a href="#">LU1008H_B_O_POM_N_NAD1</a>	Beehive Dadant OPTIMA, painted (orange), print - bee, version B, unassembled
<a href="#">LU1008H_B_O_RC_NAD2</a>	Beehive Dadant OPTIMA, painted (dark pink), print - flowers, version B, unassembled
<a href="#">LU1008H_B_O_ZC_N_NAD3</a>	Beehive Dadant OPTIMA, painted (dark green), print - leaves, version B, unassembled
<a href="#">LU1008H_B_O_ZO_NAD4</a>	Beehive Dadant OPTIMA, painted (yellow), print - children, version B, unassembled
<a href="#">LU1008H_B_O_NC_NAD5</a>	Beehive Dadant OPTIMA, painted (dark blue), print - daisies, version B, unassembled

# DADANT BEEHIVES OPTIMA



Dadant hive set:

- high roof
- 2× body ½ - available in two sizes:
  - size A\***: 380×450×142 mm (inner dimensions) - 2 pcs
  - size B\***: 380×450×160 mm (inner dimensions) - 2 pcs
- 1× body (inner dimensions): 380×450×298 mm
- plastic bottom low hygienic board OPTIMA

\*When placing an order, please indicate, which size of body ½ (size A or size B) is required.

Frame dimensions:

- Dadant: 470×300 mm
- Dadant ½ (SIZE A): 470×145 mm
- or Dadant ½ (SIZE B): 470×159 mm



not painted		NAME
W10170_O		Dadant body
W10180_O		Dadant body ½ SIZE A
W10750_O		Dadant body ½ SIZE B
W10150_O		High roof with ventilation
W10150W_O		High roof Dadant, height 135 mm
painted		
ORANGE	GREEN	
W1017_O_POM	W1017_O_ZC	Dadant body
W1018_O_POM	W1018_O_ZC	Dadant body ½ SIZE A
W1075_O_POM	W1075_O_ZC	Dadant body ½ SIZE B
GREY		
W1015_O_SZ		High roof with ventilation
W1015W_O_SZ		High roof Dadant, height 135 mm
plastic		
8059		Plastic bottom board OPTIMA



Ventilating plugs included as standard to every beehive with ventilation

not painted		NAME
LU10080HN_O		Dadant beehive OPTIMA with plastic feeder 7,5 l and low plastic hygienic bottom SIZE A
LU10080HN_B_O		Dadant beehive OPTIMA with plastic feeder 7,5 l and low plastic hygienic bottom SIZE B
LU10080H_O		Dadant beehive OPTIMA, with plastic transparent crown board, with low plastic hygienic bottom SIZE A
LU10080H_O_B		Dadant beehive OPTIMA, with plastic transparent crown board, with low plastic hygienic bottom SIZE B
painted		
ORANGE	GREEN	
LU1008HN_O_POM	LU1008HN_O_ZC	Dadant beehive OPTIMA with plastic feeder 7,5 l and low plastic hygienic bottom SIZE A
LU1008HN_B_O_POM	LU1008HN_B_O_ZC	Dadant beehive OPTIMA with plastic feeder 7,5 l and low plastic hygienic bottom SIZE B
LU1008H_O_POM	LU1008H_O_ZC	Dadant beehive OPTIMA, with plastic transparent crown board, with low plastic hygienic bottom SIZE A
LU1008H_B_O_POM	LU1008H_B_O_ZC	Dadant beehive OPTIMA, with plastic transparent crown board, with low plastic hygienic bottom SIZE B

# EDUCATIONAL DADANT BEEHIVE + 12 FRAMES WITH TEACHING BOARDS

The demonstration hive consists of an original polystyrene beehive of the Dadant type, equipped with twelve frames with teaching boards. Each frame has two color boards on both sides, with dimensions of 435x300 mm. Graphics on educational boards have been placed in wooden frames, which allows children to even better illustrate the internal structure of the beehive. In addition, the body, roof and bottom are made of high-quality polystyrene, which makes the demonstration hive lightweight and durable, making it easy to transport during a beekeeping presentation.



## Specification of the product:

- Educational, polystyrene beehive, painted, Dadant  
+ set of 12pcs frames with teaching boards on both sides.

## Educational hive composition:

- 1 x bottom Dadant W1122\_E
- 1 x body Dadant W1017\_E
- 1 x roof Dadant W1015\_E
- 

**Minimum order quantity: 5 sets.**



ID	NAME
EDUK_EN	Set of 12 frames with teaching boards - English version
EDUK2_EN	Educational Dadant beehive + 12 frames with teaching boards - English version
EDUK_CZ	Set of 12 frames with teaching boards - Czech version
EDUK2_CZ	Educational Dadant beehive + 12 frames with teaching boards - Czech version
EDUK_FR	Set of 12 frames with teaching boards - French version
EDUK2_FR	Educational Dadant beehive + 12 frames with teaching boards - French version
EDUK_ES	Set of 12 frames with teaching boards - Spanish version
EDUK2_ES	Educational Dadant beehive + 12 frames with teaching boards - Spanish version
EDUK_IT	Set of 12 frames with teaching boards - Italian version
EDUK2_IT	Educational Dadant beehive + 12 frames with teaching boards - Italian version
EDUK_RO	Set of 12 frames with teaching boards - Romanian version
EDUK2_RO	Educational Dadant beehive + 12 frames with teaching boards - Romanian version

# DADANT BEEHIVES WITH PLASTIC BOTTOM

**Dadant hive set:**

- high roof
- 2x body ½ - available in two sizes:  
**size A\*:** 377x448x142 mm (inner dimensions) - 2 pcs  
**size B\*:** 377x448x160 mm (inner dimensions) - 2 pcs
- crown board
- 1x body (inner dimensions): 377x448x295 mm
- plastic bottom board

\*When placing an order, please indicate, which size of body ½ (size A or size B) is required.

**Dadant ½ hive set:**

- high roof
- 4x body ½ - available in two sizes:  
**size A\*:** 377x448x142 mm (inner dimensions) - 4 pcs  
**size B\*:** 377x448x160 mm (inner dimensions) - 4 pcs
- crown board
- plastic bottom board

\*When placing an order, please indicate, which size of body ½ (size A or size B) is required.

- Frame dimensions:**
- Dadant: 470x300 mm
  - Dadant ½ (SIZE A): 470x145 mm
- or
- Dadant ½ (SIZE B): 470x159 mm



Ventilating plugs included as standard to every beehive with ventilation

Painted	Not Painted	
<b>SIZE A</b>		
<b>LU1008H</b>	<b>LU10080H</b>	Dadant beehive with high plastic hygienic bottom
<b>LU1006B</b>	<b>LU100600B</b>	Dadant ½ beehive with high hygienic plastic bottom
<b>SIZE B</b>		
<b>LU1008H_B</b>	<b>LU10080H_B</b>	Dadant beehive with high plastic hygienic bottom
<b>LU1006B_B</b>	<b>LU100600B_B</b>	Dadant ½ beehive with high hygienic plastic bottom



Varroa control



High endurance



Lowest price on the market



Easy to clean and disinfect

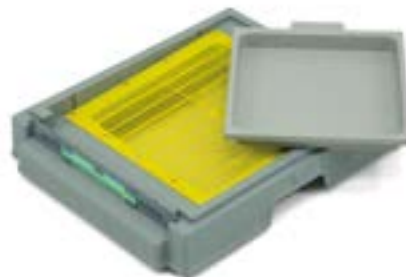

<b>8051</b>	Hygienic plastic bottom board - Dadant CLASSIC
<b>8059</b>	Hygienic plastic bottom Dadant OPTIMA

## ACCESSORIES TO PLASTIC BOTTOM BOARD

ACCESSORIES TO PLASTIC BOTTOM BOARD	
<b>8051S</b>	Grid for plastic varroa bottom Dadant
<b>8050KR</b>	Metal grid for plastic varroa bottom
<b>3179</b>	Plastic entrance reducer
<b>8051T</b>	Plastic tray to the hygienic bottom: Dadant

## CROWN BOARD TRANSPARENT DADANT

10-frames, 3 holes, with thermometer and 3 ventilating plugs



**W102109**

Crown board transparent Dadant 10-frames, 3 holes, with thermometer and 3 ventilating plugs

# DADANT BEEHIVES WITH POLYSTYRENE BOTTOM

Dadant hive set:

- high roof
- 2× body ½ - available in two sizes:
  - size A\***: 377×448×142 mm (inner dimensions) - 2 pcs
  - size B\***: 377×448×160 mm (inner dimensions) - 2 pcs
- crown board
- 1× body (inner dimensions): 377×448×295 mm
- low, high or high varroa bottom board

\*When placing an order, please indicate, which size of body ½ (size A or size B) is required.

Frame dimensions:

- Dadant: 470×300 mm
- Dadant ½ (SIZE A): 470×145 mm
- or
- Dadant ½ (SIZE B): 470×159 mm



Ventilating plugs included as standard to every beehive with ventilation



DADANT BEEHIVE SIZE A		
painting	not painting	
W1007	W10070	with low bottom board
W1008	W100800	with high bottom board
W1008H	W10080H	with high varroa bottom board
W1008D	W10080D	with bottom board pollen trap

DADANT BEEHIVE SIZE B		
painting	not painting	
W1007_B	W10070_B	with low bottom board
W1008_B	W100800_B	with high bottom board
W1008H_B	W10080H_B	with high varroa bottom board
W1008D_B	W10080D_B	with bottom board pollen trap

# DADANT ½ BEEHIVES WITH POLYSTYRENE BOTTOM

Dadant ½ hive set:

- high roof
- 4× body ½ - available in two sizes:
  - size A\***: 377×448×142 mm (inner dimensions) - 4 pcs
  - size B\***: 377×448×60 mm (inner dimensions) - 4 pcs
- crown board
- low, high or high varroa bottom board

\*When placing an order, please indicate, which size of body ½ (size A or size B) is required.

Frame dimensions:

- Dadant ½ (SIZE A): 470×145 mm
- or
- Dadant ½ (SIZE B): 470×159 mm



Ventilating plugs included as standard to every beehive with ventilation



DADANT ½ BEEHIVE SIZE A		
painting	not painting	
W1005	W10050	with low bottom board
W1006	W100600	with high bottom board
W1006B	W100600B	with high varroa bottom board
W1006D	W100600D	with bottom board pollen trap

DADANT ½ BEEHIVE SIZE B		
painting	not painting	
W1005_B	W10050_B	with low bottom board
W1006_B	W100600_B	with high bottom board
W1006B_B	W100600B_B	with high varroa bottom board
W1006D_B	W100600D_B	with bottom board pollen trap

# DADANT BEEHIVES PINK

Dadant hive set:

- high roof
- 2× body ½ - available in two sizes:
  - size A\***: 377×448×142 mm (inner dimensions) - 2 pcs
  - size B\***: 377×448×160 mm (inner dimensions) - 2 pcs
- crown board
- 1× body (inner dimensions): 377×448×295 mm
- plastic bottom board

\*When placing an order, please indicate, which size of body ½ (size A or size B) is required.

Frame dimensions:

- Dadant: 470×300 mm
- Dadant ½ (SIZE A): 470×145 mm
- or
- Dadant ½ (SIZE B): 470×159 mm



Ventilating plugs included as standard to every beehive with ventilation



NAME	PINK
Dadant hive with a high hygienic plastic bottom board - painted	<b>LU1008H_R</b>
Dadant body	<b>W1017_R</b>
Dadant body ½ <b>SIZE A</b> (frame 145 mm)	<b>W1018_R</b>
Dadant body ½ <b>SIZE B</b> (frame 159 mm)	<b>W1075_R</b>

NAME	GREY
High roof with ventilation	<b>W1015C_SZ</b>
Crown board	<b>W1021_SZ</b>
Distance ring with a bee escape (monolith)	<b>W1026_M-SZ</b>

# DADANT BEEHIVES GREEN

Dadant hive set:

- high roof
- 2× body ½ - available in two sizes:
  - size A\***: 377×448×142 mm (inner dimensions) - 2 pcs
  - size B\***: 377×448×160 mm (inner dimensions) - 2 pcs
- crown board
- 1× body (inner dimensions): 377×448×295 mm
- plastic bottom board

\*When placing an order, please indicate, which size of body ½ (size A or size B) is required.

Frame dimensions:

- Dadant: 470×300 mm
- Dadant ½ (SIZE A): 470×145 mm
- or
- Dadant ½ (SIZE B): 470×159 mm



Ventilating plugs included as standard to every beehive with ventilation



NAME	GREEN
Dadant hive with a high hygienic plastic bottom board - painted	<b>LU1008H_Z</b>
Dadant body	<b>W1017_Z</b>
Dadant body ½ <b>SIZE A</b> (frame 145 mm)	<b>W1018_Z</b>
Dadant body ½ <b>SIZE B</b> (frame 159 mm)	<b>W1075_Z</b>

NAME	GREY
High roof with ventilation	<b>W1015C_SZ</b>
Crown board	<b>W1021_SZ</b>
Distance ring with a bee escape (monolith)	<b>W1026_M-SZ</b>

# COMPONENTS OF DADANT AND DADANT ½ BEEHIVES



BASIC COMPONENTS FOR DADANT		
Painted	Not Painted	
W1016	W10160	Roof, low
W1015C	W10150C	Roof, high
W1021	W10210	Crown board
W1018	W10180	Body ½ <b>SIZE A</b> (frame 145 mm)
W1075	W10750	Body ½ <b>SIZE B</b> (frame 159 mm)
W1017	W10170	Body
W1122	W11220	Low bottom board
W1022	W10220	High bottom board
W102200	W1022000	High varroa bottom board
W1025	W10250	Bottom board pollen trap



ADDITIONAL COMPONENTS FOR DADANT		
Painted	Not Painted	
W1123A	W11230	Body feeder
W1024	W10240	Pollen trap screen fits W1022/ W10220
W102400	W1024000	Pollen trap for Varroa bottom board fits W102200/ W1022000
W1026	W10260	Distance ring
W602220	W602220N	Distance ring with bee escape, 8 outlet
-	W1030	Partition ½
-	W1029	Partition
W1147	-	Varroa grating (to varroa controlling)
W1123B	W11230B	Dadant, Dadant ½ body feeder, 10 l

ID	NAME
W1024000_VER2	Pollen trap for Dadant beehives for hygienic bottom board, VERSION 2, not painted
W102400_VER2_ZO	Pollen trap for Dadant beehives for hygienic bottom board, VERSION 2, painted (YELLOW)
W102400_VER2_N	Pollen trap for Dadant beehives for hygienic bottom board, VERSION 2, painted (BLUE)
W102400_VER2_Z	Pollen trap for Dadant beehives for hygienic bottom board, VERSION 2, painted (GREEN)
W102400_VER2_SE	Pollen trap for Dadant beehives for hygienic bottom board, VERSION 2, painted (CELADON)
W102400_VER2_SZ	Pollen trap for Dadant beehives for hygienic bottom board, VERSION 2, painted (GREY)
W102400_VER2_P	Pollen trap for Dadant beehives for hygienic bottom board, VERSION 2, painted (ORANGE)
W102400_VER2_R	Pollen trap for Dadant beehives for hygienic bottom board, VERSION 2, painted (PINK)

# DADANT BEEHIVES PREMIUM

Our new Dadant PREMIUM beehive is a top-of-the-range product that not only meets expectations in terms of quality, but also facilitates the daily work. Roof and bottom board have been designed in a way that makes it easy and comfortable to set beehives close to each other (e.g. during transporting between apiaries). Strengthened constructions of these elements, as the most important features, can't be missed. Thanks to an exceptional durability and resistance to weather conditions trying this beehive is definitely one of the best decisions you can make.

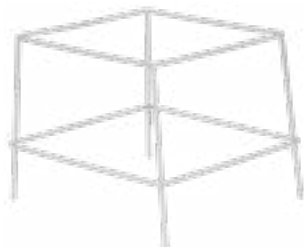

W4031N\_P



Ventilating plugs included as standard to every beehive with ventilation

When ordering more than 50pcs. - We paint the roof and the bottom board in 7 colours at the same price as the painted basic colour



W1015T



W102200T

Green, yellow, blue, pink, grey, celadon green, orange



W1008HTP



W1015T

3086

W1018

W1021

W1018

W1017

W102200T

COMPONENTS FOR DADANT - PREMIUM		
Painted	Not Painted	
W1015T	W10150T	Roof, high Dadant, Langstroth - PREMIUM
W1021	W10210	Crown board
W1018	W10180	Body 1/2 <b>SIZE A</b> (frame 145 mm)
W1075	W10750	Body 1/2 <b>SIZE B</b> (frame 159 mm)
W1017	W10170	Body
W102200T	W1022000T	High varroa bottom board Dadant, LN - PREMIUM
Plastic		
3086		Upper feeder 7,5l Dadant

DADANT BEEHIVE - PREMIUM		
Painted	Not Painted	
W1008HTP	W10080HTP	Roof, upper feeder, 2 x body 1/2, 1 x body, crown board, high bottom <b>SIZE A</b>
W1008HTP_B	W10080HTP_B	Roof, upper feeder, 2 x body 1/2, 1 x body, crown board, high bottom <b>SIZE B</b>
W4031N_P		Stainless steel stand for Premium bottom boards

# MULTI-FRAME

## NEW LINE OF BEEHIVES!

Innovation in the self-assembly  
beehive category!  
Slats integrated with the hive body walls.

 Hive for easy  
self-assembly  
thanks to  
„dovetail” system.



- ◆ **VERSATILITY**
- ◆ **LONGEVITY**
- ◆ **CONVENIENCE**
- ◆ **VARIOUS CONFIGURATIONS**



**SCAN  
THE CODE  
and watch  
the video!**

**NEW**

# MULTI-FRAME 10 FRAMES DADANT BEEHIVE, VERSION A

- roof 375×450×296 mm
- top feeder
- body ½ - 375×450×142 mm (inner dimensions) - without notches, 2 pcs
- body (inner dimensions):
- high varroa bottom board
- Frame dimensions:
- Dadant: 470×300 mm
- Dadant ½ (SIZE A): 470×145 mm



CHOOSE YOUR COLOR



COMPONENTS FOR MULTI-FRAME 10 FRAMES DADANT BEEHIVE, VERSION A			
not painted	orange	green	
WMT1	WMT1_P	WMT1_Z	Multi-frame low roof, 10 frames
WMT2	WMT2_P	WMT2_Z	Multi-frame high roof, 10 frames
WMT3	WMT3_P	WMT3_Z	Multi-frame body feeder, 10 frames
M3386	-	-	Plastic top feeder 7,5l Multi-frame
WMT7	WMT7_P	WMT7_Z	Multi-frame, Dadant, version A, ½ hive body (frame 145mm)
WMT9	WMT9_P	WMT9_Z	Multi-frame, Dadant, body
M8060	-	-	Multi-frame plastic low bottom board, hygenic

MULTI-FRAME 10 FRAMES DADANT BEEHIVE, VERSION A			
not painted	orange	green	
MT104	MT104_P	MT104_Z	low roof, ½ body (frame 145 mm) x2, brood body x 1, top feeder 2 x 4,5l, low bottom board
MT105	MT105_P	MT105_Z	high roof, ½ body (frame 145 mm) x2, brood body x 1, plastic top feeder 7,5l, low bottom board

# MULTI-FRAME 10 FRAMES DADANT BEEHIVE, VERSION B

- roof 375×450×296 mm
- top feeder
- body ½ - 375×450×160 mm (inner dimensions) - without notches, 2 pcs
- body (inner dimensions):
- high varroa bottom board
- Frame dimensions:
- Dadant: 470×300 mm
- Dadant ½ (SIZE B): 470×159 mm



CHOOSE YOUR COLOR



COMPONENTS FOR MULTI-FRAME 10 FRAMES DADANT BEEHIVE, VERSION B			
not painted	orange	green	
WMT1	WMT1_P	WMT1_Z	Multi-frame low roof, 10 frames
WMT2	WMT2_P	WMT2_Z	Multi-frame high roof, 10 frames
WMT3	WMT3_P	WMT3_Z	Multi-frame body feeder, 10 frames
M3386	-	-	Plastic top feeder 7,5l Multi-frame
WMT8	WMT8_P	WMT8_Z	Multi-frame, Dadant, version A, ½ hive body (frame 159 mm)
M8060	-	-	Multi-frame plastic low bottom board, hygenic

MULTI-FRAME 10 FRAMES DADANT BEEHIVE, VERSION B			
not painted	orange	green	
MT106	MT106_P	MT106_Z	low roof, ½ body (frame 159 mm) x2, brood body x 1, top feeder 2 x 4,5l, low bottom board
MT107	MT107_P	MT107_Z	high roof, ½ body (frame 159 mm) x2, brood body x 1, plastic top feeder 7,5l, low bottom board

# MULTI-FRAME 10 FRAMES DADANT US BEEHIVE

- roof
  - top feeder
  - body ½ - 375×465×157 mm (inner dimensions) - without notches, 2 pcs
  - body (inner dimensions): 375×465×281 mm
  - high varroa bottom board
- Frame dimensions:
- Dadant US: 482×285 mm
  - Dadant US ½: 482×159 mm



CHOOSE YOUR COLOR



COMPONENTS FOR MULTI-FRAME 10 FRAMES DADANT US BEEHIVE			
not painted	orange	green	
WMT1	WMT1_P	WMT1_Z	Multi-frame low roof, 10 frames
WMT2	WMT2_P	WMT2_Z	Multi-frame high roof, 10 frames
WMT3	WMT3_P	WMT3_Z	Multi-frame body feeder, 10 frames
M3386	-	-	Plastic top feeder 7,5l Multi-frame
WMT5	WMT5_P	WMT5_Z	Multi-frame American Langstroth, Dadant US, body ½
WMT10	WMT10_P	WMT10_Z	Multi-frame Dadant US, hive body
M8060	-	-	Multi-frame plastic low bottom board, hygenic

MULTI-FRAME 10 FRAMES DADANT US BEEHIVE			
not painted	orange	green	
MT108	MT108_P	MT108_Z	low roof, ½ body x2, brood body x 1, top feeder 2 x 4,5l, low bottom board
MT109	MT109_P	MT109_Z	high roof, ½ body x2, brood body x 1, plastic top feeder 7,5l, low bottom board

# MULTI-FRAME 10 FRAMES AMERICAN LANGSTROTH BEEHIVE

- roof
  - top feeder
  - body (inner dimensions): 375×465×242 mm - without notches, 2 pcs
  - high varroa bottom board
- Frame dimensions:
- American Langstroth: 482×232 mm
  - American Langstroth ½: 482×159 mm



CHOOSE YOUR COLOR



COMPONENTS FOR MULTI-FRAME 10 FRAMES AMERICAN LANGSTROTH BEEHIVE			
not painted	orange	green	
WMT1	WMT1_P	WMT1_Z	Multi-frame low roof, 10 frames
WMT2	WMT2_P	WMT2_Z	Multi-frame high roof, 10 frames
WMT3	WMT3_P	WMT3_Z	Multi-frame body feeder, 10 frames
M3386	-	-	Plastic top feeder 7,5l Multi-frame
WMT4	WMT4_P	WMT4_Z	Multi-frame, American Langstroth body
M8060	-	-	Multi-frame plastic low bottom board, hygenic

MULTI-FRAME 10 FRAMES AMERICAN LANGSTROTH BEEHIVE			
not painted	orange	green	
MT100	MT100_P	MT100_Z	low roof, body x 2, top feeder 2 x 4,5l, low bottom board
MT101	MT101_P	MT101_Z	high roof, brood body x 2, plastic top feeder 7,5l, low bottom board

# MULTI-FRAME 10 FRAMES AMERICAN LANGSTROTH BEEHIVE



- roof 375×465×242 mm
  - top feeder
  - body ½ - 375×465×170 mm (inner dimensions) - without notches, 2 pcs
  - body (inner dimensions): 375×465×242 mm
  - high varroa bottom board
- Frame dimensions:
- American Langstroth: 482×232 mm
  - American Langstroth ½: 482×159 mm



COMPONENTS FOR MULTI-FRAME 10 FRAMES AMERICAN LANGSTROTH BEEHIVE			
not painted	orange	green	
WMT1	WMT1_P	WMT1_Z	Multi-frame low roof, 10 frames
WMT2	WMT2_P	WMT2_Z	Multi-frame high roof, 10 frames
WMT3	WMT3_P	WMT3_Z	Multi-frame body feeder, 10 frames
M3386	-	-	Plastic top feeder 7,5l Multi-frame
WMT5	WMT5_P	WMT5_Z	Multi-frame American Langstroth, Dadant US, body ½
WMT4	WMT4_P	WMT4_Z	Multi-frame, American Langstroth body
M8060	-	-	Multi-frame plastic low bottom board, hygenic

CHOOSE YOUR COLOR



MULTI-FRAME 10 FRAMES AMERICAN LANGSTROTH BEEHIVE			
not painted	orange	green	
MT102	MT102_P	MT102_Z	low roof, ½ body x2, body x 1, top feeder 2 x 4,5l, low bottom board
MT103	MT103_P	MT103_Z	high roof, body x 2, plastic top feeder 7,5l, low bottom board

## OPTIONAL ELEMENTS TO MULTI-FRAME BEEHIVES, 10 FRAMES



M3145A	Entrance reducer with full closure, 375 mm, Multi-frame
M3149	Multi-frame plastic beehive landing board with plug
M8049	Multi-frame low bottom board drawer
M3048	Trapezoidal ventilation plug Multi-frame
M4035	Stainless steel stand for Multi-frame bottom boards



# MULTI-FRAME 6-FRAMES DADANT BEEHIVE

- roof
- body (inner dimensions): 230×450×295 mm
- low plastic bottom board

- Frame dimensions:
- Dadant: 470×300 mm



COMPONENTS FOR MULTI-FRAME 6-FRAMES DADANT BEEHIVE			
not painted	orange	green	
WMT11	WMT11_P	WMT11_Z	Multi-frame low roof, 6 frames
WMT14	WMT14_P	WMT14_Z	Multi-frame Dadant 6 frames hive body
M8061	-	-	Multi-frame plastic low bottom board, 6 frames, hygenic

MULTI-FRAME 6-FRAMES DADANT BEEHIVE			
not painted	orange	green	
MT111	MT111_P	MT111_Z	low roof, hive body x 1, low plastic bottom board

# MULTI-FRAME 6-FRAMES DADANT US BEEHIVE

- roof
- body (inner dimensions): 230×465×280 mm
- low plastic bottom board

- Frame dimensions:
- Dadant US: 482×285 mm



COMPONENTS FOR MULTI-FRAME 6-FRAMES DADANT US BEEHIVE			
not painted	orange	green	
WMT11	WMT11_P	WMT11_Z	Multi-frame low roof, 6 frames
WMT15	WMT15_P	WMT15_Z	Multi-frame Dadant US 6 frames hive body
M8061	-	-	Multi-frame plastic low bottom board, 6 frames, hygenic

MULTI-FRAME 6-FRAMES DADANT US BEEHIVE			
not painted	orange	green	
MT112	MT112_P	MT112_Z	low roof, hive body x 1, low plastic bottom board

# MULTI-FRAME 6-FRAMES AMERICAN LANGSTROTH BEEHIVE

- roof
- body (inner dimensions): 230×486×229 mm
- low plastic bottom board

- Frame dimensions:
- American Langstroth: 482×232 mm



COMPONENTS FOR MULTI-FRAME 6-FRAMES AMERICAN LANGSTROTH BEEHIVE			
not painted	orange	green	
WMT11	WMT11_P	WMT11_Z	Multi-frame low roof, 6 frames
WMT13	WMT13_P	WMT13_Z	Multi-frame, American Langstroth body, 6 frames
M8061	-	-	Multi-frame plastic low bottom board, 6 frames, hygenic

MULTI-FRAME 6-FRAMES AMERICAN LANGSTROTH BEEHIVE			
not painted	orange	green	
MT110	MT110_P	MT110_Z	low roof, hive body x 1, low plastic bottom board

## OPTIONAL ELEMENTS TO MULTI-FRAME BEEHIVES, 6 FRAMES



M8048



M8061

WMT12



<b>WMT12</b>	Multi-frame body feeder, 6 frames, not painted
<b>M8061</b>	Multi-frame plastic low bottom board, 6 frames, hygienic
<b>M8048</b>	Multi-frame low bottom board drawer, 6 frames
<b>M1058</b>	Entrance reducer with plastic slider for low plastic bottom board drawer, 6-frames, Multi-frame

## INSULATING PARTITIONS



Insulating partitions play a key role in maintaining stable thermal conditions that support the health and development of the bee colony.

Thanks to their specialized design, they help maintain the internal hive temperature at around 34.5 °C, which is ideal for brood rearing.

Partitions protect the brood area from cold in winter and overheating in summer, while still allowing for proper ventilation. Their use reflects a modern approach to beekeeping management, increasing colony survival rates and supporting strong spring development.

- Aluminum foil coating reflects radiant heat, helping stabilize internal temperature throughout the year.
- Lightweight and durable structure – easy to install and resistant to moisture.

Partitions do not cause excessive moisture buildup inside the hive when provided proper ventilation is ensured (e.g. through a bottom board).

<b>W1029IZO_X</b>	Partition tightening, insulating Dadant polystyrene, unpainted
<b>W1078IZO_X</b>	Partition tightening, insulating Dadant-US polystyrene, unpainted
<b>W1179IZO_X</b>	Partition tightening, insulating Langstroth American polystyrene, unpainted

# EUROPEAN DADANT BEEHIVES

European Dadant beehive set

- high roof
  - body ½ - 375×450×174mm (inner dimensions) - without notches, 2 pcs
  - body (inner dimensions): 375×450×310mm
  - high varroa bottom board
  -
- Frame dimensions:
- Dadant: 470×300 mm
  - Dadant ½ (SIZE B): 470×159 mm



COMPONENTS FOR EUROPEAN DADANT		
Painted	Not Painted	
W1101	W11010	Roof
W1143	W11430	Body ½ without notches
W1144	W11440	Body without notches
W1194	W11940	High varroa bottom board
W1052	W10520	Distance ring
W1097	W10970	Body feeder with function of the distance ring
W1195	W11950	Pollen trap

EUROPEAN DADANT BEEHIVE		
Painted	Not Painted	
W1142	W11420	Roof, 2 x body ½, 1 x body, high bottom

# DADANT BLATT BEEHIVES (FRANKENBEUTE)

Dadant Blatt hive set

- roof
  - body ½ (inner dimensions) 450×400×170 mm - 2 pcs
  - crown board
  - body (inner dimensions) 450×400×285 mm
  - high varroa bottom board
- Frame dimensions:
- Dadant Blatt: 470×300 mm
  - Dadant Blatt ½: 470×159 mm
  - Dadant: 470×300 mm
  - Dadant ½ (SIZE B): 470×159 mm



COMPONENTS FOR DADANT BLATT		
Painted	Not Painted	
W1063	W10630	Roof
W1059	W10590	Body ½
W1061	W10610	Crown board
W1058	W10580	Body
W1064	W10640	High varroa bottom board

DADANT BLATT BEEHIVE (FRANKENBEUTE)		
Painted	Not Painted	
W1066	W10660	Roof, 2 x body ½, 1 x body, high varroa bottom board

# AMERICAN LANGSTROTH BEEHIVES

American Langstroth beehive set

- cover
- body (inner dimensions): 370×465×220 mm
  - 2 pcs
- high varroa bottom board

Frame dimensions:

- 482×450×232 mm



COMPONENTS		
Painted	Not Painted	
W1101	W11010	Roof
W1100	W11000	Body without notches
W1194	W11940	High varroa bottom board
W1052	W10520	Distance ring
W1097	W10970	Body feeder with function of the distance ring
W1195	W11950	Pollen trap
-	W11970	Crown board

AMERICAN LANGSTROTH BEEHIVE		
Painted	Not Painted	
W1107	W1103	roof, 2 x body, high bottom

# 8-FRAME LANGSTROTH BEEHIVES

American Langstroth beehive set

- roof
  - body 3/4
    - (inner dimensions)
    - 330×465×170mm
  - body (inner dimensions)
  - 330×465×227 mm
  - high varroa bottom board
- Frame dimensions:
- 482×450×232 mm
  - 3/4: 482×450×170 mm



COMPONENTS		
Painted	Not Painted	
W022	W0220	Roof
W023	W0230	Body
W024	W0240	Body 3/4
W026	W0260	Body 1/2
W021	W0210	Bottom
W025	W0250	Crown board

AMERICAN LANGSTROTH BEEHIVE		
Painted	Not Painted	
W1575	W15750	roof, 1 x body, 1 x body 3/4, bottom

# BEEKEEPING SCALE WITH BLUETOOTH OPTIMA LINE

OPTIMA  
line

The application allows to monitor honey gains and losses in the hive, displays the scale status, and provides battery level information. A daily measurement taken at 8:30 PM is saved in memory — up to 21 records. The app connects to the hive scale via Bluetooth.



## NO GSM SUBSCRIPTION REQUIRED

Bluetooth connection with range up to 30 m



## 21-DAY MEASUREMENT HISTORY

Automatic daily readings at 8:30 PM



## HIVE RECORD BOOK

Ability to record hive inspection notes



## Key features of the app:

- Automatic daily measurement at 8:30 PM
- Option for manual measurements
- Measurement history up to 21 days
- Easy connection between scale and phone via Bluetooth
- User-friendly interface
- Hive record book

## Hive Scale with Bluetooth Interface

- Made of galvanized steel
- Measurement range up to 150 kg
- Battery powered (6 × AA)
- Battery life approx. 4 months
- Communication via Bluetooth

ID	NAME
W3120_OB	Beekeeping scale with bluetooth Optima Line

# ELECTRONIC BEEKEEPING GSM SCALE OPTIMA LINE

OPTIMA  
line

- Features:
- stable and durable mechanical construction made of galvanised steel
- max load of 150 kg
- accuracy  $\pm 10g$
- battery power supply (6 × AA)
- information gathering via SMS
- configuration from the local keyboard and display
- built in anti-theft protection
- Work mode:
- 1 measurement per day
- The set includes:
- frame, with weighing sensor
- control panel with built-in keyboard and display
- works with 4G services



W3120\_O

GSM scale OPTIMA

# ELECTRONIC BEEKEEPING GSM SCALE PREMIUM LINE

**PREMIUM**  
line

**Features:**

- Stable and durable mechanical construction made of stainless steel
- stainless steel top
- max load 150 kg
- accuracy ±10g
- battery powered
- data feed options: SMS, free online data server, main LCD display
- configured using built in control panel
- built in anti-theft protection
- local memory for last 20 read-outs
- optional temperature and humidity sensor
- optional temperature sensor
- power - gel battery with 9Ah capacity and 12DC voltage

**Work modes:**

- 1 measurement per day
- 2 measurements per day
- 3 measurements per day



**Set contents:**

- frame, with stainless top and weighing sensor
- control unit with keyboard and LCD display
- battery and charger

<b>W3122_P</b>	GSM scale - Premium Line
<b>W3122_A</b>	Additional battery (optional)

# COVER FOR BEEKEEPING SCALE

- Waterproof polyester material
- Four zippers
- Dimensions 500×460×220 mm

Cover is designed to protect against theft and adverse weather conditions. For zippers help to put on quickly and give easy access to scale.

Photos are for illustrative purposes only



<b>W3119</b>	Cover for beekeeping scale
--------------	----------------------------

# OTHER ELEMENTS FOR BEEKEEPING SCALE

**W3118**



**W3122\_CZ**



**W3122\_CZT**

ID	NAME
<b>W3122_CZ</b>	Optional external temperature and humidity sensor
<b>W3122_CZT</b>	Optional external temperature sensor
<b>W3118</b>	Solar charger for PREMIUM scale battery

# BEEKEEPING TRAILER WITH PLATFORM SCALE



The hive trailer is a great convenience for any beekeeper who runs apiaries in different locations. Thanks to it, it is possible to transport the hives safely and comfortably to a place where the forage is more valuable. The trailer is additionally equipped with an apiary scale, which provides information on sudden weight loss of the hive via SMS notifications, as well as reports on current measurements.

**Technical specifications:**

- Cargo box dimensions - 300 x 150 x 35 cm
- Side panel height - 35 cm
- Unladen weight - 315 kg
- Gross vehicle weight - 750 kg
- Payload of the trailer - 435 kg
- Total length - 442 cm
- Platform height from the ground - 66 cm
- Tyre size - 155/70R13
- Axles - 2 pcs.
- Wheels – 4 pcs.



**P\_KPL\_435**

One of the most important assets of the trailer is the GSM\* weighing module, which allows the beekeeper to remotely monitor the weight of the hives and thus draw conclusions about what is happening in his apiary. By monitoring the weight gain of the hives on the platform on a daily basis, the beekeeper can gain information on how the bees are using the forage. The weighing module is also equipped with an anti-theft sensor - in the event of a rapid weight loss, a "MASS LOSS" text message will be sent immediately.



**The GSM weighing module is characterised by:**

- measuring range up to 1000kg (measurement increments of 10g)
- battery power supply (6 xAA) - operating time approx. 3.5 - 4 months
- sending a report via SMS once a day
- automatic "MASS LOSS" alarm in case of overturning the hive or theft
- Polish production

Operating mode 1 measurement per day (the weight measurement report is automatically sent once a day to the specified phone number via text message).



A simple SIM card (prepaid) is needed to run the service. The customer decides on the amount of the card's top-up or possible subscription. Each module is encrypted with a 5-digit PIN. When the power supply is disconnected, it requests the entry of this code.

ID	NAME
<b>P_KPL_435</b>	Beekeeping trailer with side panels and platform scale
<b>P_PRZ_435</b>	Beekeeping trailer with side panels
<b>P_PLA_435</b>	Beekeeping platform scale
<b>P_PLF_435</b>	Beekeeping platform

# SWARM REGISTER

The swarm register patented by our company facilitates control of bee families. Thanks to many years of observation and the idea of a befriended beekeeper, we have created a unique product in the world that should appear in every apiary. The method of this device operation is simple. During their swarming bees want to escape from the hive and head to the exit hole of the register. Under the pressure of bees on the cap it slides down at some point, allowing for bees to leave the hive. This is an important signal for the beekeeper, that the bees got swarmed out.



ID	NAME
L50	Swarm register 1 pc.
L50_5	Swarm register - pack of 5 pcs.
L50_10	Swarm register - pack of 10 pcs.
L50_100	Swarm register - pack of 100 pcs.

# BEEHIVE STAND

Galvanized steel beekeeping rack designated for beehives, creates a comfortable versatile bench.

To set up a bench it is required to have 2 of these stands and 2 wooden beams with dimensions of 40×60 mm. Each stand has adjustable legs which allow positioning of the bench even on uneven terrain. Can accommodate up to 5 hives if the appropriate length of beams is used. This solution is much more cost effective in comparison with separate stands for each individual hive.

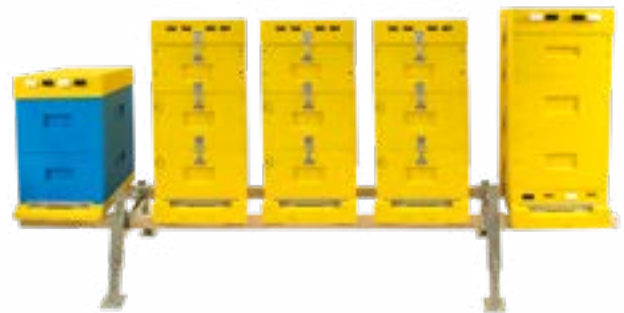

W4033	Beehive stand 1 pc (beams not included)
W4031	Metal stand for hives

# TROLLEYS



WOZEK1



WOZEK3



WOZEK2



WOZEK6

TROLLEY	
WOZEK1	2 wheel hand trolley
WOZEK2	4 wheel platform trolley
WOZEK3	2 wheel platform trolley
WOZEK4	3 wheel trolley
WOZEK5	Trolley for barrel transportation
WOZEK6	Trolley for beehive transportation

# 6-FRAME BEEHIVES FOR NUCS MAKING

- perfect for making nucs
- ensures safe wintering
- the most durable and hygienic bottom board
- bodies with frames - they ensure stability even with more bodies



8056

W1164A\_NIEB

ID	NAME
W1161	Painted 6-frame Dadant beehive - blue (roof, body, plastic bottom board without plugs)
W1161_R	Painted 6-frame Dadant beehive - pink and gray (roof, body, plastic bottom board without plugs)
W1161_Z	Painted 6-frame Dadant beehive - green and gray (roof, body, plastic bottom board without plugs)
W11610	Unpainted 6-frame Dadant beehive (roof, body, plastic bottom board without plugs)
8056	Plastic 6-frame Dadant bottom board with sieves and a latch - without plugs



	NOT PAINTED	BLUE	PINK	GREEN
Dadant body for a 6-frame beehive	W11620	W1162	W1162_R	W1162_Z
Dadant body ½ for a 6-frame beehive, height (frame 145 mm) size A	W11630	W1163	W1163_R	W1163_Z
Dadant body ½ for a 6-frame beehive, height (frame 159 mm), size B	W11630_B	W1163_B_N	W1163_B_R	W1163_B_Z
6-frame Dadant body feeder	W11640A	W1164A_NIEB	W1164A_R	W1164A_ZS

	NOT PAINTED	BLUE	GRAY
Roof for a 6-frame Dadant beehive	W11650	W1165	W1165_SZ
Crown board for 6-frame Dadant beehive	W11640	W1164	W1164_SZ

## 6-FRAME NUCLEUS BEEHIVES

Metal wire fasteners hold the elements in place during transit or bad weather conditions i.e. wind or heavy rain. The roof and the bottom board are equipped with adjustable ventilation holes that allow adjustment of the air flow in the hive (ID 3046, 3047, 3048). The construction of the hive allows wintering of the bees.

Set components:

- high roof
- body
- bottom board with plastic entrance reducer



Painted	Not Painted	
W11300D	W11300	6-frame nucleus hive Dadant (bottom, body, top)
W11300B	W11300K	6-frame nucleus hive Dadant (bottom, body, top), not painted, with clamps
-	W1130	6-frame nucleus hive Langstroth (bottom, body, top)
W113000M	W113000	6-frame nucleus hive Zander (bottom, body, top)
-	3131	Feeder for 6-frame nucleus hive, plastic – 4 kg

## 3-FRAME NUCLEUS HIVES

It can serve as a transport box or swarm box.

The hive is designed for:

- Early spring bee colony production
- natural bee queen insemination with the use of system frames (e.g.: Dadant, Langstroth)

Set components:

- roof
- body
- bottom board with plastic entrance reducer



Painted	Not Painted	
W1189A	W1189	3-frame nucleus hive Langstroth (bottom board, body, roof)
W1191A	W1191	3-frame nucleus hive Dadant (bottom board, body, roof)
W1192DA	W1192D	Feeder for 3-frames nucleus beehive, Dadant
W1192LNA	W1192LN	Feeder for 3-frames nucleus beehive, Langstroth

## PLUGS



Ventilating plugs included as standard to every beehive with ventilation

W3046	Foamed polystyrene, round
W3047	Foamed polystyrene, trapezoid
3048	Plastic, trapezoid



# 6. QUEEN'S BREEDING



# QUEEN INCUBATOR

- Intelligent controller: algorithms
- fuzzy logic technology
- adjustable temperature and humidity
- adjustable air flow
- water level controller
- continuous temperature and humidity monitoring
- advanced self-diagnostic
- adjustable heating power
- Material: stainless steel
- Interior: lit
- Door: double design
- main supply: 230V
- shelf quantity: 3 shelves
- OPTIONAL: GSM Module



<b>W5014</b>	Queen incubator
--------------	-----------------

# INCUBATOR FOR QUEEN CELLS

- power supply 12VDC/15A
- capacity: 45 cages
- outer dimensions: WxDxH- 270x240x165 mm
- power consumption: 30W
- Net weight; 1,9 kg.
- controller IC-03
- temperature range 33-35°C accuracy +/-0,5°C
- airtight, thermally insulated case



<b>W5016</b>	Portable transport incubator for queen cells
<b>5016_1</b>	Foam for 33 isolator- cages for W5016
<b>5016_2</b>	Power supply 230VAC/12VDC for W5016

# MINI NUCLEUS HIVE API EPP

Very durable composition of materials from which the hive is made (EPP material). A 100% recyclable material, resistant to impact and mechanical damage, the material returns to its original shape when pressed. The material is warm to the touch, with excellent thermal insulation.

**SPECIFICATION:**

- 100% recyclable EPP hive
- Removable feeder chamber with a grating element to prevent entry of queen bees
- Ventilation grid on the front
- Adjustable front wall of the hive to open the inlet or the ventilation space
- Removable bottom for easy cleaning
- Feeding chamber and frames are covered with transparent hard foil with a flap

**DIMENSIONS:**

- Height 175mm
- Depth 243mm
- Width 150mm
- Net weight 0.4kg

**Mini nucleus hive components:**

- 3 pcs of plastic frames
- 1 pc of plastic net inserted into the feeder
- 1 pc of ventilation grid at the front of mini nuc hive
- 1 piece of netting limiting the exit of the bee queen
- 1 pc PS board
- 1 pc hatching cage



<b>W1045_B</b>	Mini nucleus hive Api EPP, brown
----------------	----------------------------------

# MINI NUCLEUS HIVE, POLYSTYRENE

Nucleus hive set:

- bottom connected to the body
- 4 frames and a feeding chamber
- roof
- set of small frames - 4 pcs.
- set of 2 entrances with discs

<b>W1044</b>	Mini nucleus hive, polystyrene, painted
<b>W10860</b>	Mini nucleus hive, polystyrene not painted
<b>R02</b>	Frame to the nucleus hive - wooden

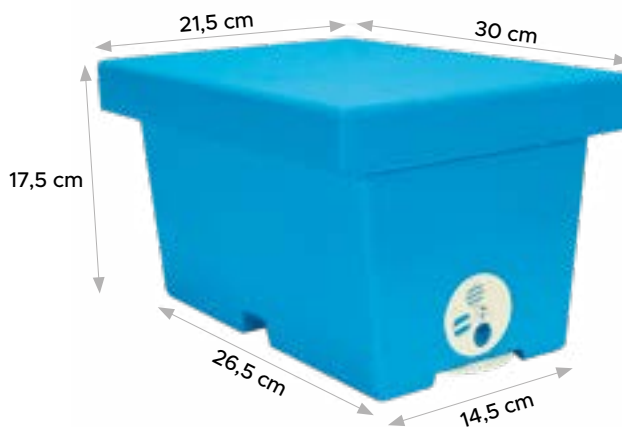

# MINI HIVE 6-FRAME

Mini hive is a 6-frame small hive dedicated to queen breeding. Made of hardened polystyrene.

Mini hive for queen breeding includes:

- top
- feeder
- body (monolit)
- partitions
- bottom-board
- plugs set, external outlet
- set of mini frames - 6 pcs



	not painted	painted
Mini Hive (with frames)	<b>W11109</b>	<b>W11109A</b>
Mini Hive (without frames)	<b>W11109BR</b>	<b>W11109ABR</b>
Mini Hive (with frames) bottom monolit	<b>W111190</b>	<b>W11119</b>
Mini Hive (without frames) bottom monolit	<b>W111190BR</b>	<b>W11119BR</b>
Mini feeder	<b>W11112</b>	<b>W11112A</b>
Mini body (monolit, without frames, with partition)	<b>W11108N</b>	<b>W11108A</b>

Mini bottom-board with ventilation and a set of plugs	<b>W11111</b>	<b>W11111A</b>
Mini bottom-board monolit with ventilation and a set of plugs	<b>W111180</b>	<b>W11118</b>
Roof	<b>W11110</b>	<b>W11110A</b>
Mini partition	<b>W11113</b>	
Frame to mini hive	<b>R01</b>	

# MINI HIVE WITH FEEDER

Mini hive set includes:

- top
- body (monolit)
- build limiter
- feeder
- bottom-board
- a set of plugs
- a set of frames (6 pcs)



	not painted	painted
Mini hive (with frames)	<b>W111050</b>	<b>W11105</b>
Mini hive (without frames)	<b>W111050BR</b>	<b>W11105BR</b>
Mini bottom-board with a drawer	<b>W111150</b>	<b>W11115</b>

Mini body without frames and partitions	<b>W111160</b>	<b>W11116</b>
Roof	<b>W11110</b>	<b>W11110A</b>
Frame to mini hive	<b>R01</b>	

# MINI CLASSIC HIVE FOR MODULAR FRAMES

**Set includes:**

- Mini roof for mini hive
- Mini feeder for mini hive
- Mini body for mini hive
- Mini bottom board for mini hive
- Mini modular frame x 6
- Mini partition for mini hive



The mini CLASSIC hive is the ideal solution for beekeepers looking for a versatile and functional hive for rearing queens or wintering small colonies. Thanks to its innovative modular frames, it allows them to be combined and transferred to a full-size hive as half frames. Its robust construction and thoughtful solutions make it a hive of exceptional durability and practicality.

**ROOF:** The hive's four-sided roof effectively drains water and, thanks to its compatibility with the bottom board, allows the hives to be stacked, which saves space during storage.

**FEEDER:** The two-family feeder enables two bee colonies to be fed simultaneously. This is useful especially during the period of intensive growth or winter feeding.

**MODULAR FRAMES:** Innovative modular frames that allow one 1/2 Dadant frame to be assembled from two mini frames.

**PARTITION:** Possibility to create a two-family body thanks to a special partition, allowing flexible space management.

**TWO-FAMILY BOTTOM BOARD:** A two-family bottom board with two outlets, full closure and landing area provides comfort and safety for the bees. Two independent outlets in the bottom with additional landings.

**MARKING AREA:** An additional marking area for the easy hive numbering.

ID	NAME
W13_UC_X	Mini Dadant CLASSIC hive for modular frames, (frame 145 mm), not painted
W13_UC_N	Mini Dadant CLASSIC hive for modular frames, (frame 145 mm), painted (blue)
W14_UC_X	Mini Dadant CLASSIC hive for modular frames, version B (frame 159 mm), not painted
W14_UC_N	Mini Dadant CLASSIC hive for modular frames, version B (frame 159 mm), painted (blue)

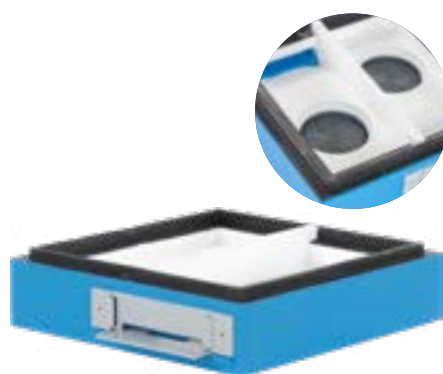

	not painted	painted
Mini roof for mini Dadant CLASSIC hive for modular frames	W11C_X	W11C_N
Mini body for mini Dadant CLASSIC hive for modular frames, height: 159 mm	W14C_X	W14C_N
Mini body for mini Dadant CLASSIC hive for modular frames, height: 145 mm	W13C_X	W13C_N
Mini feeder for mini Dadant CLASSIC hive for modular frames	W15C_X	W15C_N
Mini bottom board for mini Dadant CLASSIC hive for modular frames	W16C_X	W16C_N

# ADDITIONAL ACCESSORIES FOR MINI CLASSIC BEEHIVE



W18C\_X



W100C

W102C

ID	NAME
W18C_X	Mini partition for mini Dadant CLASSIC hive for modular frames, height: 145 mm, not painted
W19C_X	Mini partition for mini Dadant CLASSIC hive for modular frames, height: 159 mm, not painted
W100C	Building limiter for mini bottom board of Dadant CLASSIC mini hive for modular frames
W102C	Separator foil for frames of Dadant Classic mini hive, height 145 mm/159 mm
R04	Mini modular frame for mini Dadant CLASSIC hive, height: 145 mm
R05	Mini modular frame for mini Dadant CLASSIC hive, version B, height: 159 mm
3175	Plastic latch with entrance reducer for the mini CLASSIC hive's bottom board, full closure
3375	Entrance reducer for the mini CLASSIC hive's bottom board, full closure

# POLISH OPALITH

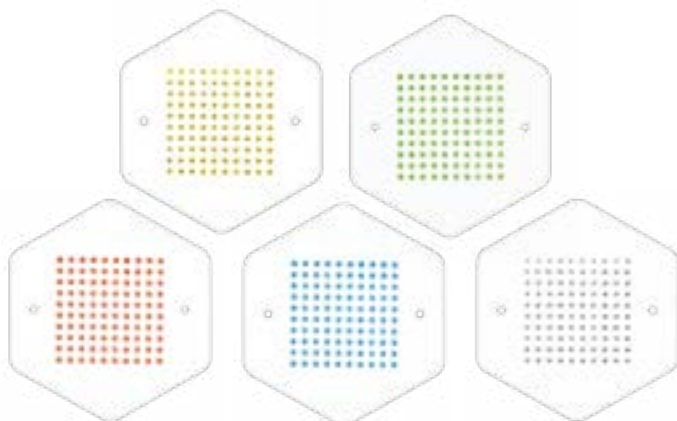

ID	NAME
OPAL5	Polish opalith – 5 colours
OPALB	Polish opalith – one colour – white
OPALC	Polish opalith – one colour – red
OPALN	Polish opalith – one colour – blue
OPALY	Polish opalith – one colour – yellow
OPALZ	Polish opalith – one colour – green

# TRAVELING BOXES

Traveling box is used for moving whole families/frames.

<b>W0153</b>	Traveling box Dadant, polystyrene, painted
<b>W0153N</b>	Traveling box Dadant, polystyrene, not painted
<b>W1069D</b>	Traveling box Dadant (cardboard)
<b>W1069LN</b>	Traveling box Langstroth (cardboard)



- new, improved design
- can be attached to each other



**3005**  
Queen cage



**3008**  
Hatching cage



**FS546**  
Silicone mold for wax queen cell cup making (42pcs)



**3106**  
Grafting tool (standard)



**3004**  
Cage for queen storage



**W3043**  
Glue for queen stickers 5 ml



**3143**  
Queen marking tube



**3080**  
Queen catcher



**30010**  
Plastic queen catcher



**3097**  
Marking ring



**3129**  
Queen marking set (strainer+insert)



**3079**  
Cap for queen rearing



**3012**  
Slat with queen cups (2 pcs)



**3011**  
Queen cup fixing slot



**3030**  
Queen cup with slot holder, 12 pcs



**3013**  
Queen-cell cup, 200 pcs  
**3014**  
Plastic cup (50 pcs)

# ROYAL JELLY PUMPS

Device allows collection of royal jelly from cells in a quick and effective way.

Efficiency 10ml/1min

## W011

Royal Jelly Pump 12V

- Power: 15W
- Width 280 mm
- Length 270 mm
- Height 165 mm

Components:

- 5 pcs of 100 ml bottles
- 2 Wires connection
- 1 Power cord
- 1 Glass suction nozzle

## W010

Royal Jelly Pump 230V

- Power: 20W
- Width 280 mm
- Length 270 mm
- Height 165 mm

Components:

- 5 pcs of 100 ml bottles
- 2 Wires connection
- 1 Power cord
- 1 Glass suction nozzle



ROYAL JELLY PUMPS	
W011	12V
W010	230V

# OXALIC ACID SUBLIMATORS

**Oxalic acid sublimator 12V**

- Power supply – 12V
- Heating power – 160W
- 20 A fuse (located on the cable)
- Thermoregulator
- Power supply cord length – 2,5 m
- Dimensions
- Length 420, width 70, height 160 mm



ID	NAME
D12V	Oxalic acid sublimator 12V

**Oxalic acid sublimator 230V**

- Power supply – 230V
- Heating power – 250W
- Thermoregulator
- Power supply cord length – 2,5 m
- Dimensions
- Length 420, width 70, height 160 mm



ID	NAME
D230V	Oxalic acid sublimator 230V

# MANUAL FUMIGATOR



without the use of electricity



secure your apiary



get rid of Varroa



ID	NAME
W3010	Manual fumigator

# 7. BEEKEEPING TOOLS



# BEEKEEPING TOOLS

## IN A NEW EDITION



### SMOKERS

- new design
- improved airflow and higher efficiency
- aesthetic and durable bellow band
- made in Poland



## BEEKEEPING TOOLS

### - ESSENTIAL IN YOUR APIARY!

- ergonomically shaped for comfortable use
- made of high-quality stainless steel and coated steel
- modern and functional design
- made in Poland



## DON'T MISS OUT!

Ask our sales representative about a dedicated display stand for Lyson beekeeping tools!

## SMOKERS



4032M	Smoker with heat shield, small, galvanized
4032	Smoker with heat shield, galvanized, H 32 cm
4036	Smoker with heat shield, stainless
4036M	Smoker with heat shield, small, stainless
4057	Smoker, big, acid-resistant with cooler
4057M	Smoker, small with cooler
4059	Copper smoker

## SMOKER PREMIUM



4045	Acid-resistant stainless steel
4017P	Bellow, PREMIUM

## ACCESSORIES

4017N	Bellow, stainless steel, leather
4017MN	Bellow, small, leather, stainless steel
40172	Bellow for copper smoker
4093	Smoker insert 4032
4094	Smoker insert 4032M
4087	Smoker insert 4036, 4057
4088	Smoker insert 4036M, 4057M
4046	Handle

## SMOKERS WITH PREMIUM BELLOWS



40091

40092



4032\_P

4036\_P

ID	NAME
40091	Galvanized smoker with PREMIUM bellow, without cooler, Ø 11,5 cm
40092	Stainless smoker with PREMIUM bellow, without cooler, Ø 11,5 cm
4032_P	Galvanized smoker with PREMIUM bellow, with cooler, height: 31,5 cm
4036_P	Stainless smoker with PREMIUM bellow, with cooler, height: 31,5 cm

## AMERICAN HIVE TOOLS WITH HANDLE



BT 10A1

BT 010A	(H: 270mm, W: 45mm ), painted
BT 10A1	(H: 270mm, W: 45mm ), stainless

## MULTI FUNCTIONAL HIVE TOOLS



BT 10O1

BT 10R1	(H: 265mm, W: 45mm ), stainless
BT 010O	with handle (H: 265mm, W: 45mm), painted
BT 10o1	with handle (H: 265mm, W: 45mm), stainless

## HIVE TOOLS WITH HANDLE

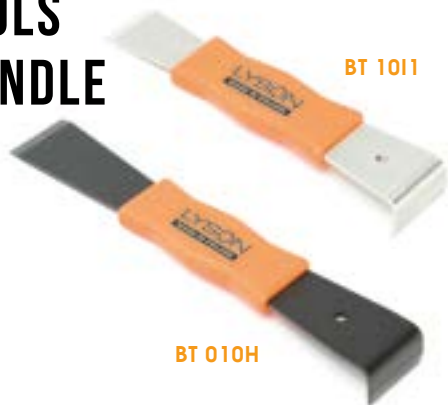

BT 10I1

BT 010H

BT 10I1	Medium (H: 205mm, W: 40mm), stainless
BT 010H	Long (H: 260mm, W: 40mm), painted
BT 10H1	Long (H: 260mm, W: 40mm), stainless

## AMERICAN HIVE TOOLS



BT 10T1

BT 10S1

BT 10D1

BT 10T1	Short (H: 160mm, W: 40mm), stainless
BT 10S1	Medium (H: 210mm, W: 30mm), stainless
BT 010D	Long (H: 270mm, W: 45mm), painted
BT 10D1	Long (H: 270mm, W: 45mm), stainless

## SYNTHETIC BRISTLE BEE BRUSHES



3034O.

3034P.

3034O.	Long bee brush, plastic handle
3034P.	Short bee brush, plastic handle

## NATURAL BRISTLE BEE BRUSHES



3034Q.

3034R.

3034Q.	Long bee brush, plastic handle
3034R.	Short bee brush, plastic handle

# 8. REMAINING BEEKEEPING ACCESSORIES



## UNCAPPING TRAYS



W4044

UNCAPPING TRAY	
W40710	galvanized (42×42×4 cm)
W4044	stainless (42×42×4 cm)

## UNCAPPING PLASTIC TRAYS



W3233

UNCAPPING PLASTIC TRAY	
W32330	stainless sieve, H=100 mm
W32340	stainless sieve, H=200 mm
W32400	stainless sieve, H=300 mm
W3233	plastic sieve, H=100 mm
W3234	plastic sieve, H=200 mm
W3240	plastic sieve, H=300 mm

## UNCAPPING TRAY, STAINLESS

Uncapping tray made of acid resistant stainless steel with 0,8 mm thickness. Frame holder made of 5 mm stainless steel wire. Stainless steel honey gate 6/4"



W4062	Uncapping tray, stainless, 6/4' honey gate
-------	--

## UNCAPPING TRAY WITH SPIKE

- Plastic tray with plastic honey gate 6/4" (41 cm × 61 cm × 30 cm)
- strainer: plastic with perforation Ø 6 mm
- stainless spike



W3340F	Uncapping tray with spike
--------	---------------------------

## UNCAPPING TRAYS, DUAL-FUNCTION

- Practical in use.
- After uncapping, you can dismantle the frame holder from the cover and cover the tray with it.

The cover has 2 functions:

- practical stand for 10 uncapped frames
- tray cover
- Components:
- Plastic tray (41 cm × 61 cm × 20 cm)
- Strainer - stainless steel with perforated bottom (inside dimensions: 34,5 cm × 55 cm × 7 cm)
- Stainless steel lid with support for 10 frames

UNCAPPING TRAY, DUAL-FUNCTION	
W32401	Uncapping tray
W32401S	Uncapping tray with stand



# UNCAPPING TABLES WITH PLASTIC TRAY

Tray dimensions:

length: 61 cm, width: 41 cm, height: 10, 20, 30 cm

- max table height (stand only): 72 cm (adjustable legs)

UNCAPPING TABLE WITH PLASTIC TRAY	
<b>W4048N</b>	stainless sieve, H=100 mm
<b>W4049N</b>	stainless sieve, H=200 mm
<b>W4050N</b>	stainless sieve, H=300 mm



# UNCAPPING TOOLS



**4200** Uncapping fork, wooden handle, straight tines



**4022** Uncapping fork with wooden handle, curved tines



**4202** Uncapping fork, curved tines, stainless, plastic handle



**4040** Uncapping knife, stainless steel

# HONEY LOOSENERS



**30280**



**302700**



**3027000**

HONEY LOOSENER	
<b>30280</b>	Manual honey loosener
<b>3027000</b>	large, plastic needles
<b>302700</b>	small, plastic needles

## STAINLESS STRAINERS



4006



4007

STAINLESS STRAINER	
4006	Single strainer, Ø 205 mm
4034	Single strainer, convex, Ø 205 mm
4007	Double strainer, Ø 205 mm
4100	Double strainer, convex, Ø 205 mm

## METAL STRAINERS



4030



4098

METAL STRAINER	
4014	Single strainer, Ø 205 mm
4030	Single strainer, convex, Ø 205 mm
4098	Double strainer, convex, Ø 205 mm
4013	Double strainer, Ø 205 mm

## CONICAL STRAINERS

CONICAL STRAINER	
3222	Ø 310 mm, H - 390 mm
3222A	Ø 310 mm, H - 230 mm
3222B	Ø 450 mm
32220	Ø 625 mm, H - 290 mm, for barrel
3069	Ø 295 mm, with stand
W3221	Stand for conical strainer



3222

## CYLINDRICAL STRAINERS



3164

3166

## STAND FOR CYLINDRICAL STRAINER, DIAMETER 45 CM, ADJUSTABLE

Dimensions:

- width - 435 mm.
- depth - 435 mm.
- height - 1000 mm.

Weight:

- net weight - 3.30 kg



W3225

CYLINDRICAL STRAINER	
3068	Ø190 mm
3164	Ø300 mm
3166	Ø400 mm
W3223	Stainless steel stand for cylindrical strainer Ø300 mm
W3224	Stainless steel stand for cylindrical strainer Ø400 mm
4058	Double strainer, nylon, Ø 290 mm
W3222	Stainless steel stand for cylindrical strainer

## POLYPROPYLENE PAILS



POLYPROPYLENE PAILS	
<b>7007</b>	Capacity 11,3 l
<b>7006</b>	Capacity 17,7 l
<b>7005</b>	Capacity 31,5 l

## POLYPROPYLENE SETTLING TANKS WITH PLASTIC VALVE



**W7004**

POLYPROPYLENE SETTLING TANKS WITH PLASTIC VALVE	
<b>W70070</b>	Capacity 11,3 l, with valve 6/4"
<b>W7003</b>	Capacity 17,7 l, with valve 6/4"
<b>W7004</b>	Capacity 31,5 l, with valve 2"

## VALVES



**3033**

VALVES	
<b>3033</b>	6/4" plastic
<b>3000</b>	2" plastic
<b>W40320</b>	5/4" stainless, internal thread
<b>W4032</b>	5/4" stainless, external thread
<b>W40840</b>	6/4" stainless, internal thread
<b>W4084</b>	6/4" stainless, external thread
<b>W40850</b>	2" stainless, internal thread
<b>W4085</b>	2" stainless, external thread
FLAP FOR VALVE	
<b>3140A</b>	Flap for 2" valve, stainless (5mm)
<b>31400</b>	Flap for 5/4" and 6/4" valve, stainless (3mm)
<b>5090</b>	Flap for 6/4" valve, plastic
<b>50900</b>	Flap for 2" valve, plastic

## STAINLESS STEEL BARREL 200 L



**W7016**

<b>W7016</b>	Stainless steel barrel 200 l / ~280 kg
<b>3227</b>	Sack for honey barrel 200 l (69×180 cm)

## DRIPPERS

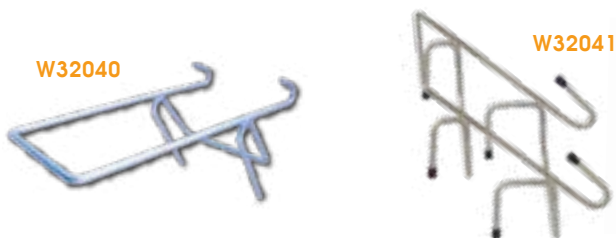

**W32040**

**W32041**

DRIPPER	
<b>W32040</b>	Stainless
<b>W32041</b>	Stainless dripper for honey, universal

## MIXERS



**W4009**

**W4008**

MIXER	
<b>W4009</b>	Drill for syrups melting Ø 60 mm
<b>W4008</b>	Drill for honey creaming Ø 95 mm

## PLASTIC QUEEN EXCLUDERS, THICK



The color is dependent on the batch of material.  
Size tolerance +/- 3mm.

PLASTIC QUEEN EXCLUDER, THICK	
<b>31951W</b>	420×420 mm
<b>31950</b>	Dadant 418×490 mm
<b>31950LA</b>	American Langstroth 420×510 mm

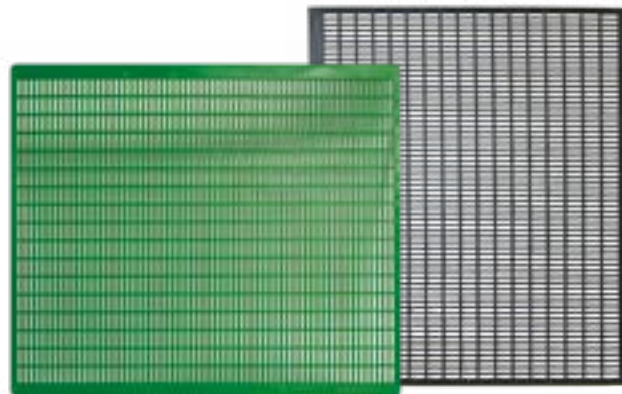

Thick plastic excluders are a low-priced alternative to the metal excluders - they are lighter and as durable.

## PLASTIC QUEEN EXCLUDERS

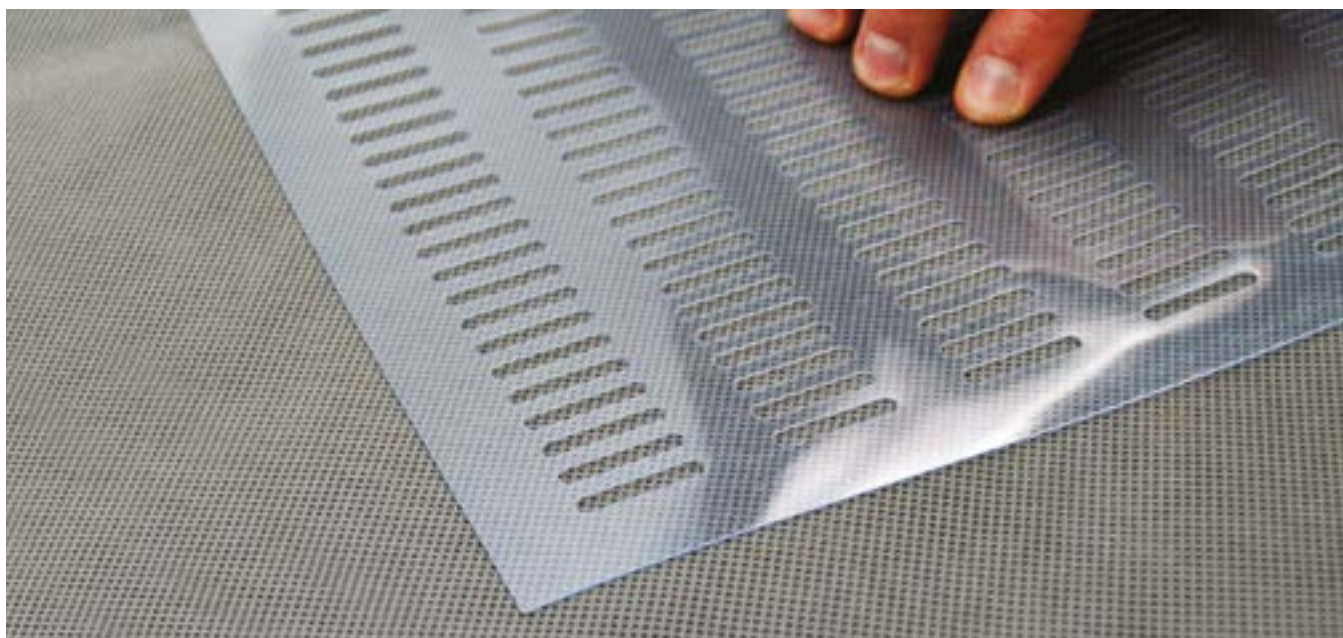

PLASTIC QUEEN EXCLUDER	
<b>3191</b>	Dadant 495×500 mm
<b>3195</b>	Dadant 425×495 mm
<b>3109</b>	420×420 mm



The color is dependent on the batch of material.  
Size tolerance +/- 3mm.

## PLASTIC QUEEN EXCLUDERS, THICK, BLACK

The color is dependent on the batch of material.  
Size tolerance +/- 3mm.



PLASTIC QUEEN EXCLUDER, THICK, BLACK	
<b>31951WCZ</b>	420×420 mm
<b>31950CZ</b>	Dadant 418×490 mm
<b>31950LACZ</b>	American Langstroth 420×510 mm

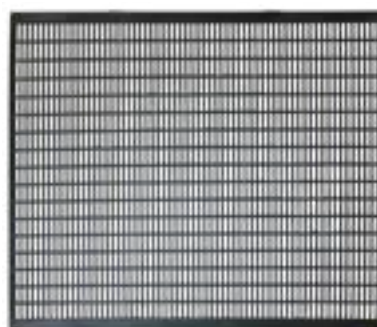

## METAL EXCLUDERS



METAL EXCLUDER	
<b>4000</b>	Dadant, horizontal, with notches, (465 × 390 cm)
<b>4000N</b>	Dadant, horizontal, with notches, (470 × 393 mm)
<b>4001</b>	Dadant, horizontal (470 × 380 mm)
<b>4002</b>	Dadant, vertical (445 × 319 mm)
<b>3999</b>	Langstroth with frame around (510 × 420 mm)

## METAL ISOLATORS

METAL ISOLATOR	
<b>4099</b>	Dadant 1/2 1-frame
<b>4067</b>	Dadant 3-frames
<b>4048</b>	Dadant 1-frame
<b>4067P</b>	Cover for metal-isolator Dadant 3-frames
<b>4051</b>	Metal queen isolator, 2-frames, Dadant
<b>4051P</b>	Cover for metal queen isolator, 2-frames, Dadant



## METAL QUEEN EXCLUDER / ISOLATOR

METAL QUEEN EXCLUDER / ISOLATOR	
<b>1048D</b>	Dadant 1-frame
<b>4051</b>	Metal queen isolator, 2-frames, Dadant
<b>4051P</b>	Cover for metal queen isolator, 2-frames, Dadant

## POLLEN TRAP & SEPARATOR

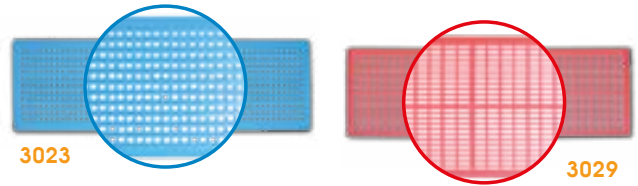
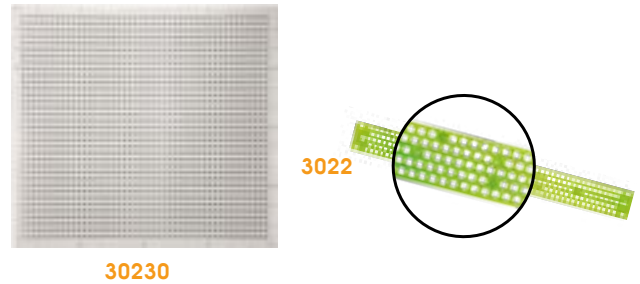

 The color is dependent on the batch of material.

POLLEN TRAP & SEPARATOR	
<b>30230</b>	Pollen catching plate, large, 341 mm x 371 mm
<b>3022</b>	Trap (390 × 40 mm), 5,1 mm
<b>3023</b>	Trap (408 × 148 mm), 5,1 mm
<b>3029</b>	Separator (403 × 148 mm)

## PLASTIC SCRAPER



<b>4031</b>	for excluders, reinforced
-------------	---------------------------



## CLAW HIVE TOOLS



W4029

W4029	Stainless
W40290	Painted

## J-TYPE HIVE TOOLS



W4016

W4016	Stainless
W40160	Painted

## BEE BRUSH WITH NATURAL BRISTLE



3034V

3034V	Long
3034W	Short

## CHISELS WITH WOODEN HANDLE



4116

4115	Galvanized
4116	Stainless

## HIVE TOOL



W4015

W4015	Stainless
W4065	Painted

## OTHER BRUSHES



3034J

BEE BRUSH	
3034E	With a chisel, double
3034J	Wooden with synthetic bristle, double-breasted, long
3034G	Wooden with synthetic bristle, long

## BEE BRUSH FOR CLEANING



3034E



3034M

3034E	Natural bristle
3034M	Synthetic bristle

## BEE BRUSHES WITH PLASTIC HANDLE



3034X

3034X	Synthetic bristle, long
-------	-------------------------

## ENTRANCE REDUCERS



4010

3180

3145

4010	Stainless, 230 mm
4012	Universal, galvanized, 350 mm
3145A	Entrance reducer with full closure, 375 mm
3145	Plastic, with slider, 375 mm
3180	Plastic, 185 mm
1055	Plastic, 375 mm
3179	Plastic
3178	Galvanized, 250 mm
3177	Galvanized, 375 mm
3176	3-parts, galvanized, 375 mm
401000	Stainless, 345 mm

# BEE SWEEPING DEVICE

## W30342

Technical data:

- construction of device made of aluminium sheet
- stepless speed adjustment in the range of 0÷450 RPM
- MDD-01 18V battery control
- brushes activated automatically (optical sensor)
- replaceable brushes made of polyamide bristles 0.15mm thick and 30mm long

Dimensions:

- width - 1080 mm.
- depth - 400 mm.
- height - 650 mm.

Weight:

- net weight – 17 kg

The set includes:

- clear container for bees
- a 2.5 Ah battery
- charger
- Instruction manual



W30342



30341

W30342	Mechanical bee sweeping machine
30341	Manual bee sweeping machine

\*The product photos are demonstrative illustrations and may sometimes differ from the actual appearance of the item. However, this does not alter their basic characteristics

## UPPER FEEDER 3L DADANT



- External dimensions: 41.7 x 48 x 6 cm
- Height of cap: 5 cm
- Diameter of cap: 13 cm
- Feeder capacity: 3 l

<b>3163</b>	Upper feeder with chimney cap, 3 l, Dadant
<b>3163_A</b>	Chimney cap for upper feeder
<b>3163_B</b>	Cover for upper feeder

## UPPER FEEDER 5L



W1123A



- External dimensions - 370x370 mm
- Height - 8,5 cm
- Fits to 1/2 body or under the high roof (W1094W)

<b>3071</b>	Upper feeder 5l
<b>3070</b>	Cover for feeder

## UPPER FEEDER 7,5L DADANT



3086



- External dimensions - 415x485 mm
- Height - 8,5 cm
- Fits to 1/2 body

<b>3086</b>	Upper feeder 7,5l Dadant
<b>3070</b>	Cover for feeder

## BODY FEEDERS



3262

BODY FEEDER	
<b>3074</b>	Box feeder 2,4 l, plastic
<b>3262</b>	Adapter for feeders (3074) 2,4 l
<b>W1123A</b>	Polystyrene, Dadant and Dadant 1/2, Polish Langstroth, painted
<b>W11230</b>	Polystyrene, Dadant and Dadant 1/2, Polish Langstroth, not painted
<b>W11230B</b>	Dadant, Dadant 1/2 body feeder, 10 l, not painted
<b>W1123B</b>	Dadant, Dadant 1/2 body feeder, 10 l, painted

## ROUND FEEDERS



3087

3133

3165

ROUND FEEDER	
<b>3133</b>	Cover for round feeder (4 l)
<b>3165</b>	Round feeder (4 l), Ø: 350 mm, H: 600 mm
<b>3087</b>	Cap for round feeder, 4l
<b>3159</b>	Cover to round feeder (4 l), transparent

## PAIL FEEDERS



3076

PAIL FEEDER	
3076	Pail feeder 5 l Ø: 250 mm, H: 190 mm

## OTHER FEEDERS



3050

3051



3256

FEEDER	
3050	Ring
3051	"Spider's web" plug
3256	Plastic cap with holes (for feeding)

## BEE ESCAPES

The color depends on the batch of raw material



3026



3190



3144

3190	8-way, Ø 26 cm
3148	16-way, Ø 24,5 cm
3026	Porter, (10,5 × 4,3 cm)
3144	Plastic, Ø 12 cm



3148

## CONTAINER FOR FORMIC AND ACETIC ACIDS (EVAPORATOR)

Closeable and with evaporation control. Includes a polyurethane insert of 120 ml capacity.

The color depends on the batch of raw material



3024	Container for formic and acetic acids (evaporator)
------	--

## ROUND LIQUID CRYSTAL THERMOMETER



3001K	Round liquid crystal thermometer
-------	----------------------------------

## WIRES



WIRE	
4018	0,3 mm (250g), galvanized
40190	0,4 mm (250g), galvanized
4062	0,3 mm (500g), galvanized
4061	0,4 mm (500g), galvanized
40640	0,4 mm (250g), stainless
40641	0,4 mm (250g), stainless
40642	0,4 mm (500g), stainless
40643	0,4 mm (500g), stainless
40644	Stainless steel frame wire 0,5mm - 250g
40645	Stainless steel frame wire 0,5mm - 500g

## FRAME SPACERS



FRAME SPACER	
302H	Plastic, hoffman 40 pcs (for 20 frames)
301H	Plastic, hoffman, 140 pcs (for 70 frames)
304H	Plastic, hoffman, 500 pcs (for 250 frames)
3017A	Plastic, 200 pcs
W4026	Metal, 200 pcs
4025	Metal, 1 kg
3102	Plastic, 40 pcs
3015	Plastic, 600 pcs

## WIRE EMBEDDING DEVICE

PRODUCT SPECIFICATIONS:

- supply voltage: 230VAC
- power: 140WAC
- fusing voltage I: 12VAC
- injection voltage II: 24VAC
- max. injection current: 4,75A
- short circuit protection: PTC



The wire embedding device works in two ranges:

- I - galvanized wire
- II - stainless steel wire

Dimensions: length - 200 mm, width - 125 mm, height - 70 mm, net weight - 1.85 kg.

W3362	Wire embedding device
-------	-----------------------

## WIRE DEROLLER



4106	Wire deroller
------	---------------

## PLASTIC BEEHIVE LANDING BOARD WITH PLUG



3149\_Z



3149\_P

3149_P	Plastic beehive landing board with plug, compatible with chosen Lyson plastic/polystyrene crownboards, grey colour
3149_Z	Plastic beehive landing board with plug, compatible with chosen Lyson plastic/polystyrene crownboards, yellow colour
3184	Plastic entrance reducer, Lyson plastic & polystyrene crownboards

## OTHERS

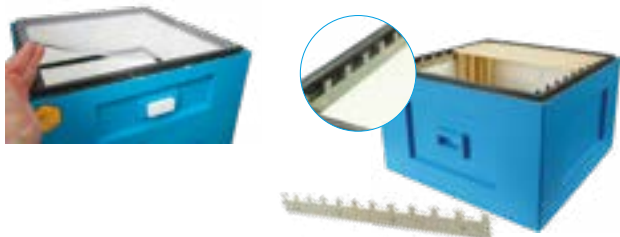

<b>W0170</b>	Frame reduction spacer for Dadant and Langstroth body (from 10 to 9 frames)
<b>3198</b>	Foam ventilation plug

## DADANT STAINLESS BEEHIVE PARTITION

Frame dimensions:  
• 132×112 mm

Dimensions:  
• 472×105 mm



<b>LM28</b>	Dadant stainless beehive partition
-------------	------------------------------------

## FRAME HOLDERS



FRAME HOLDER	
<b>W32610W</b>	Stainless, Deutsch Normal
<b>W32610D</b>	Stainless, Dadant

## TRAPS



<b>3103</b>	Trap for hornets
<b>3101</b>	Trap for wasps

## OTHERS

The color depends on the batch of raw material



## WOODEN FRAMES

WOODEN FRAME	
<b>30350</b>	Distance beam for Dadant frames (50 pcs)
<b>3054K</b>	Dadant frame 1/2 Hoffman 435×145 (10 pcs)
<b>3055K</b>	Dadant frame 1/2 standard 435×145 (10 pcs)
<b>3056K</b>	Dadant frame Hoffman 435×300 (10 pcs)
<b>3057K</b>	Dadant frame standard 435×300 (10 pcs)

## FRAME GRIP



<b>3117</b>	With ergonomic handle, reinforced
<b>1056</b>	Stopper for the bottom

<b>3130</b>	Hive numbers
<b>3019</b>	Hive strap (3.5m)
<b>3020A</b>	Hive transport belt (2t/4m, 1pc)
<b>3032</b>	Swarm catcher
<b>3130_P</b>	Hive numbers - white
<b>3130_B</b>	Hive numbers - blue
<b>3130_N</b>	Hive numbers - orange
<b>3046</b>	Plug, foamed polystyrene, round
<b>3047</b>	Plug, foamed polystyrene, trapezoid
<b>3048</b>	Plastic ventilation plug, trapezoid
<b>MF5</b>	Thick felt mat 1000 g/m <sup>2</sup> 50X42 cm - Dadant

## EXTRACTOR MOTOREDUCTORS



When placing order please provide extractor model. In case of top mounted drive systems there is additional mounting flange necessary.

## CASSETTE FOR EXTRACTORS



When placing order please provide extractor model and type of used frame.



## MOTORS



When placing order please provide extractor model.

## 24V DC MOTOR



## MANUAL DRIVE SET WITH BRAKE



When placing order please provide extractor model.

## TANGENTIAL ADAP- TOR FOR RADIAL EXTRACTORS



## EXTRACTOR SPRING SET

- 1) 65 mm conical,
- 2) 75 mm conical,
- 3) 85 mm conical

- 1) 65mm straight
- 2) 75mm straight



When placing order please provide extractor model.



## CASSETTE REDUCER INSERT

To reduce the size of extractor's cassette in case of extracting honey from smaller frames.

## SPARE WORM GEAR COG SET



Big: Ø73/Ø15/33 teeth  
Small: Ø24/Ø12/10 teeth

## CAPPINGS BAG FOR EXTRACTORS



## EXTRACTOR BASKETS

EXTRACTOR BASKETS	
3-frame basket	
4-frame basket	
5-frame basket	
Radial basket for Ø720 mm extractor	
Radial basket for Ø800 mm extractor	
Radial basket for Ø900 mm extractor	
Radial basket for Ø1000 mm extractor	
Radial basket for 1200 mm extractor	
4-cass. DN for Ø720 mm extractor	
4-cass. LN for Ø720 mm extractor	
4-cass. D for Ø800 mm extractor	
6-cass. DN for Ø800 mm extractor	
6-cass. LN for Ø800 mm extractor	
6-cass. D for Ø1000 mm extractor	
8-cass. DN for Ø1000 mm extractor	
8-cass. LN for Ø1200 mm extractor with partitions	
8-cass. D for Ø1200 mm extractor with partitions	
12-cass. D for Ø1000 mm extractor with partitions	
12-cass. DN for Ø1000 mm extractor with partitions	
12-cass. LN for Ø1200 mm extractor with partitions	
16-cass. DN for Ø1200 mm extractor with partitions	
16-cass. LN for Ø1200 mm extractor with partitions	
20-cass. DN for Ø1200 mm extractor with partitions	
20-cass. LN for Ø1200 mm extractor with partitions	

## POWER ADAPTOR WITH WIRE EMBEDDING FUNCTION

- Dedicated for 12V electric honey extractors
- 230V input voltage with an option of 110V
- Output voltage 12V
- Power 250W
- Max current 21A

<b>W3305</b>	Power adaptor 230V/12V (power 400W) to extractors MINIMA with dimension Ø 800-1000mm
--------------	--

## ACRYLIC GLASS COVERS

ACRYLIC GLASS COVERS	
Extractor diameter Ø500 mm, (set - 3 mm)	
Extractor diameter Ø600 mm, (set - 3 mm)	
Extractor diameter Ø720 mm, (set - 5 mm)	
Extractor diameter Ø800 mm, (set - 5 mm)	
Extractor diameter Ø900 mm, (set - 5 mm)	
Extractor diameter Ø1000 mm, (set - 5 mm)	
Extractor diameter Ø1200 mm, (set - 5 mm)	

## HONEY PUMPS' ACCESSORIES

PIPE HOLDER	
<b>W32600</b>	stainless, Ø40 mm
<b>W32601</b>	stainless, Ø50 mm
<b>W32600_50</b>	stainless, Ø40 mm
<b>W32601_50</b>	stainless, Ø50 mm
PUMP HOSE	
<b>5023</b>	Ø40 mm (1 meter)
<b>5024</b>	Ø50 mm (1 meter)
<b>5025</b>	Ø60 mm (1 meter)
ACCESSORIES	
<b>110030</b>	Honey pump impeller 0,37kW
<b>110031</b>	Honey pump impeller 1,5kW
<b>307004</b>	Set of seals for honey pump and honey bottler



If you need spare parts for your equipment, please contact our distributor or contact us directly [globalsales@lyson.com.pl](mailto:globalsales@lyson.com.pl)

# 9. CLOTHING FOR BEEKEEPERS



# CLOTHING FOR BEEKEEPERS COLOR & PREMIUM LINE

## BEEKEEPING SUITS



COLOR  
line

**Available sizes:** XS - XXXXL

**Fabric:** 65% polyester, 35% cotton

**Available colors:** salmon, purple, blue, turquoise

Made of high-quality fabrics

Fabric thickness: 185 g / m<sup>2</sup>

Practical tailored pockets

Elastic cuffs and leg ends

Double support rings in the hat keep the veil at a safe distance from the face

Detachable hat



M6056F

M6056N

M6056T

M6056L

M6056L	Beekeeping suit with hat - salmon
M6056F	Beekeeping suit with hat - purple
M6056N	Beekeeping suit with hat - blue
M6056T	Beekeeping suit with hat - turquoise
60380F	Replacement hat - salmon
60380T	Replacement hat - purple
60380N	Replacement hat - blue
60380L	Replacement hat - turquoise

## BEEKEEPING JACKETS AND TROUSERS

COLOR  
line



M6057T

M6057N

M6057L

M6057F

M6057G

M6057S1

M6057S2

M6040T

M6040N

M6040L

M6040F

M6040G

M6040S1

M6040S2



Size charts  
on page 251

## BEEKEEPING JACKETS

**Available sizes:** XS - XXXXL

**Fabric:** 65% polyester, 35% cotton

**Available colors:** salmon, purple, blue, turquoise, glamour, style sport M1, style sport M2

Back of the hat made of veil

Practical, tailored pockets

Elastic cuffs

Double support rings in the hat keep the veil at a safe distance from the face

Detachable hat

<b>M6057L</b>	Jacket with hat, zipper - salmon
<b>M6057F</b>	Jacket with hat, zipper - purple
<b>M6057N</b>	Jacket with hat, zipper - blue
<b>M6057T</b>	Jacket with hat, zipper - turquoise
<b>M6057G</b>	Jacket with hat, zipper - beige glamour
<b>M6057S1</b>	Jacket with hat, zipper - sport style - M1
<b>M6057S2</b>	Jacket with hat, zipper - sport style - M2
<b>60380F</b>	Spare hat - salmon
<b>60380T</b>	Replacement hat - purple
<b>60380N</b>	Replacement hat - blue
<b>60380L</b>	Replacement hat - turquoise
<b>60380G</b>	Replacement hat - beige glamour
<b>60380S1</b>	Replacement hat - sport style - M1
<b>60380S2</b>	Replacement hat - sport style - M2

## BEEKEEPING TROUSERS

**Available sizes:** XS - XXXXL

**Fabric:** 65% polyester, 35% cotton

**Available colors:** salmon, purple, blue, turquoise, glamour, style sport M1, style sport M2

Practical, tailored pockets

Elastic leg ends



Size charts  
on page 251

<b>M6040L</b>	Trousers, salmon
<b>M6040F</b>	Trousers, purple
<b>M6040N</b>	Trousers, blue
<b>M6040T</b>	Trousers, turquoise
<b>M6040G</b>	Trousers, beige glamour
<b>M6040S1</b>	Trousers, sport style - M1
<b>M6040S2</b>	Trousers, sport style - M2



# OPEN-WEAVE FABRIC BEEKEEPING CLOTHING



**Available sizes:** S - XXXXL

**Fabric:** 100% cotton, net I - polyester 100%, net II - polyester fibre

**Available colors:** white

Increased ventilation thanks to the use of a special spacer fabric

Made of high-quality fabrics

Fabric thickness: 240g / m<sup>2</sup>

It has reflective elements

Pockets: one zippered pocket and one with a hook-and-loop closure on the chest, one long side pocket on the right leg, two hip pockets

Sleeves with thumb elastic loops

Zipper at the bottom of each pant leg for easier suit dressing

Detachable hat

**PREMIUM line**



<b>M6030</b>	Beekeeping jacket made of open-weave fabric with a hat veil, size chart
<b>M6031</b>	Premium Line beekeeping suit made of open-weave fabric with a hat veil, size chart
<b>60389</b>	Replacement hat for the jacket (M6030) and suit (M6031) made of open-weave fabric
<b>M60560</b>	Beekeeping suit with a hat made of 3D spacer-fabric, Premium Line, size chart

# BEEKEEPING CLOTHING WITH VENTILATION



**Available sizes:** S - XXXXL

**Fabric:** 65% polyester, 35% cotton

**Available colors:** white (sweatshirt), yellow (coverall)

**PREMIUM line**

Open-weave fabric panel on the chest, shoulders, and upper back

Made of high-quality fabrics

Double-layered fabric at the knees

Elastic cuffs

Elastic leg ends, zipped at the bottom for easy wear

Detachable fencing-style hat

Shipped in a protective bag



ID	NAME
<b>M6060</b>	"Premium Line" beekeeping suit with ventilation, yellow
<b>M6061</b>	"Premium Line" beekeeping jacket with ventilation, white
<b>6060_MASKA</b>	Replacement fencing-style hat for beekeeping suit with ventilation "Premium Line"
<b>6061_MASKA</b>	Replacement fencing-style hat for beekeeping jacket with ventilation "Premium Line"



Size charts on page 251

## BEEKEEPING SUITS

PREMIUM  
line

M6056R

M6056

M6056B

**Available sizes:** XS - XXXXL**Fabric:** 65% polyester, 35% cotton**Available colors:** white, beige, pink

Zippered pockets (1 on the chest with loop-and-hook closure)

Ventilation holes under the arms

Sleeves with thumb elastic loops

Elastic leg ends, zipped at the bottom for easy wear

On the back, there is an additional veil facilitating ventilation

Detachable hat



ID	NAME
M6056	Beekeeping suit "Premium Line" with hat, beige
M6056B	Beekeeping suit "Premium Line" with hat, white
M6056R	Beekeeping suit "Premium Line" with hat, pink
60380.	Replacement hat for overall "Premium", beige
60380B.	Replacement hat for overall "Premium", white
60380R.	Replacement hat for overall "Premium", pink

## BEEKEEPING JACKETS

PREMIUM  
line

M6057B

M6057

M6057R

**Available sizes:** XS - XXXXL**Fabric:** 65% polyester, 35% cotton**Available colors:** white, beige

4 pockets (chest: 1 zippered, 1 hook-and-loop closure)

Ventilation holes under the arms

Sleeves with thumb elastic loops

On the back, there is an additional veil facilitating ventilation

Detachable hat



ID	NAME
M6057	Beekeeping jacket "Premium Line" (zipped) with a hat, beige
M6057B	Beekeeping jacket "Premium Line" (zipped) with a hat, white
M6057R	Beekeeping jacket "Premium Line" (zipped) with a hat, pink
60380.	Replacement hat "Premium", beige
60380B.	Replacement hat "Premium", white
60380R.	Replacement hat "Premium", pink

Size charts  
on page 251

# BEEKEEPING SUIT WITH REFLECTORS AND LINING

**PREMIUM**  
line



**Available sizes:** S - XXXXL

**Fabric:** 100% cotton

**Available colors:** yellow

It has reflective elements

4 pockets (chest: 2 with hook-and-loop closure)

Sleeves with thumb elastic loops

Elastic leg ends, zipped at the bottom for easy wear

Detachable hat

Lining made of breathable fabric used in sportswear



**M6042**

Beekeeping suit with reflective elements and inner lining - "Premium Line"

**60385.**

Replacement hat for Premium suit with reflective elements and inner lining

# BEEKEEPING TROUSERS

**PREMIUM**  
line



**M6040B**

**M6040**

**M6040R**

**Available sizes:** XS - XXXXL

**Fabric:** 65% polyester, 35% cotton

**Available colors:** white, beige

Zipped pockets

Elastic leg ends, zipped at the bottom for easy wear

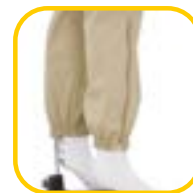

**M6040**

Beekeeping trousers "Premium Line", beige

**M6040B**

Beekeeping trousers "Premium Line", white

**M6040R**

Beekeeping trousers "Premium Line", pink



Size charts  
on page 251

# PROTECTIVE SUIT

## for wasp and hornet nest removal

### (including Asian Hornets)

Designed for professionals involved in the neutralization of wasp, hornet, and Asian hornet nests, this ergonomically tailored protective suit ensures both comfort and maximum protection during high-risk operations.



- **full protection against stings** – the suit offers reliable defense against stings from wasps and hornets, including the highly aggressive Asian hornet (*Vespa velutina*).
- **ergonomic design** – carefully constructed for freedom of movement and extended wear
- **head protection** – equipped with a durable helmet for impact and sting resistance
- **face shield** – integrated visor provides facial protection without compromising safety
- **excellent visibility** – wide field of view allows for precise and safe nest handling
- **complete set** – includes gloves and leg protectors



**STAY SAFE**

**STAY PROTECTED**

**CHOOSE PROFESSIONAL-GRADE GEAR**



**Available sizes:** S - XXXXL

**Fabric:** 250g/m<sup>2</sup> 60% cotton / 40% polyester

Flame-retardant fabric on knees and elbows: 380g/m<sup>2</sup> 100% cotton,  
Quilted lining – 100% polyester

**M6052**

Protective suit for wasp and hornet nest removal  
(including Asian Hornets)



Size charts  
on page 251

# CLOTHING FOR BEEKEEPERS

## CLASSIC LINE

### BEEKEEPING SUITS



M6002B

M6002

**Available sizes:** S - XXXXL

**Fabric:** 65% polyester, 35% cotton

**Available colors:** white, beige

**CLASSIC**  
line

Back of the hat made of veil

Practical, tailored pockets

Elastic cuffs and leg ends

Double support rings in the hat keep the veil at a safe distance from the face

Detachable hat



ID	NAME
M6002	Beekeeping suit "Classic line" with hat, beige
M6002B	Beekeeping suit "Classic line" with hat, white
60320.	Replacement hat for a jacket and suit "Classic Line", beige
60320B.	Replacement hat for jacket and suit "Classic Line", white

### BEEKEEPING JACKETS



M6024B

M6024

M6124

**Available sizes** XS - XXXXL

**Fabric:** 65% polyester, 35% cotton

**Available colors:** white, beige

**CLASSIC**  
line

Back of the hat made of veil

Practical, tailored pockets

Elastic cuffs ends

Double support rings in the hat keep the veil at a safe distance from the face

Detachable hat



ID	NAME
M6024	Beekeeping jacket "Classic line" with hat, beige
M6024B	Beekeeping jacket "Classic line" with hat, white
M6124	Beekeeping jacket "Classic Line" with a hat with round veil beige
60320.	Replacement hat for jacket and suit "Classic Line", beige
60320B.	Replacement hat for jacket and suit "Classic Line", white
60320_S.	Replacement hat for jacket with round veil "Classic Line", beige



Size charts  
on page 251

# BEEKEEPING SUIT WITH FENCING-STYLE HAT

**CLASSIC**  
line



**Available sizes:** S - XXXXL

**Fabric:** 65% polyester, 35% cotton

**Available colors:** beige, gray

Practical, tailored pockets

Elastic cuffs and leg ends

Support frame to keep the mask away from the face

Detachable fencing-style hat

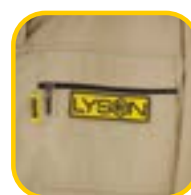

ID	NAME
<b>M60020</b>	Beekeeping suit "Classic line" with fencing-style hat
<b>60330.</b>	Replacement fencing-style hat for suit

# DOUBLE BEEKEEPING SUIT

**CLASSIC**  
line



**Available sizes:** S - XXXXL

**Fabric:** fabric I - 100% polyester,

II fabric - 65% polyester, 35% cotton

**Available colors:** white, beige

Back of the hat made of veil

Practical, tailored pockets

Double-layer fabric

Elastic cuffs and leg ends

Double support rings to keep the veil away from the face

Detachable hat



ID	NAME
<b>M6022</b>	Double beekeeping suit "Classic Line" with hat
<b>603200.</b>	Replacement hat for a double suit



Size charts  
on page 251

# BEEKEEPING JACKET CAMO

**CLASSIC**  
line



**Available sizes:** S - XXXXL

**Fabric:** 65% polyester, 35% cotton

**Available colors:** white, beige

Veil on the back of the hat

Practical, tailored pockets

Sleeves with thumb elastic loops

Double support rings in the hat keep the veil at a safe distance from the face

Detachable hat



Size charts on page 251

ID	NAME
<b>M6044</b>	Beekeeping CAMO jacket "Classic Line"
<b>60383.</b>	Replacement hat for the beekeeping CAMO jacket



# BEEKEEPING SUITS WITHOUT HAT

**CLASSIC**  
line



**Available sizes:** S - XXXXL  
**Fabric:** 65% polyester, 35% cotton  
**Available colors:** beige

Protective sponge around the neck  
Practical pockets tailored  
Sleeves with ribbing

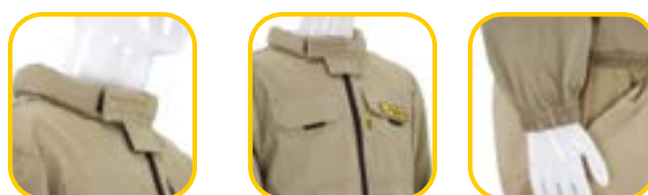

ID	NAME
6003	Beekeeping suit "Classic Line" without hat
6029	Beekeeping jacket "Classic Line" without hat

# BEEKEEPING JACKETS, WITHOUT ZIPPER

**CLASSIC**  
line



**Available sizes:** S - XXXXL  
**Fabric:** 65% polyester, 35% cotton  
**Available colors:** white, beige

Veil on the back of the hat  
Practical, tailored pockets  
Double support rings to keep the veil away from the face



ID	NAME
M6001	Beekeeping jacket "Classic line" with hat, without a zipper, beige
M6001B	Beekeeping jacket "Classic line" with hat, without a zipper, white
60382.	Replacement hat for a jacket without zipper, beige
60382B	Replacement hat for a jacket without zipper, white

# BEEKEEPING JACKET MADE OF THIN, BREATHABLE FABRIC

**CLASSIC**  
line



**Available sizes:** S - XXXXL

**Fabric:** brathable, 65% cotton, 35% polyester

**Available colors:** white

The material from which the jacket is made is thin and breathable, which works well during thin and breathable

Practical, tailored pockets

Double support rings to keep the veil away from the face

Veil on the back of the hat



ID	NAME
M6048	Beekeeping jacket made of thin, breathable fabric, without zipper

# BEEKEEPING TROUSERS

**CLASSIC**  
line



6005

6005B

**Available sizes:** S - XXXXL

**Fabric:** 65% polyester, 35% cotton

**Available colors:** white, beige

Practical, tailored pockets

Elastic leg ends



ID	NAME
6005	Beekeeping trousers "Classic Line", beige
6005B	Beekeeping pants "Classic Line", white



Size charts  
on page 251

# CLOTHING FOR BEEKEEPERS

## OPTIMA LINE

### BEEKEEPING SUIT



**Available sizes:** S - XXXXL

**Fabric:** 65% polyester, 35% cotton

**Available colors:** depending on material's batch

**OPTIMA**  
line

Canvas on the back of the hat

Practical, tailored pockets

Elastic cuffs and leg ends

Detachable hat

Double support rings to keep the veil away from the face



ID	NAME
M6059	Beekeeping suit "Optima line" with hat, beige
60381.	Replacement hat for "Optima line" suit

### BEEKEEPING JACKET



**Available sizes:** S - XXXXL

**Fabric:** 65% polyester, 35% cotton

**Available colors:** depending on the material's batch

**OPTIMA**  
line

Canvas on the back of the hat

Practical, tailored pockets

Elastic sleeve cuffs

Detachable hat

Double support rings to keep the veil away from the face



ID	NAME
M6058	Beekeeping jacket "Optima line" with hat, beige
60381.	Replacement hat for "Optima Line " jacket



Size charts  
on page 251

# CHILDREN'S BEEKEEPING SUITS



COLOR  
line



**Available sizes:** 116, 128, 146, 152, 158 cm

**Fabric:** 65% polyester, 35% cotton

**Available colors:** salmon, blue, turquoise, purple  
Canvas on the back of the hat

Practical pockets

Elastic cuffs and leg ends

Detachable hat

Double support rings to keep the veil away from the face

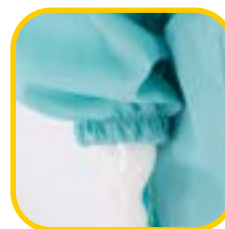

ID	NAME
M6013L	Kids beekeeping suit with hat - salmon
M6013N	Kids beekeeping suit with hat - blue
M6013T	Kids beekeeping suit with hat - turquoise
M6013F	Kids beekeeping suit with hat - purple



Size charts  
on page 251

# CHILDREN'S BEEKEEPING SUITS



**Available sizes:** 116, 128, 146, 152, 158 cm  
**Fabric:** 65% polyester, 35% cotton  
**Available colors:** white, pink, camo

- Canvas on the back of the hat
- Practical pockets
- Elastic cuffs and leg ends
- Detachable hat
- Double support rings to keep the veil away from the face



ID	NAME
M6010	Children's suit with hat, white
M6011	Children's suit with hat, pink
M6012	Children's suit with hat, camo
M6016_R	Replacement hat for children's suit, pink
60384	Replacement hat for children's jacket and suit, white
60321	Replacement hat for children's suit, camo

# CHILDREN'S BEEKEEPING JACKET AND TROUSERS

**Available sizes:** 116, 128, 146, 152, 158 cm  
**Fabric:** 65% polyester, 35% cotton  
**Available colors:** white

- Canvas on the back of the hat
- Practical pockets
- Sleeves and legs with welt
- Detachable hat
- Double support rings to keep the veil away from the face



ID	NAME
M6008	Children's jacket with hat, white - size chart [P]
M6009	Children's trousers, white - size chart [U]

# CHILDREN'S BEEKEEPING HAT



ID	NAME
6016.	Children's beekeeping hat - bees
60160	Children's beekeeping hat - dinosaurs
60161	Children's beekeeping hat - wizards
60162	Children's beekeeping hat - mice
60163	Children's beekeeping hat - football
60164	Children's beekeeping hat - ballerinas

## BEEKEEPING COTTON HATS WITH VEIL



Available colors:



Available colors:



ID	NAME
6025.	Cotton beekeeping hat, veil on the back
602500.	Cotton beekeeping hat with veil and tightening string

## BEEKEEPING COTTON HATS WITH LINEN



Available colors:



Available colors:



ID	NAME
6032.	Cotton beekeeping hat with canvas on the back
60250.	Cotton beekeeping hat with canvas on the back and removable veil

## BEEKEEPING HATS



Available colors:



Available color:



ID	NAME
6066.	Beekeeping hat with elastic bands
60060	Beekeeper hat tied at the front

## BEEKEEPING HATS WITH ELASTIC BANDS



Available colors:



ID	NAME
6006.	Beekeeping hat with elastic bands - white
6006Z	Beekeeping hat with elastic bands - yellow
6006Z1	Beekeeping hat with elastic bands - green
6006B	Beekeeping hat with elastic bands - beige

## LINEN BEEKEEPING HATS



ID	NAME
6033.	Linen beekeeping hat, canvas on the back
6007.	Linen beekeeping hat, veil on the back

## BEEKEEPING HATS CAMO



ID	NAME
6039.	Beekeeping hat, camo, canvas on the back
6038.	Beekeeping camo hat, veil on the back

# NEW T-SHIRTS!

**GearUp**  
with style!

Lots of designs to choose from



NAME
Women's or Men's T-shirt – various designs

## PROTECTIVE VEILS, PROTECTIVE PADS FOR BEEKEEPING

6040Z



6040



6026



6013



Beekeeping hats with a plastic hoop can be machine-washed, preferably inside a protective laundry bag. Whereas, machine-washing hats with a metal hoop may damage both the hat and the washing machine.

## APRONS FOR BEEKEEPING

size	6020			
	height	waist	chest size	aprons length
S	164	64 - 110	122	57
M	170	68 - 128	132	60
L	176	74 - 138	140	62
XL	182	80 - 146	150	64
XXL	188	86 - 152	158	66
XXXL	192	88 - 156	160	68
XXXXL	198	96 - 164	170	70



ID	NAME
6020	White beekeeper's apron, short (S-XXXL)

## GLOVES FOR CHILDREN



ID	NAME
6013.	Beekeeping head veil
6026.	Net for straw hat
6085	Camo baseball cap
6016R	Beekeeping mask
6040	Veil for hat washing with yellow zip
6040Z	Veil for hat washing with green zip

ID	NAME
6011_D6	Gloves for 6-years old children
6011_D9	Gloves for 9-years old children
6011_D12	Gloves for 12-years old children

# LONG LEATHER GLOVES



ID	NAME
60110	Leather gloves, white (S-XXL)
60112	Leather gloves with wide elastic cuff (S-XXL)
60116	Ladies leather gloves, pink (XXS-L)
60113	Leather gloves with hardened wrist, yellow (S-XXL)
60114	Leather gloves, ventilated, yellow (S-XXL)
60111	Leather gloves, yellow (S-XXL)
6011	Leather gloves, sizes: 8-12
6011_R	Leather gloves pink, sizes: 8-11



# LEATHER GLOVES SHORT/PADS



ID	NAME
60115	Leather gloves, short cuff, white (S-XXL)
6049	Leather gloves with cuff 9, 10
6037	Leg protector with rubber
6036	Forearm protector with rubber

# RUBBER/CANVAS GLOVES



ID	NAME
6027	Rubber coated gloves with long cuff: 9, 10
6034	Rubber coated gloves with short cuff
60270	Rubber gloves, acid-proof
6012	Canvas gloves

# APIKAND BEE CANDY & SYRUP



## PROTEIN APIKAND

Designed to be used in the spring to stimulate family to grow. Created for the quick regeneration of bees' families, especially those weakened after winter. Contains a balanced mix of ingredients that support the growth of the family bees in periods when natural resources are not sufficient.



**Ingredients:**

Dextrose (D-glucose): 43%, fructose: 34%, water: 19%, sucrose: 15%, other sugars: 8%, vitamins B1, B2, B6, B12, PP, C, A, D3, E, amino acids, minerals, vegetable fats, antioxidants, essential oils 20%, crude protein 10.5%; water 19%

ID	NAME
3245	Protein Apikand - 1 kg candy

## APIKAND BEE CANDY

- **APIKAND** – stimulates development and strengthens the immunity of bee colonies.
- **APIKAND WITH NOZEVIT** (2.5 ml/kg) – Nozevit is a natural product that supports intestinal health and vitality of bees.
- **APIKAND WITH VITAMINS** – contains vitamins A, B1, B6, B12, C, E, and folic acid.
- **APIKAND WITH POLLEN** – bee candy with added pollen supports bee development during forage shortages (early spring, bad weather). Pollen content: 80 g per 1 kg.

**INGREDIENTS:**

DEXTROSE .....54%  
 FRUCTOSE.....40%  
 TRIOSE .....3%  
 MALTOSE .....2%

3247	Apikand bee candy - 1 kg candy
3246	Apikand bee candy with nozevit - 1 kg candy
3244	Apikand bee candy with pollen - 1 kg candy
3243	Apikand bee candy with vitamins - 1 kg candy

## SUPER PROTEIN APIKAND

**Application:**

- in periods with no fertility, with low-quality pollen or homogeneous fruits;
- for reconstruction after winter, in a period of intensive growth and preparation for production and pollination;
- during creating splits and in bee- families about to be divided;
- in the period of preparation for winter;
- during raising mothers and drones.



**Ingredients:**

fructose 25%, dextrose 18%, beet sucrose 33%, pollen substitute 24.5%, fats, oils (lemon-grass, mint, thyme, basil, chamomile, calendula, lavender, cinnamon, cloves, sage, aloe, lemon balm, St. John's wort, bay leaf, artichoke), vitamins (A, D, E, D3, B2, B3, B12, K, C), citric acid / lactic acid, minerals (Mg, S, Cu, Fe, Zn, Na, Ca, Mn, Co, P), probiotic bacteria, herbal polyphenol extracts, 10% water.

ID	NAME
32350	Apikand Super Protein Candy - 0,45 kg



## APIKAND GRAIN SYRUP

Apikand is a syrup intended to replenish food supplies with a balanced content of essential micronutrients in bee nutrition.

Serving: Apply 0.5 to 1 kg per one bee colony, undiluted.

Shelf life: 12 months

## APIKAND GRAIN SYRUP WITH HERBS

Apikand with herbs is a syrup intended to replenish food supplies, enriched with herbal extracts that help strengthen bee colonies affected by *Nosema apis* and *Nosema ceranae* infections.

Dosage: Apply 0.5 to 1 kg per bee colony, undiluted.

Shelf life: 12 months.



<b>30215</b>	Apikand grain syrup 13 kg
<b>30219_30215</b>	Apikand grain IBC tank - 1400 kg - product for individual order
<b>30216</b>	Apikand grain syrup with herbs 13 kg
<b>30219_30216</b>	Apikand grain with herbs IBC tank - 1400 kg - product for individual order

## APIKAND PREMIUM SYRUP

Bee syrup is best for late winter feeding. As a product free of impurities and easily digestible works as a wholesome, alternative food for the bees. Bees quickly eat and use it in life processes.

Ingredients:

Fructose 40%, Glucose 30%, Sucrose 30%, Water



ID	NAME
<b>3229</b>	Apikand Premium syrup - PET container 7 kg
<b>30217</b>	Apikand Premium syrup - bucket 14 kg
<b>3218</b>	Apikand Premium syrup, bucket - 25 kg
-	Apikand Premium IBC tank - 1300 kg - product for individual order
<b>3319</b>	Apikand Premium Herbal syrup - PET container 7 kg
<b>3317</b>	Apikand Premium Herbal syrup - bucket 14 kg
<b>3318</b>	Apikand Premium Herbal syrup, bucket - 25 kg
-	Apikand Premium Herbal IBC tank - 1300 kg - product for individual order

# 10. SILICONE MOLDS AND CANDLE MAKING ACCESSORIES



Just scan the QR code and see the full catalogue of silicone molds





# CHRISTMAS



**F020**  
Angel with Violin



**FS18**  
Christmas Tree, decorated, small



**FS03**  
Cylinder with Snowflake



**FS435**  
Hanger - Kneeling angel



**FS10**  
Modern Angel



**FS04**  
Ball with Snowflake



**F110**  
Christmas Tree with Crib



**FS06**  
Fairy Ball



**FS411**  
Angel with a snowflake



**FS412**  
Angel with a snowflake on the heart



**FS424**  
Snowman in a hat



**FS05**  
Fairytale Christmas tree



**FS562**  
Candle with stars



**FS518**  
Ball with spruces



**F008**  
Christmas tree, smooth



**FS520**  
Candle with an angel



**F031**  
Easter Egg



**F024**  
Egg with Flowers



**FS163**  
Egg with Lavender



**FS69**  
Egg with Pattern



**FS77**  
Moorhen



**FS74**  
Chicklet in Egg



**F107**  
Little Hare, sitting



**F035**  
Two little Hares



**FS584**  
Lamb, small



**FS587**  
Henry the Hare



**FS586**  
Hen, small



**FS588**  
Openwork Easter egg



**FS579**  
Ribbed Easter egg, large



**FS580**  
Ribbed Easter egg, small



**FS581**  
Easter garland



**FS582**  
Easter bunny in the egg, large



**F017**  
Candle with Honeycomb, small



**F016**  
Skep, small



**F114**  
Beehive



**FS464**  
Bee on the honeycomb



**F007**  
Cube



**FS51**  
Bee's Cylinder



**FS205**  
Beehive small



**FS467**  
Ball with honeycomb



**FS510**  
BEES WAX bar, 0.5 kg



**FS512**  
Tealight bee cell



**FS513**  
Cell with bees



**FS514**  
Honeycomb lump



**FS547**  
A bear with a straw skep



**FS516**  
Honeycomb cube



**FS548**  
Honey gnome



**FS448**  
Cylinder, hearts of wax sheets



**FS60**  
Ball, casted



**FS36**  
Crimson Rose



**FS43**  
Rose Heart



**FS439**  
Roller with heart



**FS410**  
Small Hedgehog



**FS112**  
Little Owl



**FS02**  
Cone, medium



**FS09**  
Cylinder, engraved



**FS558**  
Smiling frog



**FS538**  
Pumpkin



**FS539**  
Pumpkin, oblong



**FS540**  
Rose flower



**FS533**  
HOME cylinder, large



**FS534**  
Duck



**FS521**  
Bouquet of roses



**FS569**  
Heart with an inscription



**FS576**  
Straight cylinder



**FS49**  
Cube, small



**FS54**  
Post, smooth, slim  $\varnothing 65$



**FS403**  
Blessed candle 40x300mm



**FS571**  
Pentagonal pyramid



**FS55**  
Post, smooth, slim  $\varnothing 45$



**FS578**  
Altar candle



**FS577**  
Cake candle



**FS152**  
Cube, high



**FS153**  
Cube, low



**FS50**  
Small pyramid



**FS59**  
Smooth cylinder phi 65, small



**FS415**  
Round candle, small



**FS570**  
Triangular pyramid



**FS417**  
Straight candle, long



**FS34**  
Straight candle, small



# FIGURINES



**FS596**  
Pawn



**FS594**  
Knight



**FS430**  
Bethlehem Nativity scene



**FS480**  
Picture of Mary with the child



**FS592**  
Queen



**FS591**  
King



**FS14**  
Holy Family Figurine



**F145**  
Our Lady with Baby Jesus



**FS595**  
Rook



**FS593**  
Bishop



**FS539**  
Christmas tree with nativity scene



**F110**  
Christmas tree with nativity scene

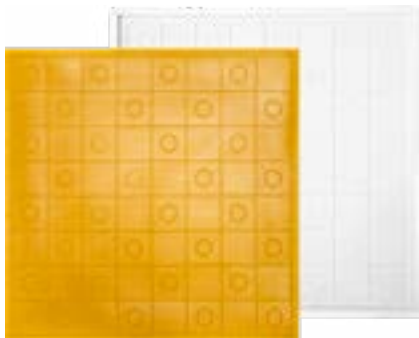

**FS597**  
Chessboard



**FS565**  
Our Lady, figurine



**FS606**  
Jesus figurine

## CANDLE WICKS

ID	NAME
3006	Candle wick 3mm, skein 20m
3112	Candle wick 2mm, skein 20mm
3007	Candle wick 1,5mm, skein 20m
3274	Candle wick 3×13, 20m
3275	Candle wick 3×6, 20m
3276	Candle wick 3×7, 20m
3277	Candle wick 3×8, 20 m
3278	Candle wick 3×9, 20 m
3281	Candle wick 3×16, 20m
3282	Candle wick 3×10, 20m
3283	Candle wick 3×11, 20m
3284	Candle wick 3×18, 20m

### We have two types of wicks:

Round cotton wicks with a thickness of 1.5, 2 and 3 mm flat cotton wicks with a braid weave (the number indicates the number of threads)

The label of the mold contains the suggested wick for the beeswax candle. The selection of the right wick depends on the base material, i.e. the quality of the wax, the type of paraffin etc. The burning of the candle is also influenced by the dyes and fragrances used.



## OTHER ACCESSORIES FOR CANDLE MAKING

ID	NAME
GR01	Rubber bands for slit silicone molds 40x3, 20 pcs
GR02	Rubber bands for slit silicone molds 60x3, 20 pcs
GR03	Rubber bands for slit silicone molds 80x6, 10 pcs
GR04	Rubber bands for slit silicone molds 90x9, 10 pcs
3289	Wick pulling tool 45cm
3288	Wick pulling tool 30cm
3287	Wick pulling tool 20cm
32890	Wick holder, 10 pcs.



## DYES

The amount of dye depends on the desired color intensity – on average, 1 teaspoon per 2.5 kg of wax.



ID	NAME
BR01-FIOLETOWY	Violet pigment 25g
BR02-ROZOWY	Pink pigment 25g
BR05-ZIELONY	Green pigment 25g
BR08-POMARANCZOWY	Orange pigment 25g
BR16-CZERWONY	Red pigment 25g
BR33-BLEKIT	Azure pigment 25g
BR11	Dark yellow candle dye, 25 g
BR04	Yellow candle dye, 25 g
BR31	Black candle dye, 25 g
BR13	Brown candle dye, 25 g

## FRAGRANCES

The recommended ratio is 1 ml per 1 kg of wax. The exact amount depends on the intended fragrance strength. (Fragrance bottle capacity: 35 ml)



ID	NAME
Z800	Fragrance – orange 25 g
Z801	Fragrance – rose 25g
Z802	Fragrance – pine 25g
Z803	Fragrance – green apple 25g
Z804	Fragrance – cinnamon 25g
Z805	Fragrance – lavender 25g
Z806	Fragrance – honey 25 g
Z807	Fragrance – citronella 25 g
Z826	Fragrance – vanilla & coconut 25g
Z832	Fragrance – lemon 25g

# OTHER ACCESSORIES FOR CANDLE MAKING



T834



2015



2014



H12104



H12101

ID	NAME
2014	Stand for silicon mold
2015	Stand for the silicone mold - round
H12101	Pure beeswax pastilles for candle making, 200 g
SILIK01	Silicon spray
T834	Set for tealights (30 pcs)

## TEALIGHT CANDLE MOLD

These soft plastic candle molds are ideal even for craft beginners thanks to their great ease of use. The heart-shaped mold for 8 tealight candles is very resistant to high temperatures, so you can pour melted wax into it without any worries.

At the bottom of each cell of the mold is a cavity in which you can place a special wick with a tealight tin. Simply place the wick in the mold, pour in the wax and wait until the wax solidifies. Our molds are very flexible so that you can pull out the candle after it has solidified without any problem.

Molds dimensions: 22,5 cm x 16 cm

ID	NAME
FM021	Candle molds tealight - hexagons
FM022	Candle molds tealight - stars
FM023	Candle molds tealight - hearts
FM024	Candle molds tealight - rings



FM021



FM022

## WAXED WICK WITH TIN FOR TEALIGHTS

ID	NAME
836	Wick for tealight candle, h-25 mm 3x10 - pack. 100 pcs
837	Wick for tealight candle, h-25 mm 3x13 - pack. 100 pcs



FM023



FM024

# 11. BEE & LOVE

*with love for bees*

**BEE & LOVE** BY LYSON IS A JEWELRY COLLECTION INSPIRED BY NATURE AND A BEE MOTIVE. THE COLLECTION REMINDS US OF THE WONDERFULNESS OF THE WORLD OF BEES AND OTHER POLLINATORS. SILVER NECKLACES, EARRINGS, RINGS AND BROOCHES ARE CHARACTERIZED BY UNFORCED ELEGANCE. IT'S THE PERFECT GIFT FOR A WOMAN WHO LIVES IN HARMONY WITH NATURE. LET THE BEES TO PUT SOME GLAMOUR TO YOUR STYLE.



**SILVER MEDAL**  
APIMONDIA 2022

BEE ON THE HEXAGON EARRINGS



GOLD-PLATED  
SILVER  
BL\_K07

SILVER  
BL\_K08

BEE ON THE HEXAGON BROOCH



GOLD-PLATED  
SILVER  
BL\_W01

HEXAGONS NECKLACE



GOLD-PLATED  
SILVER  
BL\_N10

SILVER  
BL\_N11

NECKLACE WITH PENDANTS WITH BEES ON THE HEXAGON



GOLD-PLATED SILVER  
BL\_N06

BEE ON THE HEXAGON NECKLACE WITH PENDANT



GOLD-PLATED SILVER  
BL\_N08

HEXAGONS BRACELET



GOLD-PLATED SILVER  
BL\_B24

SILVER  
BL\_B25

BEE ON THE HEXAGON BRACELET WITH PENDANTS



GOLD-PLATED SILVER  
BL\_B26

BRACELET WITH BEE ON THE HEXAGON



GOLD-PLATED SILVER,  
NAVY STRING  
BL\_B28

GOLD-PLATED SILVER,  
RED STRING  
BL\_B29

GOLD-PLATED SILVER,  
GREEN STRING  
BL\_B30

GOLD-PLATED SILVER,  
GOLD STRING  
BL\_B31



## CREATIVE BOX - CREATE YOUR OWN SOAPS WITH THE ADDITION OF BEE PRODUCTS

With BEE&SOAP you can take care of yourself using the gifts of nature. Thanks to its unique forms you can create your own original compositions of bee soaps. Their beautiful scent and pro-health effects will help you relax and care for your skin. We will take you to a meadow of flowers and to the sweet world of pollinators.

With us you can fully open up to nature and healthy products.

Welcome to the world of bee and natural BEE & SOAP LYSON and Honey Therapy products. We have currently expanded our offer with an innovative hand-made creative set. Thanks to it, you gain the opportunity to create your own compositions of bee soaps, based on glycerin, floral, aromatic dried, as well as delicate cosmetic additives. The main advantage of a creative box is the fact that a special mold for making soaps can be used many times. You can of course diversify the compositions with your own solutions; regarding the aroma or color of the final product. In the preparation of soaps, you will additionally use honey and beeswax. Due to the high content of vitamins, amino acids, esters and organic acids, these ingredients are a real nutritional bomb for human skin. The glycerin base will provide you with support in the case of epidermis reconstruction.



Set includes:

- special, reusable form
- glycerin soap base
- natural honey
- beeswax
- essential oil
- dried flowers
- decorative semi-parchment paper
- decorative eco twine
- wooden spatula facilitating the composition of ingredients
- instructions



**1**  
Measure the amount of the base and place it in the dish.



**2**  
Place the dish on boiling water and mix the ingredients.



**3**  
Pour the liquid into molds and let it cool.

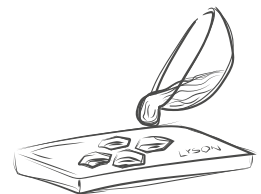

ID	NAME
FMZ01	Creative box – Bee&Soap – Hexagons
FMZ02	Creative box – Bee&Soap – flowers
FMZ03	Creative box – Bee&Soap – Smileys
FMZ04	Creative box – Bee&Soap – Small hexagons

# CREATIVE CANDLE MAKING KIT



**ZKS02**  
Creative candle making kit - Lavender

Create aromatic lavender candles that will fill your home with a relaxing scent. The perfect set for lovers of handicrafts and natural aromas.



**ZKS03**  
Creative candle making kit - Christmas

Feel the magic of Christmas with cinnamon-scented candles and unique shapes. A creative DIY kit perfect for winter evenings and handmade gifts.



**ZKS04**  
Creative candle making kit - romantic

Bring a romantic mood into your home with homemade candles. The sensual scent of rose and delicate forms will add charm to any interior.



**ZKS05**  
Creative kit for making candles - bee motif

Handmade candles in bee style - smelling of honey, in warm colors and charming forms. Perfect for nature lovers.



**ZKS01**  
Creative kit with wax foundation - Natural

Create natural candles from fragrant beeswax foundation without the need to melt the wax. Perfect for the whole family - simple, eco-friendly and creative.



**ZKS06**  
Creative kit with wax foundation - Colorful

Create unique, colorful beeswax candles without melting the wax! A set with molds will allow you to make not only candles, but also decorative pendants.

ID	NAME
<b>ZKS02</b>	Creative candle making kit - Lavender
<b>ZKS03</b>	Creative candle making kit - Christmas
<b>ZKS04</b>	Creative candle making kit - Lavender
<b>ZKS05</b>	Creative candle making kit - Bee theme
<b>ZKS01</b>	Creative kit with wax foundation - Natural
<b>ZKS06</b>	Creative kit with wax foundation - Colorful

## SOAP BASES



ID	NAME
BM01	Soap base - shea butter 0,5 kg
BM02	Soap base - white 0,5 kg
BM03	Soap base - transparent 0,5 kg
BM04	Soap base - goat's milk 0,5 kg
BM05	Soap base - caramel 0,5 kg
BM13	Soap base - jojoba oil 0,5kg
BM14	Soap base - macadamia oil 0,5kg
BM15	Soap base - cocoa butter 0,5kg
BM16	Soap base - avocado 0,5kg
BM17	Soap base - active carbon 0,5kg

ID	NAME
BM011	Soap base - shea butter 1 kg
BM012	Soap base - white 1 kg
BM013	Soap base - transparent 1 kg
BM014	Soap base - goat's milk 1 kg
BM015	Soap base - caramel 1 kg
BM016	Soap base - jojoba oil 1 kg
BM017	Soap base - macadamia oil 1 kg
BM018	Soap base - cocoa butter 1 kg
BM019	Soap base - avocado 1 kg
BM020	Soap base - active carbon 1 kg

## SOAP PIGMENTS

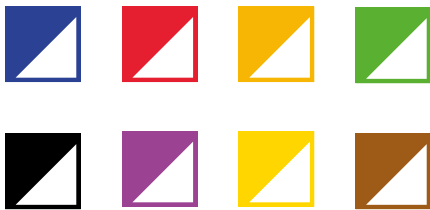

ID	NAME
BM07	Soap pigment red 10ml
BM08	Soap pigment green 10ml
BM09	Soap pigment blue 10ml
BM10	Soap pigment purple 10ml
BM11	Soap pigment orange 10ml

## MIGRATING PIGMENTS

ID	NAME
BM37	Migrating pigment 10ml - brown
BM36	Migrating pigment 10ml - black
BM35	Migrating pigment 10ml - pink

## NON-MIGRATING PIGMENTS

ID	NAME
BM45	Non-migrating pigment 10ml - brown
BM44	Non-migrating pigment 10ml - black
BM43	Non-migrating pigment 10ml - violet
BM42	Non-migrating pigment 10ml - orange
BM41	Non-migrating pigment 10ml - blue
BM40	Non-migrating pigment 10ml - green
BM39	Non-migrating pigment 10ml - yellow
BM38	Non-migrating pigment 10ml - red

## ESSENTIAL OILS



ID	NAME
BM34	Pine essential oil 10 ml
BM33	Orange essential oil 10 ml
BM32	Eucalyptus essential oil 10 ml
BM31	Cedarwood essential oil 10 ml
BM30	Lemon essential oil 10 ml

## FRAGRANCE OILS

ID	NAME
BM29	Fragrance oil for soap 10 ml - marine
BM28	Fragrance oil for soap 10 ml - coffee
BM27	Fragrance oil for soap 10 ml - honey
BM26	Fragrance oil for soap 10 ml - vanilla
BM25	Fragrance oil for soap 10 ml - mint
BM24	Fragrance oil for soap 10 ml - rose
BM23	Fragrance oil for soap 10 ml - jasmine
BM22	Fragrance oil for soap 10 ml - strawberry
BM21	Fragrance oil for soap 10 ml - mango
BM20	Fragrance oil for soap 10 ml - chocolate
BM19	Fragrance oil for soap 10 ml - coconut
BM18	Fragrance oil for soap 10 ml - cinnamon

# SOAP MOLDS

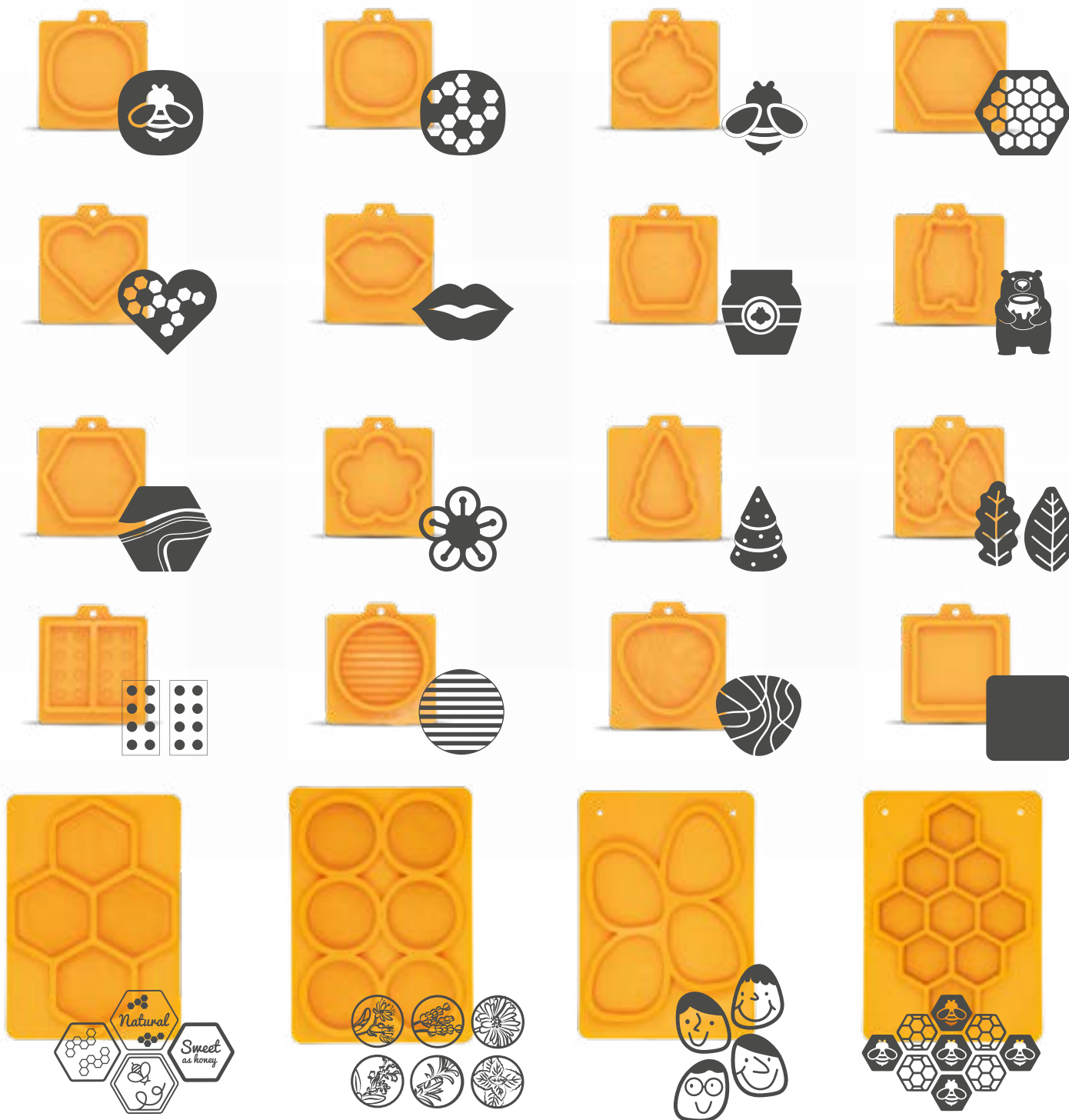

ID	NAME
FM001	Soap molds - bee (oval shaped)
FM002	Soap molds - hexagon (oval shaped)
FM003	Soap molds - bee
FM004	Soap molds - hexagon
FM005	Soap molds - heart
FM006	Soap molds - lips
FM007	Soap molds - honey jar
FM008	Soap molds - bear
FM009	Soap molds - expression
FM010	Soap molds - flower

FM011	Soap molds - Christmas tree
FM012	Soap molds - 4 soaps, hexagons
FM013	Soap molds - 6 soaps, flowers
FM014	Soap molds - 4 soaps, smiley faces
FM015	Soap molds - 3 soaps, small hexagons
FM016	Soap molds - leaves
FM017	Soap molds - Lego bricks
FM018	Soap molds - round with stripes
FM019	Soap molds - triangle
FM020	Soap molds - smooth square

# Pasieka

## PASIEKA OFFER



Choose  
your favorite  
labels,  
PCV boards,  
or banners  
from the catalog,  
and we'll  
translate  
them for you.

1

Check out our catalog  
with the full offer



Make your choice and  
let's connect

2

We'll translate your  
request

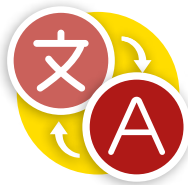

and create your chosen  
labels, banners, or  
boards

3

Stand out in your  
country



with our products

Ask for details: [contact@pasieka24.pl](mailto:contact@pasieka24.pl)

# LABELS

Prepare your own text

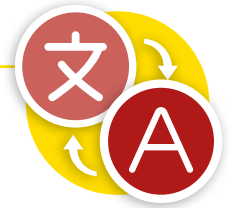

More than **500** designs

We customize the labels to your needs

Self-adhesive, packed in pack - **100 pcs**



Ask for details: [contact@pasieka24.pl](mailto:contact@pasieka24.pl)



EEN2001



EEN2022



E270



E306



E215



E333



E430



E41



E1250



E33



E16

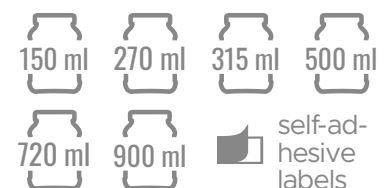

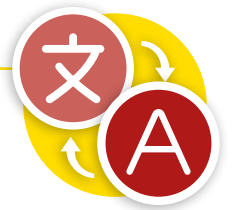

Ask for details: [contact@pasieka24.pl](mailto:contact@pasieka24.pl)



FEN-34



FEN-35

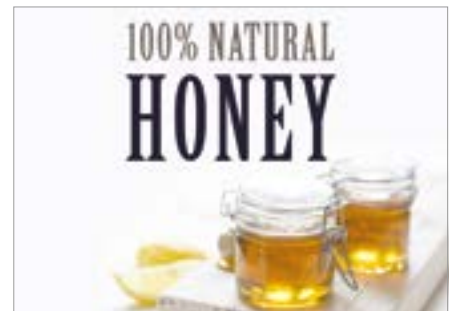

FEN-42



FEN-263



FEN-277



FEN-14



FEN-29

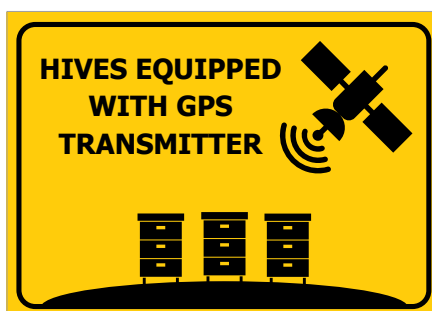

FEN380



FEN-31

# JARS



**A38**  
capacity: 30 ml



**A39**  
capacity: 80 ml



**A40**  
capacity: 150 ml



**A63**  
capacity: 300 ml



**A1**  
capacity: 35 ml



**A13**  
capacity: 120 ml



**A2**  
capacity: 106 ml



**A12**  
capacity: 106 ml



**A82**  
capacity: 900 ml



**A94**  
capacity: 350 ml



**A27**  
capacity: 440 ml



**A28**  
capacity: 720 ml

# JAR LIDS Ø82MM



**ND03**



**ND04**



**ND06**



**ND14**



**ND16**



**ND18**



**ND25**



**ND32**



**ND35**



**ND36**



**ND67**



**ND68**



**ND73**



**ND81**



**ND64**



**ND65**



**ND86**



**ND98**



**ND99**



**ND121**



**ND123**



**ND118**



**ND119**



**ND120**



**ND84**



**ND108**



**ND109**



**ND110**



**ND114**



**ND115**



**ND117**



**ND116**

# JAR BASKET



TS4



TS1



TS2



TS3

# HONEY JAR BOXES



P23a



P21a



P22a



P1j



P1g



P2g



P17b



P3c

# THERMAL INSULATION OF THE HIVE

## III All-season, bubble thermal insulation mat

- » Maintaining the optimum temperature for brood development throughout the year
- » Increased chances of the colony surviving the winter
- » Improved spring development
- » Protection of the hive against overheating in summer



An insulating mat for the hive is an easy way to keep bees comfortable year-round, promoting better health and higher productivity

## Clasic Bubble



<b>MI1</b>	All-season, bubble thermal insulation mat, mini beehive, 27x27 cm
<b>MI2</b>	All-season, bubble thermal insulation mat, 6-frames 42cmx27cm
<b>MI3</b>	All-season, bubble thermal insulation mat, 6-frames Dadant beehive 42cmx27cm
<b>MI4</b>	All-season, bubble thermal insulation mat, beehive 42cmx42cm
<b>MI5</b>	All-season, bubble thermal insulation mat, beehive 49cmx42cm
<b>MI7</b>	All-season, bubble thermal insulation mat, 40cmx40cm
<b>MI8</b>	All-season, bubble thermal insulation mat, 42cmx50cm
<b>MI6</b>	All-season, bubble thermal insulation mat, roll, 12,5mx0,6m
<b>MI9</b>	All-season, bubble thermal insulation mat, roll, 12,5mx1,2m
<b>MI10</b>	All-season, bubble thermal insulation mat, roll, 12,5mx0,09m

## Double Bubble



<b>MI1P</b>	All-season double-bubble thermal insulation mat for mini beehives, 27 × 27 cm
<b>MI2P</b>	All-season double-bubble thermal insulation mat for, 6-frames 42cmx27cm
<b>MI3P</b>	All-season double-bubble thermal insulation mat for, 6-frames Dadant beehive 49cmx27cm
<b>MI4P</b>	All-season, Double bubble thermal insulation mat, 42cmx42cm
<b>MI5P</b>	All-season, Double bubble thermal insulation mat, beehive 49cmx42cm
<b>MI6P</b>	All-season, Double bubble thermal insulation mat-roll, 12,5mx0,6m
<b>MI7P</b>	All-season, Double bubble thermal insulation mat, 40cmx40cm
<b>MI8P</b>	All-season, Double bubble thermal insulation mat, 42cmx50cm
<b>MI9P</b>	All-season, Double bubble thermal insulation mat, roll, 12,5mx1,2m
<b>MI10P</b>	All-season, Double bubble thermal insulation mat, roll, 12,5mx0,09m

## III Felt mat

- » Reduction of thermal stress
- » Appropriate thermal conditions
- » Proper humidity



- Ready-made formats: 40 × 40 cm, 45x39, 50 × 42 cm
- Full rolls: 40 × 2 000 cm or 50 × 2 000 cm
- Your custom format in any size

**We make custom-made mats in any size**

# AN EDUCATIONAL TRAIL IN YOUR AREA!



This educational trail is an innovative project aimed at local residents, students, tourists and beekeepers. It promotes knowledge about bees, their role in the ecosystem and the importance of sustainable beekeeping. The educational boards combine learning with interactive fun in an attractive way, engaging visitors in discovering the fascinating world of bees.

Durable and aesthetically pleasing educational boards with interactive elements are an eye-catching must-have! Attractive content, illustrations and QR codes with access to a list of local beekeepers support nature education and promote knowledge about the role of bees in the environment.

**The boards are made of durable dibond, and their powder-coated steel construction ensures resistance to weather conditions.**



Possibility of translation into other languages.



Weather-resistant and long-lasting



Present content that is attractive to children and adults



Present content that is attractive to children and adults



Interactive elements develop motor skills



Boards stimulate to further play



Present content that is attractive to children and adults

There are 8 educational board designs to choose from, covering various topics related to bees.

Available in two distinctive designs—rectangular form and hexagonal shape that reflects the natural shape of a honeycomb.

You can choose a single board or create a complete educational trail with 8 boards.

**PATTERN 1: THE DANCE OF THE BEES**

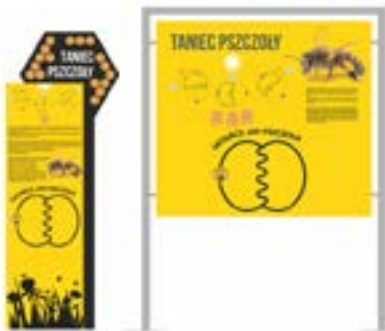

Code: EDU\_SM1

Code: EDU\_SD1

**PATTERN 2: HONEY BEES**



Code: EDU\_SM2

Code: EDU\_SD2

**PATTERN 3: THE BEE FAMILY**



Code: EDU\_SM3

Code: EDU\_SD3

**PATTERN 4: HONEY PRODUCTION**



Code: EDU\_SM4

Code: EDU\_SD4

**PATTERN 5: HONEY PLANTS**



Code: EDU\_SM5

Code: EDU\_SD5

**PATTERN 6: HONEY PLANTS**



Code: EDU\_SM6

Code: EDU\_SD6

**PATTERN 7: BUY LOCAL HONEY**



Code: EDU\_SM7

Code: EDU\_SD7

**PATTERN 8: BEE PRODUCTS**



Code: EDU\_SM8

Code: EDU\_SD8

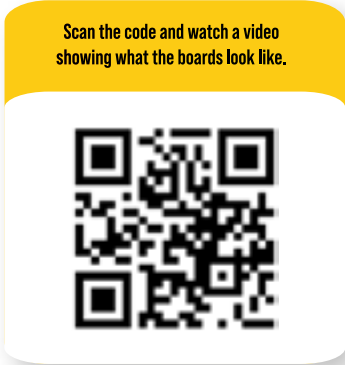

ID	NAME
EDU_SM1/SM8	Information board - hexagon, pattern
EDU_SD1/SD8	Information board - large, pattern 1-8

# THE BEEKEEPER BEAR, THE BEEKEEPING SUIT



**The beekeeper bear** is a cute mascot that will become a perfect companion for any bee lover. Its soft, plush fur makes it ideal for cuddling, and dressing it in a mini beekeeper's outfit gives it a unique and original character.

This collectible, teddy bear is a beautiful decoration and a great way to arouse the interest of the youngest in the fascinating field of beekeeping.

Height: 40 cm



**The beekeeping suit** for the beekeeper bear is a cute miniature replica of a protective beekeeper's outfit that will make any mascot look like a real beekeeper.

The suit is available in four beautiful colours: **salmon, purple, turquoise and blue**. Each colour is carefully selected to emphasize the unique character and style of the teddy bear.

The jumpsuit is the perfect addition to our beekeeping teddy bear, but it can also be used as a decoration for other mascots, thus creating a fun and original arrangement.

It will be perfect as a collector's item, adding charm to any children's room or apiary.



**The elements (teddy bear and overalls) are sold separately.**

Each mini beekeeper outfit is carefully packaged in an elegant, transparent zipper packaging that protects it from dirt and makes it gift-ready.



ID	NAME
M6063M	The beekeeper bear
M6063F	Mini beekeeper suit - purple
M6063L	Mini beekeeper suit- salmon
M6063N	Mini beekeeper suit - blue
M6063T	Mini beekeeper suit- turquoise

# BEES SKILL GAME

This bee-themed game of skill is an activity that develops coordination, reflexes and motor skills. The game involves throwing bags into wooden compartments that imitate cells in a honeycomb.

Dimensions: 115 cm x 115 cm x 12 cm



The perfect attraction for family picnics



Promotes physical activity



ID	NAME
API303	Bees skill game

# LARGE-FORMAT GAME

This educational game transports players into the world of bees on an XXL scale! The large board, colourful graphics and dice attract attention and encourage everyone to play together. In this version of the game, there is no need for pawns – players move along the path on the board, learning the secrets of bee life.

The game teaches how a bee family functions, what the duties of workers, drones and the queen are, and why bees are so important to the environment. Great for picnics, school events and family festivals.

Size: 350 cm x 490 cm

ID	NAME
API302	Large-format bee game



Possibility of translation into other languages.



# GIANT SMOKER

This impressive zoomed-in replica of a smoker is not only a giant version of a traditional beekeeping smoker, but also an effective educational and scenographic prop. Perfect for festivals, themed picnics and beekeeping events, it attracts the attention of children and adults alike. It can be used as a decoration, part of a display, or an incentive for photos. Solid workmanship and attention to detail make the product impressive in both form and functionality.

The smoker is powered by electricity – 230V. Thanks to the power supply and built-in smoke generator, water vapour is emitted from the device.

ID	NAME
API300	Giant smoker

FOR  
**KIDS**

## BEE BLOCK SETS

Bee-themed building block sets are a perfect choice for young nature explorers. They spark imagination, creativity and develop motor skills.

Kids can build and play out fun scenes straight from a beehive and blooming meadows. It's not just play—it's a fun way to learn about the role of bees in nature!

ID	NAME
API224	Buzzing bee - building blocks set
API225	Bee & bloom - building blocks set
API226	Bee on sunflowers - building blocks set
API227	The queen bee - building blocks set



# SIZE CHARTS FOR BEEKEEPING CLOTHING



Scan to see the full size chart and available sizes



## How to choose the right size of beekeeping clothing?

When choosing beekeeping clothing, it is a good idea to leave some room – the clothing should not be tight-fitting. A looser fit reduces the risk of stings, as the fabric does not directly touch the skin. Measure yourself in the clothing you usually wear when working at the hive, and add about 10–15 cm to the chest and waist measurements. Also check the length of the sleeves and legs – they should be overlapping the gloves and boots to ensure a tight fit.



- A - blouse length
- B - waist
- C - chest size
- D - sleeve length

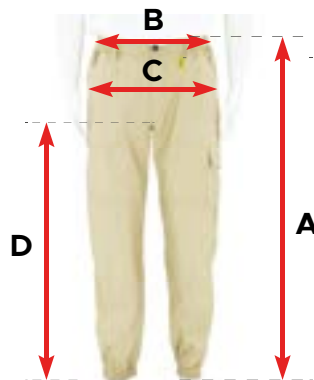

- A - trousers length
- B - waist
- C - hips
- D - inseam length

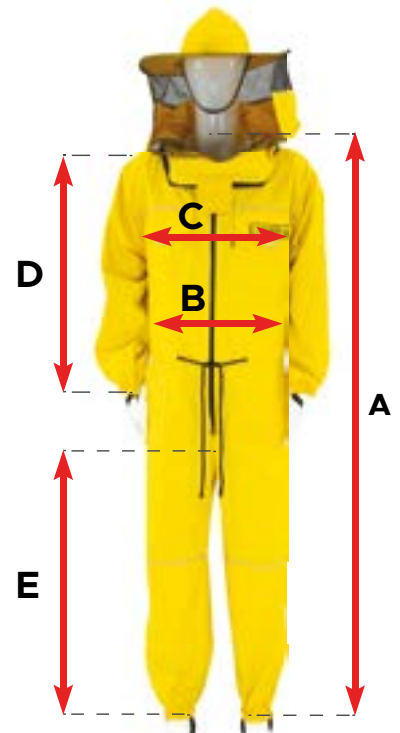

- A - suit length
- B - waist
- C - chest size
- D - sleeve length
- E - leg length

**ARMENIA**

APIS A LLC АПИС А 000  
ул. Айаси 114  
Ереван  
Армения  
Тел. +37441589991  
apisashop@gmail.com

**AUSTRALIA**

Lyson Beekeeping Supplies  
18B Industrial Avenue,  
Mudgee NSW 2850  
tel. +61 1800 955 579  
info@lysonau.com.au  
www.lysonau.com.au

**AUSTRIA**

Imkereibedarf Seiringer  
Vöcklabruckstrasse 14/1,  
4800 Attnang-Puchheim  
tel. +43 660 4414093  
roland@imkerei-seiringer.com  
www.imkerei-seiringer.com

Imkershop Wien  
Peter Kubista  
Rußbergstraße 11/3/R01  
1210 Wien  
tel. +43 699 14075989  
office@imkershop-wien.at  
www.imkershop-wien.at

**BELGIUM**

BEEBOX WORLD SCRL.  
Rue du Trou du Sart 8, 5380 Fernelmont  
(Namur),  
tel. 0032 /81 36 37 38  
info@beeboxworld.com  
www.beeboxworld.com

BIJENHOF BV  
Moravie 30, 8501 Bissegem  
tel. 0032 / 56 35 33 67  
fax: 0032/ 56 37 17 77  
desk@bijenhof.be  
www.bijenhof.be

**BULGARIA**

BEE HOME BG-LTD GORNI BOGROV VIL SOFIA  
Sofia, postcode.1806, 663 Botevgradsko  
Shose Blvd.  
tel. 0878 297 162, 02/ 994 62 66  
www.beehome.bg  
beehome@abv.bg

ACM 53 E00D  
Denimir Minev,  
gen.V.Zaimov 4, Tuchenica Pleven 5800  
tel. +359 88 826 5242  
denimir@hotmail.com

VIMEKS-M 00D  
8800 Sliven, blv. Stefan Karadzha, 42-A  
tel. 044 625486, 0898 435 408;  
vimeks@abv.bg  
www.vimeks-bg.com

**CANADA**

Worker and Hive Bee Supply  
#102 - 4215 72 AVE, SE,  
CALGARY, ALBERTA, T2C 2G5  
tel. (403) 764-8177  
info@workerandhive.com  
www.workerandhive.com

Dancing Bee Equipment  
5029 County Road 2  
Port Hope, ON L1A 3V5  
1-905-753-2623  
www.dancingbeeequipment.com

Dancing Bee Equipment  
31060 PR501 (Rosewood Road)  
Dufresne, MB R5K 0P2  
tel. +1-204-866-2402  
www.dancingbeemanitoba.com

ApiHex  
500 Rue Léger, Riviere-Beaudette, QC J0P 1R0,  
tel. +1 855-666-3233  
huseyin@apihex.com  
www.apihex.ca  
www.apihex.com

**CHILE**

Agro-Apicultura LTDA  
Camino Troncal PARCELA 74, Villa Alemana  
tel. +56 9 76681035  
ventas@apicola.cl  
www.apicola.cl

**CROATIA**

GALA MED ZA PČELARSTVO I TRGOVINU  
Gala 169 A, 21238 Otok (Dalmacija)  
tel. +385 21 839 008  
mob: +385 91 55 88 211  
info@galamed.hr  
www.galamed.hr

AGRO SIMPA D.O.O.  
Novoselska 169B, Novo Selo  
44010 Sisak - Caprag  
tel. +385(44)719-435  
agrosimpa@agrosimpa.hr  
www.agrosimpa.hr

**CYPRUS**

Melissokipos Emporiki  
Spartis 3, 2480 Tseri, Nicosia  
tel. +357 (70)007031  
mob. 99626351  
info@melissokipos.com  
www.melissokipos.com

**CZECH REPUBLIC**

VAST-OIL spol. s.r.o.  
Těreškovové 2347/50, 734 01 Karviná-Mizerov  
tel. +420 596 317 842  
fax. +420 596 312 488  
sciskala@vastoil.cz  
www.vastoil.cz

JaHan s.r.o.  
Jaurisova 515/4,  
14000 Praha 4 - Michle  
tel. +420 737 446 619  
objednavky@vceliobchod.cz  
www.vceliobchod.cz  
www.jahan.cz

Včelí prodejna - Bc. Jaroslav Mauř  
Kostelní 39, 569 43 Jevíčko  
tel. +420 515 535 721  
info@vceliprodejna.cz  
www.vceliprodejna.cz

Včelařství Jindra - Jiří Jindra  
Gen. Svobody 16, 550 01 Broumov 1  
tel. +420 725 726 073  
info@vcelarstvjiindra.cz  
www.vcelarstvjiindra.cz

Marcela Šafařová - Včelařství Ježov  
Ježov 142, 696 48 Ježov,  
tel. +420 731 745 904  
vcelarstvi.jezov@seznam.cz  
www.uvcelky.cz

Roman Frána - včelařské potřeby  
Bucharova 194 (bývalý OPTREX / TESLA), 543  
02 Vrchlábi 4  
tel. +420 605 130 207  
info@vcelka-shop.cz  
www.vcelka-shop.cz

Včelařství Rázovi  
Arbesova 820,  
337 01 Rokycany  
tel. +420 602 683 133  
razova@vcelarstvi-razovi.cz  
www.vcelarstvi-razovi.cz

Včelařství u Kunclů  
Mašovice 125, Děčín, 40502  
tel. +420 777 298 705  
vcelarstviukunclu@seznam.cz  
www.vcelarstviukunclu.cz

**DENMARK**

BIHUSET  
4733 Tappernoje, Rodlersvej 11  
tel. +45 55 96 53 22  
bihuset@bihuset.dk  
www.bihuset.dk

**DENMARK**

Aulum BiavlsCenter  
Buntmagervej 18, 7490 Aulum,  
tel. +45 9641 2100  
info@aulumbi.dk  
pf@aulumbi.dk  
www.aulumbi.dk

**ESTONIA**

SONTRAVENTO OU, INDREK POLLUKS  
Narva tn 31  
44311 Rakvere linn  
tel. +372 53920862  
info@mesinduspood.ee  
www.mesinduspood.ee

Muhe Mesi OÜ  
Nurmelauda,  
Müüriku 46220  
Lääne-Viru maakond  
tel. +372 555 68 732  
e-pood@muhemesi.ee

**FINLAND**

MESIMESTARI OY  
Viraantie 254  
37370 Vesilähti  
mob.: Juha: + 358 400 523 188  
mob.: Katarina: + 358 400 257 007  
mesi@mesi.fi  
www.mesi.fi

**FRANCE**

ICKO Apiculture  
ZAC Sud Drôme Provence - Impasse des Senteurs  
26130 Saint Paul 3 Chateaux  
tel. +33 (0)4 90 40 49 71  
commercial@icko-apiculture.com  
www.icko-apiculture.com

NATURAPI  
13 Rue Saint-Exupéry,  
63800 Courmon-d'Auvergne  
tel. +33 (0) 4 44 44 96 30  
commercial@naturapi.com  
www.naturapi.com

MAISON LEROUGE APICULTURE  
Maison LEROUGE Oise  
7 Route de Coivrel  
60420 MAIGNELAY-MONTIGNY  
tel. 03 44 78 54 88  
api0@lerouge-apiculture.com  
lerouge-apiculture.com

**GEORGIA**

IMPERVET LTD  
142 Akaki Tsereteli Ave, Tbilisi,  
tel. +995 597 588 653  
tel. +995 593 33 07 01  
info@impervet.ge  
impervet@yahoo.com  
www.impervet.ge

**GERMANY**

DUENSING IMKEREIBEDARF  
Waller Str. 22, 29308 Winsen/Aller  
tel. +49 5143-6690966  
fax. +49 5143-669399  
info@duensing-imkereibedarf.de  
www.duensing-imkereibedarf.de

BIENE24.DE  
Hasengärtlestraße 65, 88326 Aulendorf  
tel. +49 7525923177  
hallo@biene24.de  
www.biene24.de

Imkereibedarf Tyroller  
Dorfstraße 1a, 86561 Rettenbach  
tel. +49 8252882994  
info@imkereibedarf-tyroller.de  
www.imkereibedarf-tyroller.de

Imkerei & Imkerfachhandel Wittig  
Gasse 2 OT Rhäsa  
01683 Nossen  
tel. +49 3524270581  
mob. +49 15155654975  
info@sachsenhonig.de  
www.sachsenhonig.de

**GERMANY**

Imkerezentrum Łukasiewicz  
Suchlica 5a, 74-404 Cychry, POLAND  
tel. +48 723 710 100  
biene@imkershop24.de  
www.imkershop24.de

**GREECE**

ARCADIKI MELISSOKOMIA S.A.  
Mandra Attikis, 19600  
tel. +302105551880  
info@arkmel.gr  
www.arkmel.gr

**HUNGARY**

BALTA LASZLO  
Balta és Balta Kft, H-2114 Valkó Ady E u 9  
tel. +36 30 201 2399  
baltakft@baltakft.hu  
www.baltakft.hu

Méhész Centrum Kft.  
Ipari terület 060/31 (Kossuth utca),  
HU-4161 Bátorád  
tel. +36 30 915 9950  
mehezszentrum@gmail.com  
mehezszentrum.hu  
beefonda.hu  
lyson.hu

**IRELAND**

DONEGAL BEES  
Cashel, Glencolmille, Co. Donegal  
Ireland F94KP97  
IE: +353 (0)74 97 10140  
UK: +44 (0)20 3582 3502  
enquiries@donegalbees.ie  
www.donegalbees.ie

**ISRAEL**

Lamdani Ltd.  
Kfar Haim 42945, Khalin  
tel. 972-9-861 75 96  
fax. 972-9-862 38 47  
mob. 972-54-449 61 89  
khagreg@gmail.com

**ITALY**

Consorzio Con Le Api  
Strada Comunale delle Fine, snc, 86073 Colli A  
Vulturmo  
tel. +39 392 661 0758  
info@consorzioconleapi.it  
www.consorzioconleapi.it

Savuto Srl  
c/da Ciota 7 87030 Cleto, CS, IT 01486680786  
tel. +39 0982 44760  
savutoapicoltura@gmail.com  
www.savutoapicoltura.com

HOBBY FARM di Rubatto Riccardo & C. sas  
Via Milano 139, 13900 BIELLA,  
tel. 015 28628  
fax. 015 26045  
info@hobbyfarm.it  
www.hobbyfarm.it

**JAPAN**

Akitaya Honten Co Ltd  
1-18 Kanojonandori Gifu-shi, 500-8486 Gifu  
tel. +81-58-272-1311  
mitsubachi@akitayahonten.co.jp  
www.akitayahonten.co.jp

**JAPAN**

Tawara Apiaries, Ltd.  
3-3-18 Sumiyoshi-Minamimachi  
Higashinada-Ku  
Kobe-shi, Hyogo 658-0041  
tel. +81-78-854-0238  
order@tawara-api.jp  
www.tawara88.com

**KAZAKHSTAN**

ВОШИНА ОТ ЖАННЫ « Владимир Питенко  
г. Алматы, улица Прокофьева, д. 179"Вощина  
от Жанны  
Тел. +7 (727) 268-46-93,  
Тел. +7 (777) 225-38-74  
Тел. +7 (771) 415-53-11  
www.pchelka-zhanna.satu.kz

**KAZAKHSTAN**

Пчеловодческий комплекс "Пасека"  
Республика Казахстан  
Восточно-Казахстанская область, г.Усть-Каменогорск, с.Меновное,  
ул.А.Янушкевича 126  
Тел. +7(7232)525243,  
Тел. +7(7232)517711,  
Тел. +7 7779850098  
paseka-111@mail.ru  
www.paseka-111.kz  
www.lysonkz.com

**KUWAIT**

Almaraseem honey apiaries co. W.I.I  
Yaqoub Yousef Alzaabi  
Alsiddiq  
Block 6 Street 605 House87  
Hawally, Kuwait13126  
tel. +965 66600454  
yaqoub.yousef@outlook.com

**LATVIA**

"VINNIS" Itd.  
Lacu Street 10, Cesis LV 4101  
tel. +371 64122527  
bisubode@vinnis.lv  
www.vinnis.lv

SIA Lauku Apgāds un meliorācija  
Dzīmanu iela 18, Smiltene, Smiltēnes novads,  
LV-4729  
tel. +371 25600574 Bisu Lietas  
bisulietas@lam.lv  
www.bisulietas.lv

**LEBANON**

Est Afif Abi Chedid  
Byblos – Lebanon  
Hosrayel : zone blue street 11-A1,  
Golden Queen center building 61  
tel. +961 3 634563 / +96170321886  
afif@goldenqueencenter.com  
jbalna@hotmail.com

**LITHUANIA**

UAB "WILARA"  
Birutės g. 5, LT-59140 Prienai  
tel. +370 319 60312  
mob. +370 688 48798  
info@wilara.lt  
www.wilara.lt

**LUXEMBOURG**

Beienhaff  
Pierre Kusnierz  
14, Wantergaass L-7670 Reuland  
tel. +352 621 160 639  
info@beienhaff.lu  
www.beienhaff.lu

**MOLDOVA**

Albilux Prod SRL  
str.Independenței 22, MD-2060 Chișinău  
tel. +373 22 76 56 09  
fax. +373 22 76 49 84  
mob. +373 780 83 888  
info@albilux.md  
www.albilux.md

**MOLDOVA**

ECOSTUP SRL  
sos. Hincesti 204  
MD2070 Chisinau  
tel. +37369511229  
tel. +37360414146  
contact@ecostup.md  
www.ecostup.md

**MOROCCO**

SOCIETE RAIS TRADE MOROCCO  
DOUAR SMAALA AIN KKERMA, MEKNES  
tel. +212-(0)-661-61-88-87  
tel. +221 6-61-40-79-74  
societeraistrade@gmail.com

**NETHERLANDS**

Apis International  
Brandenburglaan 8, 4333BZ Middelburg,  
tel. +31(0)622 083 090  
info@imkershop.nl  
www.imkershop.nl

**NEW ZEALAND**

Lyson Beekeeping Supplies  
tel. +64 27 519 7900  
info@lysonnz.co.nz  
www.lysonnz.co.nz

**NIGERIA**

Apicentre Integrated Services Limited  
Michael Eneh  
Block 3, Flat 1 ; Agric Qtrs, Oran Street ; Zone 1,  
Wuse, Abuja  
info@apicentreg.com.  
tel. 07037894702

**NORWAY**

Honningcentralen SA  
Dyrskueveien 20, 2040 Kløfta  
tel. 63942060,  
post@honningcentralen.no  
www.honning.no

**PORTUGAL**

Doureebe Lda  
Sano Joao da Pesqueira, 4860-285, Rua Direita  
Loja 7oA 5130-343  
tel. +351 254-406-185, +351 967-141-861  
geral@doureebe.com  
www.doureebe.com

GoldenBee Bruno Cartaxo  
Rua Bernardino Machado, 96, 3070-432,  
Valeirinha – Mira  
tel. +351 916457534  
goldenbee@sapo.pt  
www.goldenbee.pt

**JGS BEEKEEPING**

Lugar de Parada, Pedraça, 4860-285,  
Cabeceiras de Basto  
tel. + 351 916965477  
comercial@jgsousa.pt  
geral@jgsousa.pt  
www.jgs-apicultura.com

**ROMANIA**

APIS SRL  
Gheorghe Baritiu street, no. 32, Blaj, 515400,  
Alba district, Romania  
tel. 40745-582.990 / +40758-083.784  
apis.blaj@gmail.com  
www.apis-blaj.ro

**REPUBLIC OF SOUTH AFRICA**

BEEWARE  
Hollow Space Creations – BeeWare,  
Coachmans Crescent, Shop #6, 26 Jacaranda  
Street, Hennopspark, Centurion,  
tel. 061 980 6551 | 081 426 4333 | 12 771 4288  
orders@beeware.co.za  
www.beeware.co.za

**SAUDI ARABIA**

Beekeepers Cooperative Association  
PO Box 30, 22888 BALJURASHI, ALBAHA  
aalkhazim@gmail.com  
gamalkhalid1@gmail.com  
www.saudibi.com

**SLOVAKIA**

APIPRODUKT s.r.o.  
J.A. Komenského 68,  
991 06 Želovce  
tel. +421 47 48 93114, +421 47 48 93041  
mob.: 00421 918 079 221  
info@apiprodukt.sk  
www.apiprodukt.eu

**SLOVENIA**

BELOKRANJSKI HRAM, trgovina in storitve d.o.o.  
Ulica Staneta Rozmana 26, 8340 Črnomelj,  
tel. +386 40 745 750, +386 40 748 588  
info.belokranjski-hram@t-2.si  
www.belokranjski-hram.si

**SOUTH KOREA**

Lifeone  
17-33 #231Sannam-ro, Paju-city Kyeonggi-do  
tel. 010-3711-2039  
www.lyson.co.kr

**SPAIN**

Apitienda Soltan S.L.U  
APITIENDA SOLTAN SL, Calle Francisco de Medina  
y Mendoza 45,  
pol ind Cabanillas del Campo, cp19171  
Guadalajara  
tel. +34 949 873 359, +34 640 527 836  
info@apitienda.es  
www.apitienda.es

LA TIENDA DEL APICULTOR  
Calle Casals, 4, 46790 Xeresa (Valencia)  
tel. +34 670 393 011  
info@latiendadelapicultor.com  
www.latiendadelapicultor.com

APÍCOLA LOS PEDROCHES  
Camino Virgen de Luna s/n, 14400 Pozoblanco  
(Córdoba), España (Spain)  
tel. +34 957 116 689; +34 637 302 517  
+34 637 302 517 (WhatsApp)  
info@apicalosalpedroches.com  
www.apicalosalpedroches.com

**SWEDEN**

Joel Svenssons Vaxfabrik AB  
Skälderhus, Klippanv. 905, SE 266 94 Munka  
Ljungby  
tel. +46-431-430055  
fax. +46-431-431855  
info@joelvax.se  
www.joelvax.se

**SWITZERLAND**

Apimedi GmbH  
Bogenstrasse 37, 9621 Oberhelfenschwill  
tel. +41 (0) 71 374 29 65  
fax. +41 (0) 71 374 29 64  
info@apimedi.ch  
www.apimedi.ch

**APIMAT Sàrl**

Les Vernets 4, 2035 Corcelles (NE)  
Tel & Whatsapp : 076 213 80 33  
info@apimat.ch  
www.apimat.ch

**SYRIA**

Paradise Co.  
Syria – Damascus, Midan Cournish, Opposite to  
Bemo Bank  
tel. 00693-11-8845557  
tel. 00963-11-8845558  
Mob: 00963-933224056  
paradise.int@outlook.com

**TANZANIA**

CENTRAL PARK BEES LIMITED  
Off DSM Rd, Swai Street, House no. 40 Makole  
P.O. BOX 4105  
Dodoma, Tanzania  
tel. +255 753 196849  
tel. +255 689 658811  
joseph@centralparkbees.co.tz  
www.centralparkbees.co.tz

**TURKEY**

ApiMaye  
BÖSB, Birlık Sanayi Sitesi, Acelya Caddesi, Birlık  
3 Is Merkezi, No:12 Interior Door No: 1/1  
34520 Beylikuzu – Istanbul – Turkey  
tel. +90 212 876 7655  
fax: +90 2112 876 7654  
info@apimaye.com  
www.apimaye.com

**UKRAINE**

LYSON - UKRAINE "Ваша Пасіка"  
вул. Львівська 2, с. Наварія, Львівська  
область, Львівська обл., Україна, 81105  
tel. +38 050 370 35 35  
tel. +38 097 631-38-45  
тел/факс. +38 032 227-29-62  
info@vashapasika.com.ua  
www.vashapasika.com.ua

**UNITED ARAB EMIRATES**

Al Najeh Honey Sales  
The Prism Tower,  
office# 903 Bur Dubai, Business Bay, Dubai  
282225, UAE  
tel. +971 43 383339  
tel. +971 56 4996405  
info@anhb.ae  
www.anhb.ae  
www.alnajeh.ae

**UNITED KINGDOM**

Abelo Ltd  
Old Station Yard, Full Sutton, Common Road,  
Dunnington  
YORK, YO19 5EP  
tel. (+44) 01904 849331  
mob. (+44) 07508 944101  
sales@abelo.co.uk  
www.abelo.co.uk

Abelo of Scotland  
Caddon Foot, Clovenfords, TD1 3LG  
tel. (+44) 01904 849331  
sales@abelo.co.uk  
www.abelo.co.uk

**USA**

Betterbee  
8 Meader Road, Greenwich, NY 12834  
tel. 1-800-632-3379  
lyson@betterbee.com  
www.betterbee.com

**UZBEKISTAN**

LYSON  
000 "Khorizm Honey"  
tel. +998 93 745 07 07  
tel. +998 97 788 55 99  
rahmatilazariyov@lyson.com.pl

# WARRANTY PERIOD OF THE DEVICE

DEVICE CLASS / NAME	STEEL	CONTROLLER	MOTOR + GEAR	OTHER ELEMENTS
<b>HONEY EXTRACTOR</b>				
Premium	7		3	
Classic				
Optima				
Minima	5		2	
Basic				
<b>CREAMING</b>				
Premium	7		3	
Classic				
Optima				
Creaming tank with water jacket W7056MK, W7057MK	5		2	
<b>HONEY EXTRACTION LINE</b>				
40-frame and 100-frame honey extraction line	7		3	
<b>UNCAPPING MACHINE</b>				
Premium	7		3	
Classic				
Minima				
Vertical manual uncapping machine W2091, W2091S	5		2	
Overlay uncapping tables				
Pneumatic frame ejector				
<b>UNCAPPING TABLE</b>				
Classic			3	
Multifunctional tables – W4037_AB, W4039_AB				
Optima	5		2	
Uncapping tray				2
Cover , Heating Cover				2
<b>EXTRUDERS</b>				
Classic	5		3	
Optima			2	
<b>HONEY DECRYSTALLIZATION EQUIPMENT</b>				
Decrystallization chamber – W204100, W204100A, W40780, W40781				
Conical coil – W32010				
Optima decrystallization coil – W3207_OL, W3208_OL, W3210_OL	5		2	
Stand for coil – W3500101				
Hive body heater W3012				
Pollen dryer and decrystallization chamber combined – W32591, W32592, W32593				
Electronic temperature regulator MHC-01		3		
Decrystallization coil – W3207, W3208, W3210				2
<b>POLLEN PROCESSING EQUIPMENT</b>				
Pollen dryer – W3258C, W3258D, W3262000, W326200, W3260	5		2	
Pollen cleaner – W3217, W3216, W3219				
Pollen cleaner – W3213				
<b>HONEY DEHYDRATORS</b>				
Honey dryer - W4020, W4021, W4023 W4024, W4025, W4027	7		3	
Option for dryer W4020 or W4021- condensing aggregate	5			2
<b>HONEY SUMPS</b>				
Honey sumps: W2084, W2082A, W2081A, W2081				
Honey filter on the barrel W370			2	
Filter W360	5			
Stainless steel sieve - W7022, W7021, W7020, W7023, W7025, W7026, W7043				
W7030, W7031, W7042				
<b>HONEY PUMP</b>				
Compact version: W2021G400, W2021G230, W2022NZ, W2022NZ230				
Vertical auger pump - W20210S	5		2	
Honey pump W2021GN, W20210GN, W2021GNF, W20210GNF				

WARRANTY

DEVICE CLASS / NAME	STEEL	CONTROLLER	MOTOR + GEAR	OTHER ELEMENTS			
<b>STAINLESS STEEL TANKS</b>							
Stainless steel tanks: W852, W852P, W852M W852MP, W853, W853P, W853M, W853MP	7	3					
Premium Line				3			
Premium Stainless steel settling tank with heated drum		3					
Stainless steel tank - 500 - 1200 kg W856, W857, W858, W859, W7051, W7052	5	2		2			
Water - jacketed stainless steel bottling tank W7056, W7057, W7056MK, W7057MK		2					
Stainless steel syrup mixer W0136, W0137, W856M, W858M, W858MP, W856MP		2					
Transparent settling tank W5020		2		2			
Barrel 200L W7016							
Settling tank Optima Line							
Settling tank Classic Line							
Stainless steel settling tank with heated drum		3		2			
Cascade sieve with cover, with electronic honey level sensor		2					
<b>MULTIFUNCTIONAL EQUIPMENT</b>							
Multifunctional dosing unit – W204003, W204003Z, W204002P, W204002PZ, W204006	7						
Filling line – W204004							
Multifunctional dosing unit with gear module – W204001Z, W204002Z	5				3		
Multifunctional unit with silicone module – W204001, W204002							
Multifunctional unit with rotating table and silicone module - W204012, W204013, W204002							
Multifunctional machine with rotary table and gear module - W204012Z, W204013Z, W204002Z							
Dosing multifunctional unit – W204001O					2		
Manual dispenser – W2045							2
Manual dosing valve – W4010, W4010Z							
Pneumatic dosing valve – W4011, W4011Z							
<b>WAX MELTERS</b>							
Stainless wax melter - W4076, W4075, W4076O, W4075UW, W4076UW, W4072, W4072_O, W4097P, W4081, W4074, W4074A, W4090, W4099_SET, W4805, W4077, W4096W, W4097W, W7053, W7053_230V, W4805_O, W7054	5		2				
Solar wax melters - W3249, W3200TD, W3248A, W3247, 9131, W3246, W3250, W3251	5			2			
<b>OTHER EQUIPMENT</b>							
Transporting trolley for creaming machine	5			2			
Hose clamps							
Settling tank pad with jar stand							
Stainless steel stand for conical sieve							
Heating covers							
Honey level sensor							
Wax sterilizer – W7058P, W7064P		2					
Queen-rearing incubator – W5014							
Capping spinner W4800							
230V to 12V power supply – W3305							
Screw conveyor – W20971							
Bee sweeping devices – W30342, W30343, W30341			2				
W20670, W4510, W380							
Wax separator W4850_O, W4850							
Optima hive scales							
Premium scale, platform scale			3				
Professional capping spinner – W4801							
Honey loosener 30281					2		
Settling tank stands							
Premium stainless steel furniture for apiary workshops - W933_P, W934_P, W935_P	7			3			
Stainless steel furniture for apiary workshops W920, W921, W922, W923, W924, W925, W926, W927, W928, W929, W930, W931, W932, W919	5			2			
Hives + components		2					
Beekeeping Accessories		1					
Beekeeping Clothing		1					
Silicone Molds		1					

# VISIT OUR WEBSITE

[WWW.LYSON.EU](http://WWW.LYSON.EU)

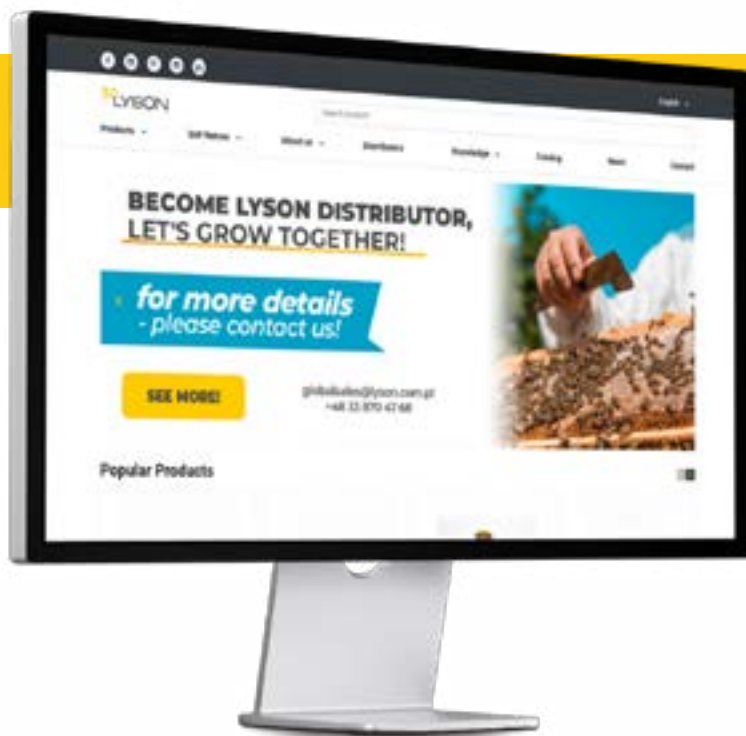

SCAN CODE QR



## TAKE A LOOK AND FOLLOW US ON SOCIAL MEDIA

 @forbeekeepers



 @lysoninternational



 @grupalyson



 @lyson

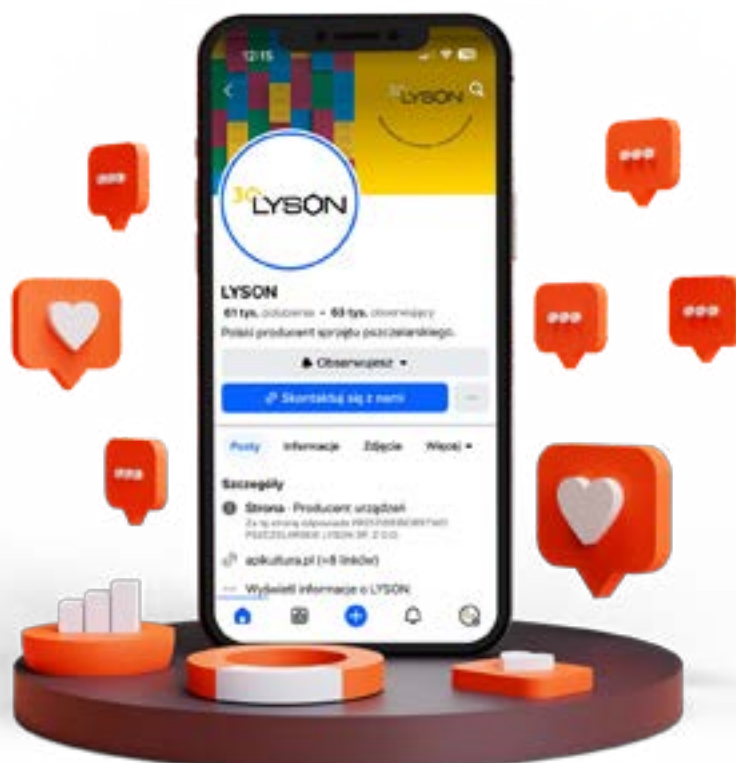

# LYSON'S MEMORIES

## FROM THE LAST 20 YEARS OF APIMONDIA



PLATINUM SPONSOR OF  
49<sup>th</sup> International Congress  
Apimondia 2025 Copenhagen





LYSON

Canada

USA

Chile

Republic of South Africa

Nigeria

Tanzania

Saudi Arabia

United Arab Emirates

South Korea

Japan

Australia

New Zealand

LYSON  
Poland

Sweden

Finland

Norway

Denmark

Estonia

Latvia

Lithuania

United Kingdom

Ireland

Netherlands

Belgium

Germany

France

Austria

Switzerland

Slovenia

Croatia

Italy

Spain

Portugal

Morocco

Greece

Czech Republic

Slovakia

Hungary

Moldova

Romania

Bulgaria

Turkey

Cyprus

Syria

Lebanon

Israel

Kuwait

Ukraine

Kazakhstan

Uzbekistan

Georgia

Armenia

**30** LYSON

**For 30 Years – Your Bees, Our Passion!**

**BILLING DETAILS**

Przedsiębiorstwo Pszczelarskie Łysoń Sp. z o.o.  
Pszczela 2, 34-124 Klecza Dolna, Poland  
NIP: 551-260-51-86

**OFFICE**

Przedsiębiorstwo Pszczelarskie Łysoń Sp. z o.o.  
Pszczela 2, 34-124 Klecza Dolna, Poland

**LOGISTIC**

Przedsiębiorstwo Pszczelarskie Łysoń Sp. z o.o.  
Miodowa 15, 34-124 Klecza Dolna, Poland

**DIRECT NUMBER TO EXPORT DEPARTMENT**

+48 33 875 99 40  
globalsales@lyson.com.pl

**LYSON POLAND**

[www.lyson.eu](http://www.lyson.eu)

